



УНИВЕРЗИТЕТ У НОВОМ САДУ
ФАКУЛТЕТ ТЕХНИЧКИХ НАУКА У
НОВОМ САДУ



Александра Вуковић Рукавина

**Електронски систем препознавања врсте
течности, применом интердигиталног
кондензатора**

ДОКТОРСКА ДИСЕРТАЦИЈА

Нови Сад, 2015.



КЉУЧНА ДОКУМЕНТАЦИЈСКА ИНФОРМАЦИЈА

Редни број, РБР:		
Идентификациони број, ИБР:		
Тип документације, ТД:	Монографска публикација	
Тип записа, ТЗ:	Текстуални штампани материјал	
Врста рада, ВР:	Докторска дисертација	
Аутор, АУ:	Александра Вуковић Рукавина, мастер	
Ментор, МН:	Проф. др. Милош Живанов, редовни професор	
Наслов рада, НР:	Електронски систем препознавања врсте течности, применом интердигиталног кондензатора	
Језик публикације, ЈП:	Енглески	
Језик извода, ЈИ:	Енглески/Српски	
Земља публиковања, ЗП:	Србија	
Уже географско подручје, УГП:	Војводина	
Година, ГО:	2015.	
Издавач, ИЗ:	Ауторски репринт	
Место и адреса, МА:	Факултет техничких наука, Трг Доситеја Обрадовића 6, 21000 Нови Сад	
Физички опис рада, ФО: (поглавља/страна/ цитата/табела/слика/графика/прилога)	7/1176/133/2/28/21/1	
Научна област, НО:	Електротехника	
Научна дисциплина, НД:	Примењена електроника	
Предметна одредница/Кључне речи, ПО:	диелектрична пермитивност; мерење пермитивности; интердигитални кондензатор; неинвазивни сензори; померај фреквенције; микроконтролер; РС232	
УДК		
Чува се, ЧУ:	Библиотека Факултета техничких наука, Трг Доситеја Обрадовића 6, 21000 Нови Сад	
Важна напомена, ВН:		
Извод, ИЗ:	Коришћењем интердигиталног кондензатора и микроконтролера, систем за препознавање течности је имплементиран и испитан. Пермитивност течних узорака је коришћена као физичка особина на основу које се врши препознавање. Инвазивна и неинвазивна конфигурација сензора је израђена и испитана. Резултати указују на могућност развоја компактних, минијатурних уређаја за теренску употребу.	
Датум прихватања теме, ДП:	15.12.2014.	
Датум одбране, ДО:		
Чланови комисије, КО:	Председник: Др. Ласло Нађ, редовни професор	Потпис ментора
	Члан: Др. Владимир Црнојевић, редовни професор	
	Члан: Др. Весна Црнојевић-Бенгин, ванредни професор	
	Члан: Др. Александар Менићанин, научни сарадник	
	Ментор: Др. Милош Живанов, редовни професор	



KEY WORDS DOCUMENTATION

Accession number, ANO :		
Identification number, INO :		
Document type, DT :	Monographic publication	
Type of record, TR :	Textual material, printed	
Contents code, CC :	PhD thesis	
Author, AU :	Aleksandra Vuković Rukavina, M. Sc.	
Mentor, MN :	Dr. Miloš Živanov, full professor	
Title, TI :	Electronic system for liquid-type recognition, based on interdigital capacitor	
Language of text, LT :	English	
Language of abstract, LA :	English/Serbian	
Country of publication, CP :	Serbia	
Locality of publication, LP :	Vojvodina	
Publication year, PY :	2015.	
Publisher, PB :	Author's reprint	
Publication place, PP :	Faculty of Technical Sciences, Trg Dositeja Obradovića 6, 21000 Novi Sad	
Physical description, PD : (chapters/pages/ref./tables/pictures/graphs/appendixes)	7/117/133/2/28/21/1	
Scientific field, SF :	Electrical engineering	
Scientific discipline, SD :	Applied electronics	
Subject/Key words, S/KW :	dielectric permittivity; permittivity measurement; interdigital capacitor; non-invasive sensors; frequency shift; microcontroller; RS232;	
UC		
Holding data, HD :	Library of the Faculty of technical sciences, Trg Dositeja Obradovića 6, 21000 Novi Sad	
Note, N :		
Abstract, AB :	By using interdigital capacitor and a microcontroller, a system for liquid-type recognition has been developed and examined. Permittivity of liquid samples has been used as a physical property for recognition. Invasive and non-invasive sensor configuration has been implemented and examined. Results imply the possibility to develop compact, miniature, on-field devices.	
Accepted by the Scientific Board on, ASB :	15.12.2014.	
Defended on, DE :		
Defended Board, DB :		
President:	Dr. Laslo Nađ, full professor	Mentor's sign
Member:	Dr. Vladimir Crnojević, full professor	
Member:	Dr. Vesna Crnojević-Bengin, associate professor	
Member:	Dr. Aleksandar Meničanin, research associate	
Mentor:	Dr. Miloš Živanov, full professor	

Dedicated

to my mother...

CONTENT

ACKNOWLEDGMENT	1
ПРОШИРЕНИ ИЗВОД ДОКТОРСКЕ ТЕЗЕ	2
КЉУЧНЕ РЕЧИ:	14
EXTENDED ABSTRACT OF THE DOCTORAL THESIS	15
KEY WORDS:	26
TABLES LIST	27
FIGURES LIST	28
GRAPHS LIST.....	30
LIST OF ABBREVIATIONS:	31
1 INTRODUCTION.....	32
2 DIELECTRIC PROPERTIES OF A SUBSTANCE	38
2.1 INTRODUCTION	38
2.2 PERMITTIVITY MEASUREMENT	42
3 CAPACITANCE AND DIELECTRICS	45
3.1 INTERDIGITAL CAPACITOR	46
3.2 ANALYSIS OF IDC'S PHYSICAL MODEL	48
3.2.1 <i>Parallel Partial Capacitance</i>	50
3.2.1.1 Computation of C_1	50
3.2.1.2 Computation of C_E	52
3.2.1.3 Computation of C_1 in the limiting case.....	54
3.2.1.4 Computation of C_E in the limiting case	54
3.2.2 <i>Serial Partial Capacitance</i>	56
3.2.2.1 Computation of C_1	56
3.2.2.2 Computation of C_E	57
3.3 DESIGN OF INTERDIGITAL CAPACITOR	58
3.3.1 <i>Invasive method sensor design</i>	62
3.3.2 <i>Non-invasive method sensor design</i>	62
4 LIQUID RECOGNITION SYSTEM DEVELOPMENT.....	65
4.1 INTERDIGITAL DIELECTROMETRY	65
4.2 MICROCONTROLLER DSPIC30F4013	66
4.3 CAPACITANCE MEASUREMENT	68
4.3.1 <i>Capacitance to frequency conversion</i>	71
4.4 FREQUENCY MEASUREMENT METHODS.....	73
4.4.1 <i>Reverse frequency measuring</i>	73
4.4.2 <i>Direct frequency measuring</i>	74
5 INVASIVE RECOGNITION MECHANISM.....	76
5.1 MICROCONTROLLER PROGRAMMING AND CALIBRATION	78
5.2 PERFORMANCE RESULTS.....	82
6 NON-INVASIVE DETECTION MECHANISM.....	86
6.1 MICROCONTROLLER PROGRAMMING AND CALIBRATION	87
6.2 PERFORMANCE RESULTS.....	90

7	THESIS SUMMARY AND FUTURE WORK	94
	REFERENCES	97
	VITAE.....	111
	APPENDIX 1.....	112

САДРЖАЈ

ACKNOWLEDGMENT	1
ПРОШИРЕНИ ИЗВОД ДОКТОРСКЕ ТЕЗЕ	2
КЉУЧНЕ РЕЧИ:	14
EXTENDED ABSTRACT OF THE DOCTORAL THESIS	15
KEY WORDS:	26
СПИСАК ТАБЕЛА	27
СПИСАК СЛИКА	28
СПИСАК ГРАФИКА	30
СПИСАК СКРАЋЕНИЦА:	31
1 УВОД	32
2 ДИЕЛЕКТРИЧНЕ ОСОБИНЕ СУПСТАНЦЕ	38
2.1 УВОД.....	38
2.2 МЕРЕЊЕ ПЕРМИТИВНОСТИ	42
3 КАПАЦИТИВНОСТ И ДИЕЛЕКТРИЦИ	45
3.1 ИНТЕРДИГИТАЛНИ КОНДЕНЗАТОР	46
3.2 АНАЛИЗА ФИЗИЧКОГ МОДЕЛА ИНТЕРДИГИТАЛНОГ КОНДЕНЗАТОРА.....	48
3.2.1 <i>Паралелна Парцијална Капацитивност</i>	50
3.2.1.1 Рачунање C_1	50
3.2.1.2 Рачунање C_E	52
3.2.1.3 Рачунање C_1 у граничном случају	54
3.2.1.4 Рачунање C_E у граничном случају	54
3.2.2 <i>Серијска Парцијална капацитивност</i>	56
3.2.2.1 Рачунање C_1	56
3.2.2.2 Рачунање C_E	57
3.3 ДИЗАЈН ИНТЕРДИГИТАЛНОГ КОНДЕНЗАТОРА	58
3.3.1 <i>Дизајнирање сензора за инвазивни метод</i>	62
3.3.2 <i>Дизајнирање сензора за неинвазивни метод</i>	62
4 РАЗВОЈ СИСТЕМА ЗА ПРЕПОЗНАВАЊЕ ТЕЧНОСТИ	65
4.1 ИНТЕРДИГИТАЛНА ДИЕЛЕКТРОМЕТРИЈА	65
4.2 МИКРОКОНТРОЛЕР DSPIC30F4013	66
4.3 МЕРЕЊЕ КАПАЦИТИВНОСТИ.....	68
4.3.1 <i>Конверзија капацитивности у фреквенцију</i>	71
4.4 МЕТОДЕ МЕРЕЊА ФРЕКВЕНЦИЈЕ.....	73
4.4.1 <i>Инверзно мерење фреквенције</i>	73
4.4.2 <i>Директно мерење фреквенције</i>	74
5 ИНВАЗИВНИ МЕХАНИЗАМ ПРЕПОЗНАВАЊА	76
5.1 ПРОГРАМИРАЊЕ МИКРОКОНТРОЛЕРА И КАЛИБРАЦИЈА	78
5.2 РЕЗУЛТАТИ РАДА	82
6 НЕИНВАЗИВНИ МЕХАНИЗАМ ПРЕПОЗНАВАЊА	86
6.1 ПРОГРАМИРАЊЕ МИКРОКОНТРОЛЕРА И КАЛИБРАЦИЈА	87
6.2 РЕЗУЛТАТИ РАДА	90
7 РЕЗИМЕ ТЕЗЕ И БУДУЋИ РАЗВОЈ	94

РЕФЕРЕНЦЕ	97
VIТАЕ.....	111
ДОДАТАК 1	112

ACKNOWLEDGMENT

This work has been supported by Ministry of Education, Science and Technical Development, Republic of Serbia, through scholarship gained on project III 43008.

ПРОШИРЕНИ ИЗВОД ДОКТОРСКЕ ТЕЗЕ

Електронски систем препознавања врсте течности, применом интердигиталног кондензатора

Александра Вуковић Рукавина

Факултет техничких наука, Универзитет у Новом Саду

2015.

Развој и примена метода и инструментације у анализи било које супстанце има за циљ добијање корисних информација о датом узорку. Аналитичке методе анализе се генерално деле на класичне и инструменталне. Класичне методе се састоје од припремних метода за пречишћавање узорака и квалитативне анализе физичких особина пошто се поуздана анализа може вршити само на чистим узорцима. У квалитативној анализи изводе се мерења запремине и масе узорака.

Инструменталне методе употребљавају инструментацију у процесу мерења физичких особина уз коришћење бројних метода пречишћавања узорака. Као генерално правило за одабир приступа у анализи узорка потребно је одредити да ли је узорак елемент или једињење. Ако је у питању елемент, нека од спектроскопских метода је најпогоднија. Ако је у питању једињење, потребно је утврдити да ли је једињење мешавина или је у питању чист производ.

Могућност мерења особина материјала је веома важна за велики број апликација. Могућност недеструктивног праћења физичких или хемијских промена налази примену у индустрији, медицини и науци. Чиста супстанца се

може анализирати поређењем њених физичких особина са референтним стандардима. Маса и запремина зависе од количине узорка и нису погодне за коришћење у процесима идентификације супстанци. Боја, густина, тачка замрзавања и кључања, растворљивост и индекс преламања су јединствене карактеристике сваке супстанце и одређивање ових параметара омогућава идентификацију непознатог узорка.

За мали број узорака, уобичаено је да се употребљавају класичне лабораторијске методе анализе. Физичке особине чистих супстанци се увек наводе у литератури доступној у лабораторијама и научним библиотекама. Поређењем резултата испитивања узорка са датим стандардима могуће је предпоставити идентитет.

Како је претходно описано, за идентификацију узорка потребно је утврдити одређен број особина, да би се узорак класификовао. Овај процес може бити временски захтеван или неодговарајући ако је процес потребно спровести изван лабораторије или је узорак токсичан и опасан за оператера. Експериментална наука користи знање више дисциплина и ослања се на разне феномене да би се развили инструменти који би овај процес поједноставили и учинили га безбедним за оператера.

Инструменталне методе, у данашње време, доминирају у већини области науке и технологије. У поређењу са класичним методама, овај приступ даје брзину, осетљивост и аутоматски рад. У свим областима, важне одлуке, решења проблема и напредак су базирани на инструменталним методама. Модерна инструментација омогућава рутинску анализу и идентификацију непознатих супстанци. Спектроскопија, масена спектрометрија, електрохемијске и термалне анализе, као и разноврсне хибридне технике као комбинација претходних метода, представљају неке од најчешћих инструменталних приступа. Проблем код инструменталних метода су висока цена, потребни лабораторијски услови рада, време и цена одржавања и калибрације. Због свега

овог, инструменталне методе се углавном користе за анализирање великог броја сличних узорака, јер тада анализа постаје приступачна и релативно брза.

Минијатуризација хемијских и биолошких сензора привлачи све више пажње у медицинској дијагностици, заштити животне средине, фармацији и у војним апликацијама.

Интересантна област научног развоја представља систем мерења диелектричних особина где је могуће добити информацију о проводности и пермитивности узорка. Из угла електромагнетне теорије, одзив вектора електричног помераја било које супстанце, на променљиво електрично поље, дефинисано је функцијом диелектричне пермитивности ϵ . Ова величина је одређена интерном динамиком молекула. Пропагација електромагнетних таласа одређује се помоћу Максвелових једначина. Диелектрични материјал представља изолатор који се може поларизовати помоћу електричног побудног поља. Носиоци наелектрисања се померају из просечног равнотежног стања узрокујући диелектричну поларизацију размештајући позитивне и негативне носиоце у супротним смеровима. Овај процес ствара интерно електрично поље које слаби спољашњу побуду. Јонска, оријентациона, атомска, електронска и просторна поларизација представљају неке од механизма који се могу посматрати. Сваки механизам има своју карактеристичну амплитуду и фреквенцију на којој достиже максимум, јединствену за сваки материјал. Са повећањем фреквенције, само брзи механизми доприносе пермитивности. Оваква особина представља јединствену карактеристику сваког материјала и проучавање овог феномена представља диелектричну спектроскопију. Ово упућује на идентификацију супстанце мерењем овог параметра и поређењем са референтним податцима.

Поуздана мерења диелектричних особина налазе примену у многим апликацијама. Диелектричне особине могу бити утврђене коришћењем електромагнетних таласа. У основи постоје два приступа мерењу диелектричних особина: методе са употребом ниских и високих фреквенција побудних

електричних поља. Методе које користе ниске фреквенције могу бити спроведене у фреквентном или временском домену. Технике мерења у временском домену користе волтаметријске, галванометријске, и мостне методе. У овом приступу користи се степ промена побудног електричног поља и временски зависна диелектрична функција може бити посматрана у временском домену. Технике мерења на високим фреквенцијама се деле на резонантне и нерезонантне технике од којих су поједине погодније за изолаторе, док су неке боље за примену на узорцима са већим губитцима. Већина свих техника је применљива и на чврсте и течне узорке. Диелектричне особине течних узорака имају велики потенцијал за примену у индустрији, медицини и заштити животне средине. Генерално избор методе мора разматрати очекивану пермитивност, тачност, особине узорка, количину узорка као деструктивност.

Диелектрометрија представља веома важан метод за карактеризацију материјала. Овај приступ користи мерење капацитивности за добијање диелектричних особина узорка. Пошто се промене ових особина могу повезати са променом физичких, хемијских или структурних промена материјала, диелектрометрија даје добре резултате при недеструктивној евалуацији виталних параметара у индустријским и научним апликацијама.

Већина сензора коришћена у диелектрометрији су по природи капацитивни. Капацитивни сензори имају предност због тачности и неинвазивности. Најпростији пример оваквог сензора је плочасти кондензатор док постоје и компликованије геометрије. Интердигитална диелектрометрија се користи за мерење диелектричних особина материјала коришћењем интердигиталног кондензатора као капацитивног сензора.

Интердигитални кондензатор представља периодичну, планарну, чешљасту структуру. Периодичност се користи за повећање капацитивности ових сензора на рачун електричног поља које продире у узорак. У зависности од конфигурације електрода електрично поље може продрати дубље у узорак и

тима повећавати капацитивност. Типичан интердигитални кондензатор је направљен од инертног супстрата на који се наноси чешљаста структура електрода (Слика 1). Најбоља особина ових сензора је једностранни приступ узорку. Електрично, магнетно или акуустично поље је могуће применити са једне стране узорка, остављајући другу страну отворену за утицај околине, апсорпцију гаса, влаге или хемикалија које мењају особине узорка.

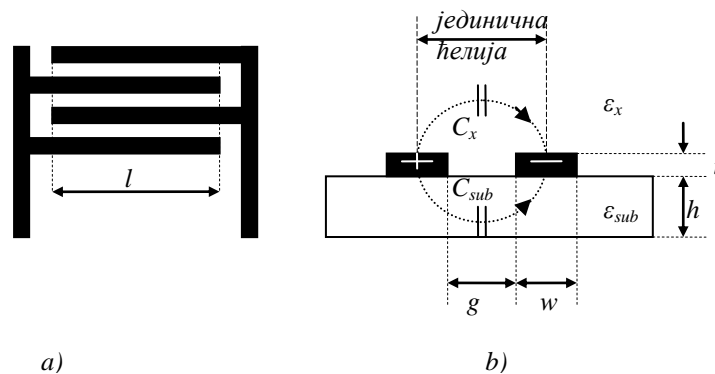

Слика 1: IDC: а) планарна структура, б) попречни пресек (l – дужина прстију, h – висина коришћеног супстрата, t – дебљина проводног материјала коришћеног за електроде, ϵ_{sub} – пермитивност супстрата, ϵ_x – пермитивност узорка, g – размак између електрода, w – ширина електрода, C_x – капацитивност узорка, C_{sub} – капацитивност супстрата)

Интердигитални хемијски сензори користе хемијски осетљиве слојеве чија проводност и пермитивност зависи од употребљеног узорка и на тај начин мењају капацитивност сензора. Променом површине сензора, броја прстију и размака између електрода, снага излазног сигнала се може контролисати према захтевима апликације.

Интердигитални сензори су предмет истраживања великог броја научника и налазе своју примену у разним областима јер су приступачни, једноставни за израду и интеграцију уз разне компоненте и интерфејсну електронику. Велику ману ових сензора представља непостојање аналитичких једначина које би се

користиле за предвиђање електричног одзива. Корисну методу за рачунање капацитивности интердигиталних структура представља конформално мапирање које даје једначине базиране на геометрији и физичким карактеристикама сензора. Постоје разни модели применљиви за разне конфигурације и геометрије сензора, док је у овој тези искоришћен модел који је развио Igreja у [87] и [88]. Дат је преглед и начин извођења једначина. Дат је приказ теоријских рачунања капацитивности кондензатора у зависности од промене одређених параметара.

Капацитивни сензори могу бити израђени у инвазивној и неинвазивној конфигурацији. Инвазивна конфигурација подразумева директан контакт између металних електрода и узорка док у неинвазивном случају контакт између узорка у електрода не постоји већ се одвија преко стаклених и полипропиленских посуда. У овој тези су испитане обе конфигурације у процесу идентификације течних узорака. На основу резултата рачунања и разматрања карактеристика посуда, дизајнирани су различити капацитивни сензори.

За инвазивну конфигурацију дизајнирана су два сензора на FR-4 плочи. Једна структура је израђена са 8 прстију, дужином прста од 37mm, ширином прста од 0.7mm и размаком међу прстима од 0.5mm. Другој структури је промењена дужина прстију на 9.5mm и број прстију на 16, док су остали параметри остали исти.

За неинвазивну конфигурацију спроведено је разматрање у складу са посудама који ће бити коришћени за паковање узорака. Узимајући у обзир геометрију посуда, структура на FR-2 плочи је израђена са 7 прстију, дужином прстију од 37.5mm, ширином прстију од 4mm и размаком од 0.5mm.

У току извођења експериментата примећено је да узорци који брзо испаравају (бензен, ацетон и етанол) мењају особине ако процес мерења потраје. Да би се ово избегло коришћени су полипропиленски шприцеви за паковање узорака. Флексибилна папирна структура је израђена према геометрији шприца

са 7 прстију, дужином прста од 28mm, ширином прста од 3mm и размаком међу прстима од 2mm.

Као основа система употребљен је микроконтролер dsPIC30f4013 који представља интеграцију централне процесорске јединице, меморије, периферија и не захтева компликован хардвер за реализацију комплетног система.

Разматране су методе мерења капацитивности погодне за употребу уз микроконтролер. Неке од могућих метода су пренос наелектрисања, мерење временске константе „RC“ кола као и употреба релаксационог осцилатора. Утврђено је да се за мале промене капацитивности користи конвертовање капацитивности у фреквенцију пошто мале промене узрокују релативно велике помераје у фреквенцији. Анализирано је тајмер коло TLC555 у астабилном режиму рада и дата је једначина за израчунавање фреквенције у зависности од капацитивности. Такође су размотрене директне и индиректне технике мерења фреквенције, и утврђено је да је директна метода погодија за примену, пошто су очекиване промене у kHz опсегу и микроконтролер је у могућности директног бројања импулса са тајмера, што знатно упрошћава и убрзава процес мерења.

На основу ових разматрања имплементорана су и испитана два система за препознавање течних узорака. Први приступ користи сензорску структуру на стандардној FR-4 PCB плочи и инвазивну конфигурацију сензора. Промена капацитивности ове структуре зависи од промене пермитивности медијума изнад IDC електрода, осликавајући особине употребљене течности. Коришћењем микроконтролера и тајмер кола, информација о врсти течности се приказује на дисплеју са 2×16 карактера и преко RS232 конекције на рачунар. Направљени прототип је тестиран на седам течности (бензен, фенол, ацетон, етанол, метанол, формалдехид и дестилована вода) и неутрално стање када је присутан само ваздух. Разматран је утицај резистивног дела капацитивности на резултате мерења и утврђена околност када се тај утицај може сматрати занемарљивим. Приказан је поступак мерења капацитивности узорака и калибрације. Такође, дати

су резултати препознавања седам узорака (Слика 2). Инвазивни приступ веома добро разликује седам течности уз могућност додавања још течности за препознавање. У овом експерименту предпостављено је да су узорци чисти и да је остварен услов за занемаривање резистивног дела капацитивности. Примећено је да се, у овом случају, боља резолуција и тачност постиже за узорцима нижих пермитивности.

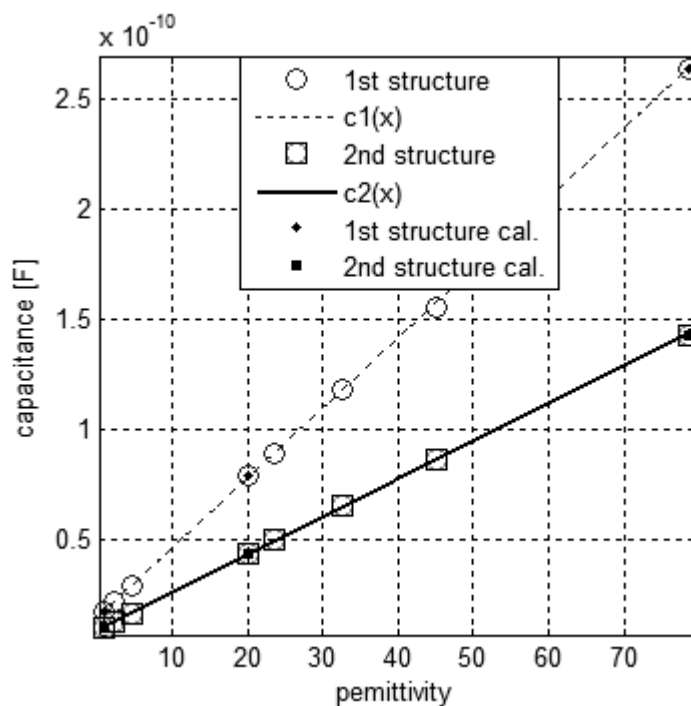

Слика 2: Поређење измерених капацитивности са израчунатим кох инвазивних мерења

Како неке течности испаравају и могу бити опасне због могућности тровања, циљ неинвазивног приступа препознавању узорака је испитивање могућности препознавање узорака пакованих у одређене посуде. Експерименти су се показали обећавајући у дизајнирању преносивих и приступачних сензорских уређаја за теренску употребу где је потребно разликовати мањи број пакованих узорака.

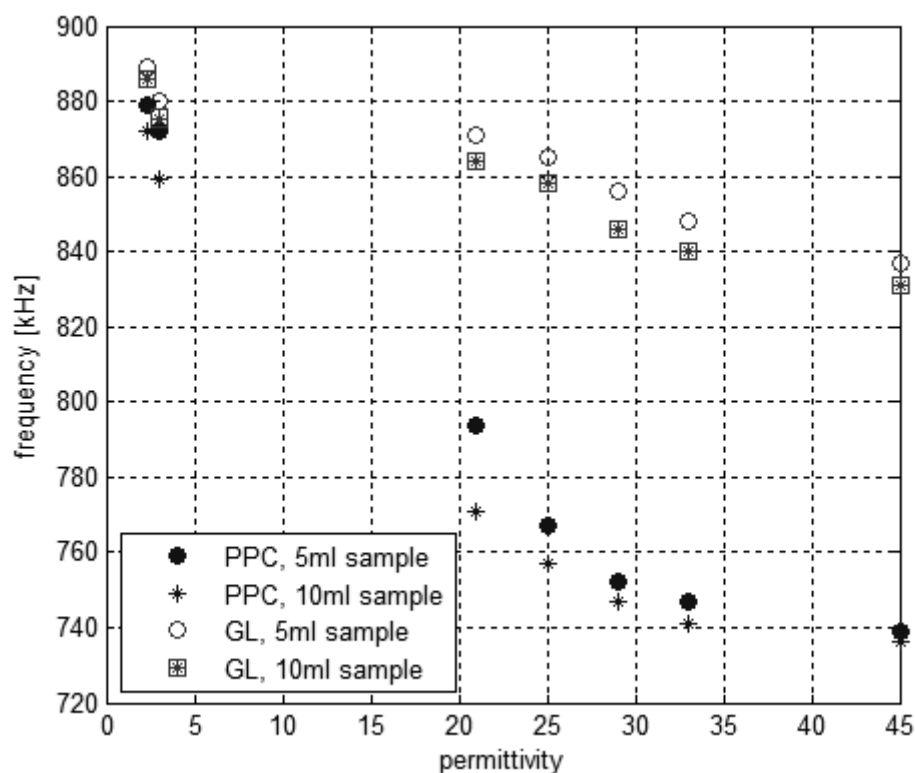

Слика 3: Измерена фреквенција за PPC и GL коришћењем чврстог IDC код неинвазивних мерења

Други приступ истражује могућност неинвазивног препознавања течних узорака пакованих у стаклене и полипропиленске спремнике. IDC структуре су дизајниране као чврсте (израђене коришћењем стандардне процедуре за фабрикацију FR-2 PCB-а) и флексибилне (папирне) структуре. Тестирање је обављено на узорцима бензена, маслиновог уља, алкохола, метанола, прочишћене воде и формалдехида. Испитана је запремина узорка и утицај посуда. Информација о узорку је доступна на дисплеју са 2×16 карактера и преко RS232 конекције на рачунару. Приказан је поступак мерења капацитвности и калибрације за стаклене и полипропиленске посуде уз коришћење PCB сензорске структуре (Слика 3) и приказан је резултат теста препознавања (Слика 4). Такође, поступак је спроведен и на полипропиленским шприцевима уз коришћење

папирне флексибилне сензорске структуре. Дати су резултати препознавања узорака за обе сензорске стурктуре и све коришћене посуде.

Посебна пажња је посвећена узорцима који брзо испаравају. У ту сврху су искоришћени полипропиленски шприцеви и флексибилна папирна сензорска структура. Неинвазивна сензорска конфигурација подразумева да се интеракција између електрода и узорка одвија преко посуде, тако да не постоји оштећење електрода а испаравање узорака. Резистивна компонента се може безбедно занемарити (Слика 5).

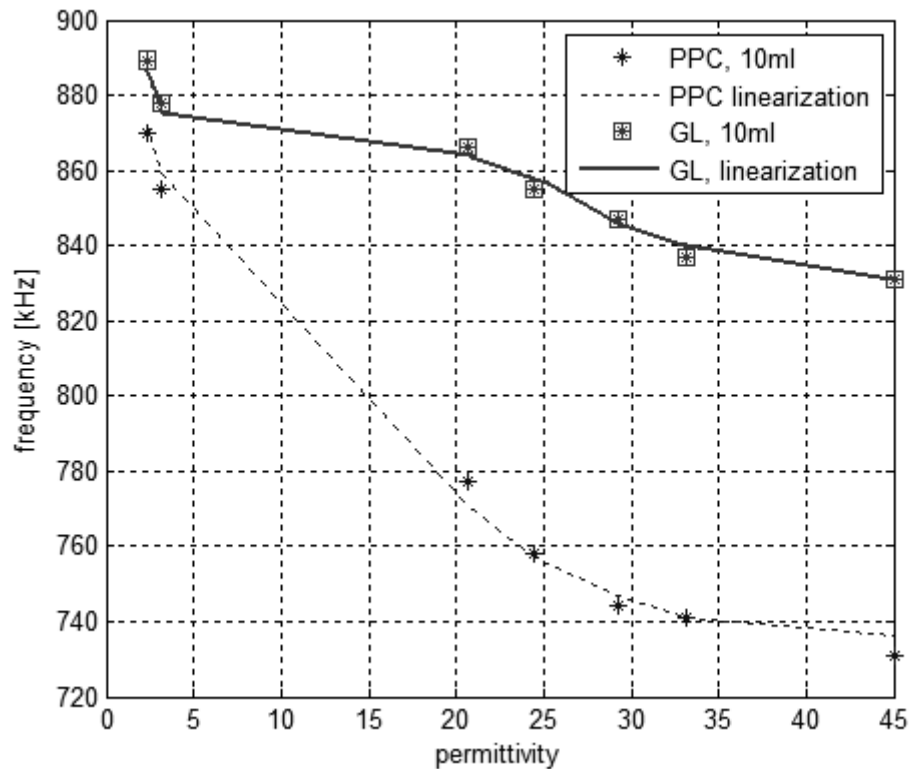

Слика 4: Резултат теста чврстог IDC код неинвазивних мерења

Поред ових предности, потребан је додатан опрез. Контактна површина између РСВ сензорске структуре и пода посуде, мора бити довољно глатка да би се постигли најбољи резултати. Такође, утврђено је да стаклене посуде имају

дебље подлоге због спречавања пуцања и оштећења. Ова додатна дебелина утиче на продирање електричног поља и због тога се осетљивост смањује.

Папирна сензорска структура се показала погоднијом за примену на зидовима посуда, који су генерално тањи и уједначеније стурктуре. Велики недостатак оваквог система је потреба за узимањем узорака у претходно дефинисане посуде и тачно одређене запремине. Тачно позиционирање посуда код чврстог IDC је такође важно питање.

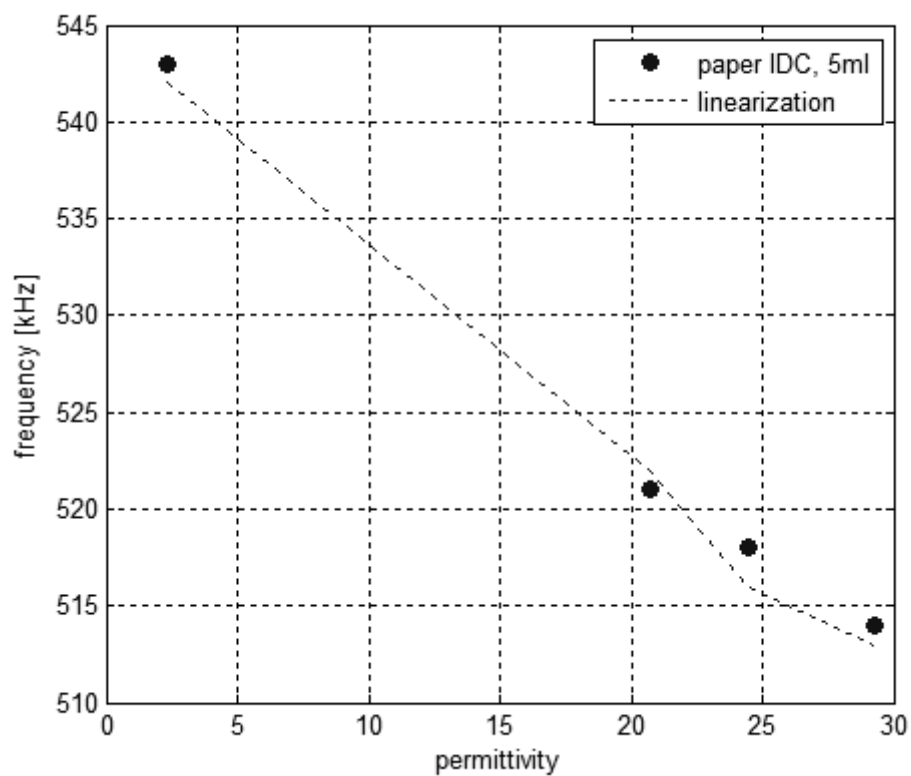

Слика 5: Резултат рада папирног IDC код неинвазивних мерења

Несигурност система у препознавању је испитана и експериментални резултати показују да је овакав систем у довољној мери способан да разликује течне узорке детектујући разлике у њиховој пермитивности. Неинвазивни приступ представља користан алат за анализу диелектричних особина течних узорака и задовољавајуће перформансе у распознавању малог броја узорака.

Потребна су даља проучавања и експерименти да би се постигла оптималнија резолуција и процесне способности у реалним околностима. Предлаже се побољшање геометрије сензорске структуре, трансформацијом сензорског елемента у „LC tag“ за употребу у бежичним апликацијама. Инвазивни приступ препознавања течности подразумева да су узорци чисти. Пошто резистивна компонента може постати значајна ако се течности контаминирају проводним нечистоћама предлаже се побољшавање у правцу даље имунизације на ове паразитне ефекте.

Предлаже се побољшање неинвазивног приступа додавањем аутоматског препознавања врсте посуде као и одређивање запремине узорка. Даље истраживање на флексибилним сензорским структурама је пожељно за примену оваквих система на цевоводима. Додатак додатних интерфејса као што је GSM модем може се искористити за алармирање ако се користе опасне супстанце.

Систем је могуће модификовати за потребу у заштити животне средине у праћењу квалитета воде. Стране супстанце стварају мешавине кад се нађу у води и на тај начин мењају њену пермитивност. Ова промена се може искористити као рано упозорење на загађење а додатак осетљивих слојева на електроде кондензатора који би реаговали на одређене супстанце омогућио би препознавање и које су супстанце присутне у мешавини. Предлажу се даља истраживања да би се утврдиле супстанце које имају погодну пермитивност и такође је потребно испитати најмање концентracије које би се на овај начин могле детектовати.

КЉУЧНЕ РЕЧИ:

диелектрична пермитивност; мерење пермитивности; интердигитални кондензатор; неинвазивни сензори; померај фреквенције; микроконтролер; РС232

EXTENDED ABSTRACT OF THE DOCTORAL THESIS

Electronic system for liquid-type recognition, based on interdigital capacitor

Aleksandra Vuković Rukavina

Faculty of technical sciences, University of Novi Sad

2015.

Development and application of methods and instrumentation in every substance analysis has its goal in obtaining useful information about the sample observed. Analytical methods are often divided into classical and instrumental. Classical methods consist of preparation methods for sample purification and qualitative analysis of physical properties since reliable analysis can be conducted only on pure samples. In quantitative analysis measurements of volume and mass are conducted.

Instrumental methods use instrumentation in the process of physical properties measurement with the help of numerous purification methods. As a general rule for selecting a suitable approach in sample analysis, it is necessary to determine whether a sample is an element or a compound. If it's an element, suitable atomic spectroscopy can be used. If it's a compound it is necessary to determine if the compound is pure or a mixture.

The possibility to measure materials properties is very important for a large number of applications. The possibility to non-destructively monitor physical or

chemical changes finds its application in industry, medicine and science. Pure substance can be recognized by comparison if its properties to reference standards. Mass and volume depend on sample amount and they are not suitable for recognition. Color, density, freezing and boiling point, solubility and refractive index, represent unique characteristics of each substance and determination of these parameters makes it possible to identify the unknown sample.

For low number of samples, it is common to use classical laboratory methods. Physical properties of pure substances are always described in literature available in labs and science libraries. Comparing of examined properties with these standards makes it possible to assume the identification.

As previously described, for sample identification, it is necessary to determine a certain number of properties in order to classify the sample. This process can be time consuming or inappropriate, if it is necessary to conduct it outside of a lab or a sample is toxic and represents danger for the operator. Experimental science uses knowledge of multiple science areas and relies on various phenomena in order to develop instrumentation to simplify this process and make it safe for the operator.

Instrumental methods dominate in most areas of science and technology. Compared to classical methods, they give speed, sensitivity and automatic work. In all areas, important decisions, problem solutions and advances are based on instrumental methods. Modern instrumentation assures a routine analysis and identification of unknown substances. Spectroscopy, mass spectrometry, electrochemical and thermal analysis as well as various hybrid techniques as a combination of previous methods, represent some of the frequently used instrumental approaches. The major problems with instruments used in these methods are high price, the necessity of lab working conditions, time and price for maintenance and calibration. Because of all this, instrumentation methods are mostly used for analysis of large number of similar samples, making this process affordable and fast.

Chemical and biological sensor miniaturization attracts attention in medical diagnostics, environmental monitoring, and pharmaceuticals as well as in military applications.

Interesting area of scientific development represents a dielectric properties measurement providing the information about the conductivity and permittivity of a sample. From the point of view of electromagnetic theory, the electric displacement field response of any substance to a rapidly varying electrical field is defined by a complex dielectric permittivity function ϵ . This property is determined by the internal dynamics of the molecules. Propagation of electromagnetic waves can be determined by using Maxwell's equations. Dielectric material represents an insulator that can be polarized with the use of the electric excitation field. Charge carriers are shifted from their equilibrium states, causing dielectric polarization and carrier movement in opposite directions. This process creates internal electric field that weakens the external field. Ionic, orientation, atomic, electronic and space charge polarizations represent some of the observable mechanisms. Each mechanism has its own characteristic magnitude and "cut off" frequency reaching its peak, unique for every material. With the frequency rise, only the fast mechanisms contribute to permittivity. This behavior represents a unique characteristic of every material and analysis of this phenomenon represents dielectric spectroscopy. This implies the substance identification by measuring this parameter and its comparison with reference data.

Reliable measurements of dielectric properties find their usage in many applications. Dielectric properties can be determined using electromagnetic waves. Basically, there are two common approaches to dielectric properties measurement: methods using low and high frequencies of excitation fields. Methods using low frequencies can be conducted in frequency or in time domain. Measurement techniques used in time domain, apply voltammetric, galvanometric and bridge methods. This approach uses step change of an excitation signal and time dependent dielectric function can be observed in time domain. Measurement techniques on high frequencies are divided into resonant and non-resonant techniques with some of them more suitable

for insulators and others for lossy materials. Most of these techniques are applicable on both solid and liquid samples. Dielectric properties of liquid samples find their potential in industry, medicine and environmental monitoring. In general, suitable method must consider expected permittivity, accuracy, sample properties, sample amount as well as destructivity.

Dielectrometry represents very important method for material characterization. This approach uses capacitance measurement for dielectric properties obtaining. Since this can be linked to changes in physical, chemical or structural changes of a material, dielectrometry gives good results in non-destructive vital parameter analysis in industrial as well as scientific applications.

Most of the sensors used in dielectrometry are capacitive in nature. Capacitive sensors have the advantage in accuracy and non-invasiveness. Simple example represents parallel plate capacitor while more complicated geometries are possible. Interdigital dielectrometry is used for dielectric properties measurement based on the interdigital capacitor.

Interdigital capacitor represents periodic, planar, comb structure. Periodicity is used for increasing the capacitance of these sensors at the expense of the amount of the electrical field penetration the sample. Electric field can penetrate deeper into the sample and increase the capacitance. Typical interdigital capacitor is made of an inert substrate with a comb structure of electrodes (Figure 1). The best characteristic of these sensors is in one-sided access. Electrical, magnetic or acoustic field is applicable from one side of the sample leaving its other side open for environmental influence, gas, humidity or chemical absorption that can change the samples properties.

Interdigital chemical sensors use chemically sensitive layers with changeable conductivity and permittivity based on the properties of the used sample, changing capacitance of the sensor. By changing the area of the sensor, finger number and space between electrodes it is possible to control the strength of the exit signal used.

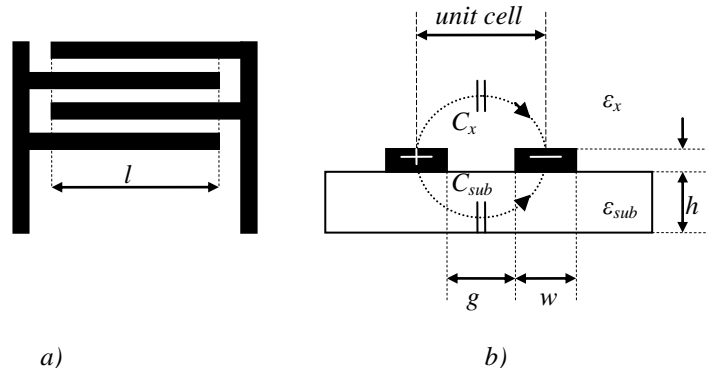

Figure 1: IDC: a) planar structure, b) cross-sectional view (l – length of the fingers, h – height of the substrate used, t – thickness of the conductive material forming electrodes, ϵ_{sub} – permittivity of substrate, ϵ_x – permittivity of MUT, g – electrode spacing, w – electrode width, C_x – MUT capacitance, C_{sub} – substrate capacitance)

Interdigital sensors are subject to research of many scientists and find their application and numerous areas because they are simple and suitable for integration with other components and interface electronics. Major disadvantage of these sensors represents the absence of analytical equations suitable for electrical response prediction. Useful method for interdigital capacitance calculation is conformal mapping, providing the equations based on geometry and physical characteristics of a sensor. There exist various models applicable for a number of applications, but in this thesis a model developed by Igreja in [87] and [88] is used. Equations and calculations are presented. Theoretical calculations of capacitance depending on parameter changes are obtained.

Capacitive sensors can be made in invasive and non-invasive configuration. Invasive configuration assumes direct contact between metal electrodes and samples, while in the non-invasive case interaction between the sample and the electrodes takes place over glass and polypropylene containers. In this thesis, both configurations have

been examined. Based on theoretical calculation and considering container characteristics, different sensors have been designed.

Invasive sensors were fabricated on FR-4 board. The 1st structure consists of 8 fingers, finger length 37mm, finger width 0.7mm and finger gap 0.5mm. The 2nd structure changes finger length into 9.5mm and finger number into 16.

For non-invasive configuration container characteristics were considered. Solid FR-2 sensor was fabricated with 7 fingers, finger length 37.5mm, finger width 4mm and finger gap 0.5mm.

During experiments it was established that vaporizable samples (benzene, acetone and ethanol) change their properties if the measurement process lasts. In order to avoid this polypropylene syringes were used for sample packing. Flexible paper structure was fabricated with 7 fingers, finger length 28mm, finger width 3mm and finger gap 2mm.

As the system's base a microcontroller dsPIC30f4013 was used, representing integrated central processing unit, memory and peripherals with simple additional hardware requirements for a complete systems development.

Capacitance measurement methods, suitable for microcontroller applications were considered. Some of the possibilities were charge transfer, RC time constant measurement and relaxation oscillator usage. Small changes in capacitance cause large shifts in frequencies and capacitance to frequency conversion is applicable. Timer TLC555 was analyzed and the equation for output frequency given. Also, direct and reverse frequency measurement techniques were considered and it was established that direct method is better since the expected changes are in kHz region. Microcontroller can count the pulses directly thus making the process simple and fast.

Based on these considerations, two systems were implemented and examined. First approach employs sensor's structure fabricated on standard FR-4 PCB board. Its capacitance change relies upon permittivity change of the medium above IDC

electrodes, representing dielectric properties of the liquid used. Along with the microcontroller and simple interface circuit, information about the type of the liquid is presented on a 2×16 character display and through RS232 connection on PC. Implemented unit was tested against seven liquids (benzene, phenol, acetone, ethanol, methanol, formaldehyde and distilled water) and a steady state when unit only detected air. Resistive part of the capacitance was considered and its affect to measurement result as well as the case when this influence can be considered negligible. Capacitance measurement and calibration is performed and performance results presented (Figure 2). Invasive approach discriminates seven liquids with the possibility to add more liquids for recognition. In this experiment it was assumed that the liquids are pure and resistive part negligible. In this case better resolution was achiever with low permittivity samples.

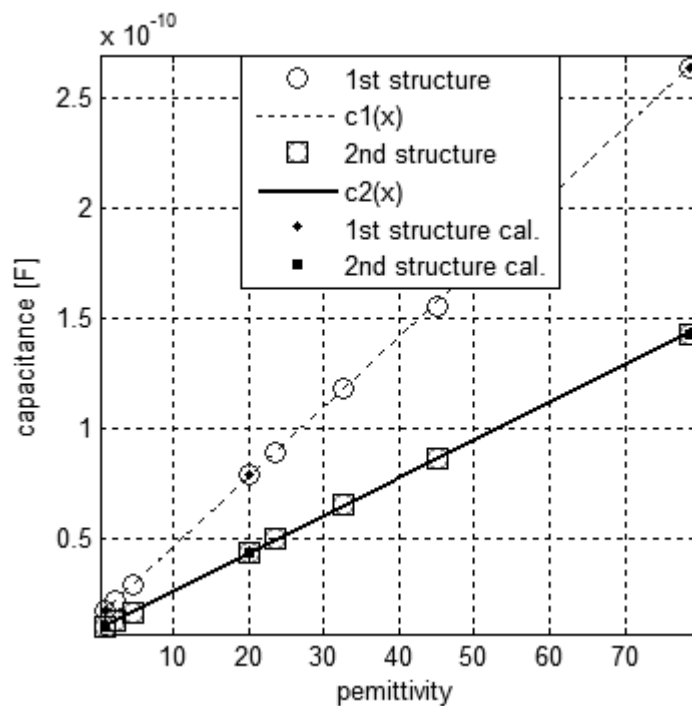

Figure 2: Comparison of extracted capacitance against computed fit in invasive approach

As some of the substances deteriorate and can be dangerous to handle due to possibility of intoxication of the operator, the purpose of non-invasive approach was to

investigate the possibility to recognize samples packed in predefined containers. Experiments showed promising in building a portable and cost-effective sensing unit for on-field application where it is necessary to discriminate between several packed liquid samples.

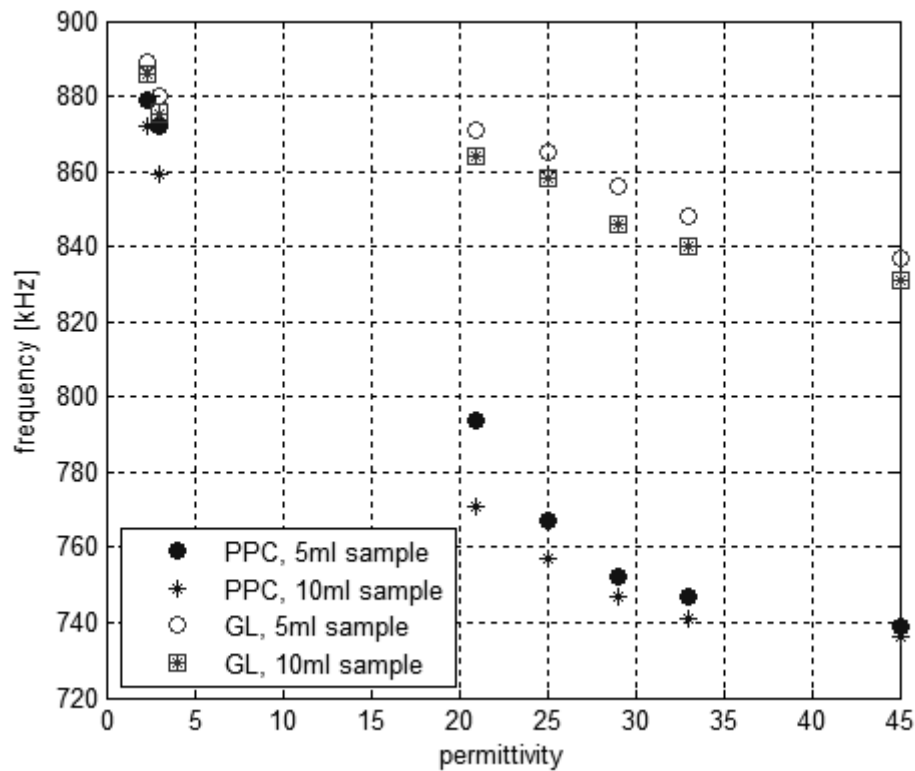

Figure 3: Frequency readings for PPC and GL using solid IDC in non-invasive approach

In second approach we investigated the possibility to conduct a non-invasive identification process of liquid samples packed in glass and polypropylene containers. Interdigital capacitor (IDC) structures were designed as solid (build using standard PCB fabrication procedure) and flexible (paper based) structure. Testing was performed using benzene, olive oil, acetone, alcohol, methanol, purified water and formaldehyde. Sample volume and container influence was examined. Information about the sample is available on a 2×16 character and through RS232 connection on

PC. Capacitance measurement and calibration for glass and polypropylene containers and PCB sensor (Figure 3) and testing results are presented (Figure 4).

Fast vaporizable samples were specially considered. For that purpose polypropylene syringes were used with flexible paper-based IDC. With no direct contact between electrodes and liquid samples, there is no electrode deterioration issue, vaporization and also reactive component of the sample is negligible (Figure 5).

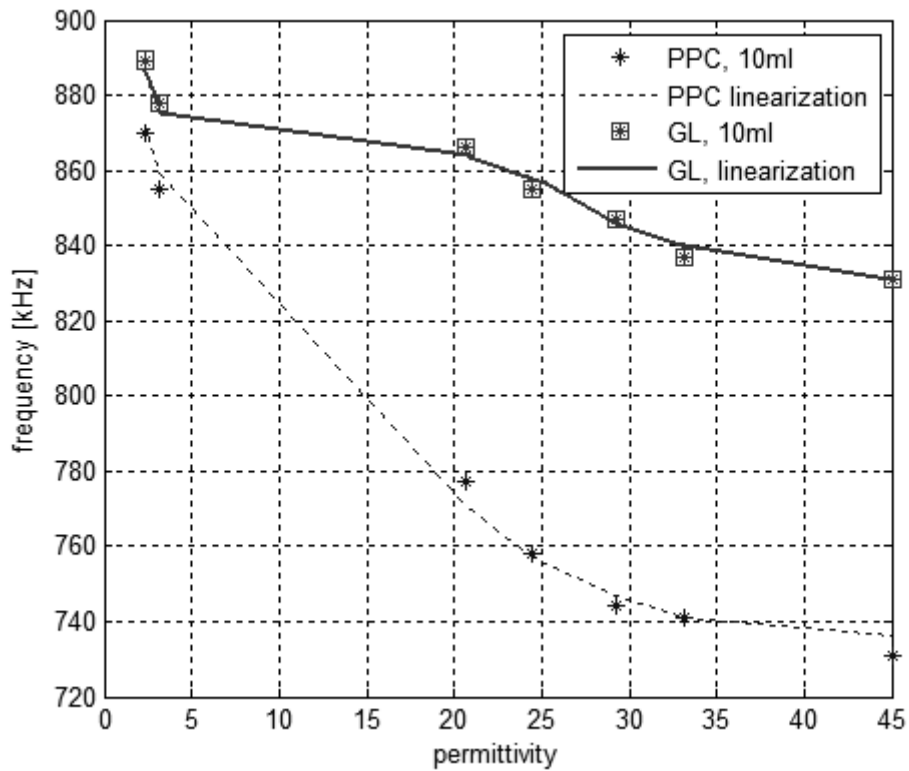

Figure 4: Solid IDC performance in non-invasive approach

Despite these advantages, special care must be taken. Contact surface between PCB IDC and container floor must be smooth in order to achieve maximum performance. Also, glass containers need thicker floors in order to prevent cracks and damaging. This extra thickness affects on electric field penetration height and therefore produces smaller sensitivity.

Paper-based IDC showed promising in possibility to use this flexible structure on container walls, which are thinner and uniform in structure. Major disadvantage of the system is the necessity to take samples into previously determined types of containers and sample volumes. Accurate container positioning is also very important issue.

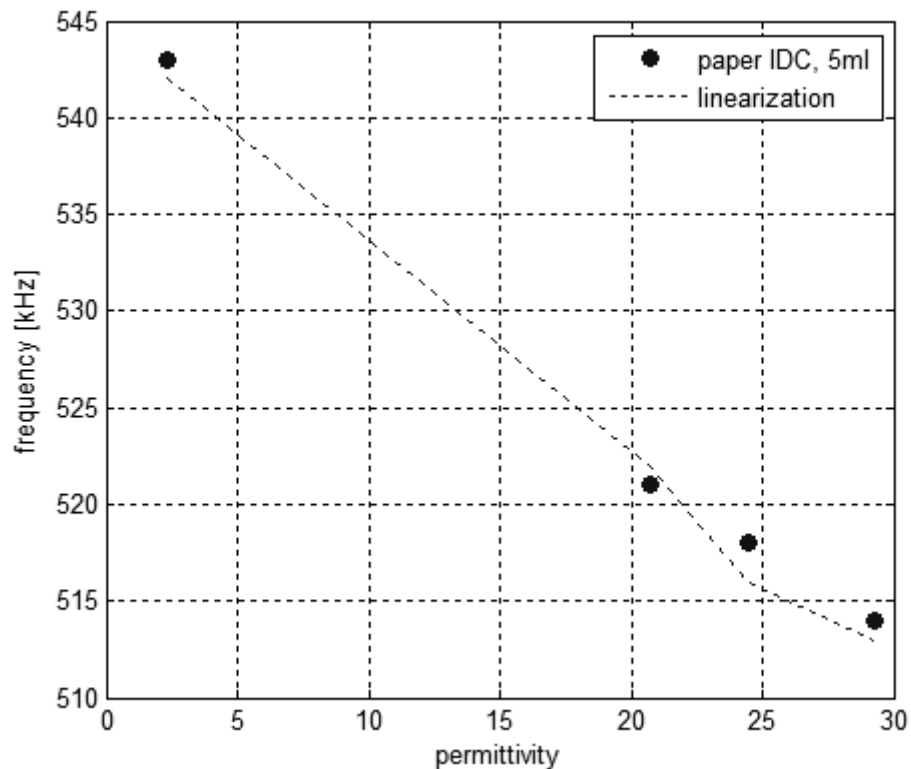

Figure 5: Paper IDC performance in non-invasive approach

The overall uncertainty in sample discrimination with this system has been studied. Experimental results confirm that this approach sufficiently discriminates liquid samples using differences in their permittivity. The non-invasive approach offers a useful tool to study the dielectric property of the liquid samples and a satisfactory performance in discrimination between low numbers of liquids.

Further studies are needed to achieve better resolution and processing in the real life conditions. Design can be improved in sensor geometry by transforming a sensing

element into a single smart “LC tag” for wireless detection purposes. Invasive approach to liquid discrimination assumes samples are pure. Since reactive component can become significant if liquids contaminate with conductive impurities immunization is necessary.

Non-invasive approach can improve by adding automatic container type recognition, as well as volume determination. Further investigations of flexible IDC structures are possible in order to make recognition process available also for pipelined processes. Adding additional interfaces, like GMS modem could be useful for alarming purposes when detecting dangerous substances.

System is open for modification in environmental and water quality monitoring. Foreign compounds create mixtures with water thus affecting permittivity. This change can be used as an early alert for hazards and contamination prevention right on the source. Addition of species selective coatings can improve this system in determining the presence of specific liquids in aqueous mixtures. Further investigation is necessary in order to determine substances which have suitable permittivity and also it is necessary to examine the smallest concentration detectable in this way.

KEY WORDS:

dielectric permittivity; permittivity measurement; interdigital capacitor; non-invasive sensors; frequency shift; microcontroller; RS232;

TABLES LIST

Table 1 Permittivity uncertainties introduced by look-up table bands for solid IDC....	92
Table 2: Permittivity uncertainties introduced by look-up table bands for paper IDC..	93

FIGURES LIST

Fig. 1: Block diagram of instrumental method flow	34
Fig. 2: Basic capacitor configuration	45
Fig. 3: Parallel plate capacitor.....	46
Fig. 4: Parallel plates open up thus providing a planar structure [30]	48
Fig. 5: IDC: a) planar structure, b) cross-sectional view (l – length of the fingers, h – height of the substrate used, t – thickness of the conductive material forming electrodes, ϵ_{sub} – permittivity of substrate, ϵ_x – permittivity of MUT, g – electrode spacing, w – electrode width)	49
Fig. 6: Example of the equivalent circuit for evaluation of the static capacitance of a semi-infinite top layer in a periodic IDC with six electrodes [87]	49
Fig. 7: Conformal transformations for the calculation of C_I . The fixed equipotential lines and their transformations are marked as solid lines while the dielectric and its transformations are the shadowed regions [87]	51
Fig. 8: Conformal transformations for the calculation of C_E . The fixed equipotential lines and their transformations are marked as solid lines while the dielectric and its transformations are the shadowed regions [87]	53
Fig. 9: Conformal transformations for the calculation of C_I for an infinite layer. The fixed equipotential lines and their transformations are marked as solid lines while the dielectric and its transformations are the shadowed regions [87].....	54
Fig. 10: Conformal transformations for the calculation of C_E for an infinite layer. The fixed equipotential lines and their transformations are marked as solid lines while the dielectric and its transformations are the shadowed regions [87].....	55
Fig. 11: Conformal transformations for the calculation of C_I . The boundary conditions are written in figure for the physical plane (x-plane). The dashed line represents a DB condition and the solid line the electrode [88].....	56
Fig. 12: Conformal transformations for the calculation of C_E . The boundary conditions are written in figure for the physical plane (x-plane). The dashed line represents a DB condition and the solid line the electrode [88].....	57
Fig. 13: Equivalent circuits for: a) invasive and b) non-invasive electrode arrangement	59
Fig. 14: Implemented sensors on FR-4 board.....	62
Fig. 15: Cross-section view of IDC sensor with its superimposed layer capacitance configuration	62
Fig. 16: Implemented sensors on paper and FR-2 board respectively	63
Fig. 17: Microcontroller pin-out [118].....	67
Fig. 18: Capacitance voltage divider principle	69
Fig. 19: Ideal capacitor charged with constant current source.....	70
Fig. 20: Non-ideal capacitor charged with constant current source.....	70
Fig. 21: Functional block diagram of TLC555 and pinout [126]	71
Fig. 22: Astable operation of TLC555 timer [126].....	72
Fig. 23: Reverse frequency measurement method.....	74
Fig. 24: Direct frequency measurement method.....	75

Fig. 25: Block model of the system	76
Fig. 26: Example of the 1 st structure placement.....	78
<i>Fig. 27: Flow chart used in microcontroller programming</i>	83
Fig. 28: Flow chart of the system.....	91

GRAPHS LIST

Graph 1: Frequency response of dielectric material [59].....	39
Graph 2: Debye relaxation of water at 30°C [32]	41
Graph 3: Cole-Cole diagram of Graph 2.....	42
Graph 4: Capacitance dependence on the finger width	60
Graph 5: Capacitance dependence on finger gap.....	60
Graph 6: Capacitance dependence on finger number	61
Graph 7: Capacitance dependence on finger length	61
Graph 8: Frequency readings with 1 st structure and 2 nd structure.....	79
Graph 9: Modified frequency used for look-up table with 1st structure and 2nd structure.....	80
Graph 10: Tolerance obtained when 0-999Hz region is removed from frequency	81
Graph 11: Extracted capacitance from modified frequency	81
Graph 12: Fitted capacitance changes obtained from extracted data using 99% confidence bound	82
Graph 13: Modified frequency used for programming.....	84
Graph 14: Extracted capacitance for 8 states	84
Graph 15: Comparison of extracted capacitance against computed fit.....	85
Graph 16: Frequency readings for PPC and GL using solid IDC.....	87
Graph 17: Frequency readings with paper IDC. Liquids used: benzene, acetone, ethanol and purified water	88
Graph 18: Partial linearization for solid IDC.....	89
Graph 19: Partial linearization for paper IDC.....	90
Graph 20: Solid IDC performance	91
Graph 21: Paper IDC performance	92

LIST OF ABBREVIATIONS:

MUT – material under test
IDC – interdigital capacitor
EM – electromagnetic (wave)
RF – radio frequency
TEM – transversal electromagnetic (wave)
LCR meter – inductance-resistance-capacitance meter
PCB – printed circuit board
PPC – polypropylene container
GC – glass container
 μ C – microcontroller
I/O – input/output
PIC – peripheral interface controller
CPU – central processing unit
CMOS – complimentary metal-oxide-semiconductor
dsPIC – PIC controller with integrated digital signal processing
FLASH – electronic non-volatile electronically erasable memory
EEPROM – electronically erasable programmable read-only memory
AC – alternating current
ADC – analog to digital converter
DC – non-alternating current
TTL – transistor-transistor logic
MOS – metal-oxide-semiconductor
RFM – reverse frequency measurement
DFM – direct frequency measurement
TOC – time-based oscillator circuit
UART – universal asynchronous receiver/transmitter
PC – personal computer

1 INTRODUCTION

The objective of development and appliance of methods and instrumentation in any substance analysis, represents obtaining useful information about the material under test (MUT). Analysis includes characterization of the observed sample, as well as an interpretation of the results obtained. Qualitative analysis gives an indication of the identity of the sample's components while quantitative analysis gives the information about the components' amount. Analytical methods are often divided into two groups: classical and instrumental.

Classical ("wet") methods involve various separation methods, such as precipitation, extraction or distillation, as well as qualitative analysis of some physical properties, such as color, odor and melting/boiling point. In quantitative analysis measurements of weight or volume are performed.

Instrumental methods involve machines and instruments in the process of measurement of physical properties such as light absorption, fluorescence or conductivity. Prior separation is achieved using chromatography, electrophoresis or field flow fractional methods.

A general guideline for selecting a suitable approach to the problem is to determine if the MUT is an element or a compound. If it's an element, suitable atomic spectroscopy methods can be used. Compounds can either be pure or mixtures of two or several pure substances. The separation of components in a mixture is usually performed prior to analysis. Composition of a pure substance does not vary. Pure

compounds can be obtained after a single or series of chemical reactions using a purification process.

For example, chromatography collects a set of laboratory techniques in order to separate components of mixture. The mixtures are often dissolved in a *mobile phase* carrier (fluid or gas) and transported over a *stationary phase* structure. Different components travel at different speed which causes separation. When used as a preparative method it only serves for purification. Analytical chromatography determines the relative proportions of compounds in a mixture [1]. Electrophoresis observes the motion of dispersed particles relative to a fluid under the influence of external electric field [2]. Field-flow fractionation represents a separation technique where a field is applied to a fluid suspension or solution pumped through a long and narrow channel, perpendicular to the direction of flow in order to cause separation of the particles based on their mobility under the external field force [3]. Generally, external field is not necessarily electrical in nature.

The ability of material properties measurement became important in variety of applications. The possibility to non-destructively monitor physical or chemical changes in any material (solid or liquid), found its use in industry, medicine as well as science. Purified product can be evaluated by comparing its physical properties with reference standards. Extensive properties, such as mass and volume are very dependent on the amount of sampled substance and are not used in identification process. Intensive physical properties of a substance, such as color, density, freezing point, normal boiling point, solubility and refractive index characterize it as a unique substance, and their determination can often allow one to determine the identity of the unknown [4]-[6].

For low number of samples, it is found that classical "wet" laboratory methods of analysis are most commonly used. For example, the solubility of a substance is usually expressed as the mass of a sample that dissolves in a fixed amount of solvent at a certain temperature. Sodium chloride is an ionic compound and is soluble in a polar solvent. The density is defined as the mass per unit volume and substances with high

densities such as lead or gold are recognized as “heavy in weight”, while others, such as aluminum are “light”. The physical properties discussed above are almost always reported in the literature when new substances are prepared, and are tabulated for previously known substances in the various handbooks of chemical data found in most laboratories and science libraries [7]. If the properties match, identification is assumed. Other gross properties may also be helpful in more thorough identifications.

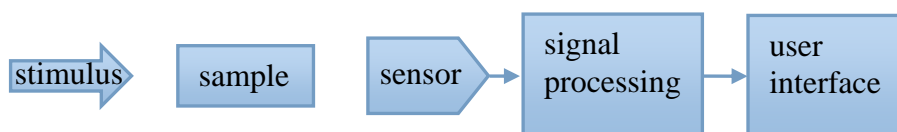

Fig. 1: Block diagram of instrumental method flow

As it can be seen, it is necessary to determine a certain number of properties in order to classify a sample. This process can be time consuming or not suitable for on-field work, as well as dangerous if dealing with toxic substances. Experimental science employed knowledge of vast disciplinary areas and relies on many phenomena providing results through the use of a variety of instruments.

Nowadays, instrumental methods dominate in the obtaining information in diverse areas of science and technology (*Fig. 1*). When compared to classical methods of analysis, these methods give speed, high sensitivity, low limits of detection, simultaneous detection capabilities, and automated operation. In all sciences, important decisions, problem solutions and advances in their fields are based on instrumental measurements. As a consequence, all scientists need to possess a fundamental understanding of instruments and their applications in order to accurately address their needs. A modern, well-educated scientist solves problems with an analytical approach and applies modern instrumentation.

Modern instrumental methods permit the routine analysis and identification of unknown substances. Some of the instrumental approaches [8] are spectroscopy, mass spectrometry, various electrochemical and thermal analyses, and also hybrid techniques

representing combinations of the previous ones [9]. Because of the high cost of precision instruments, laboratory working conditions and due to the cost and time required for maintenance and calibration of such instruments, instrumental methods of analysis are primarily used for repetitive determinations of large number of similar samples, in which case the instrumental method is relatively fast and the cost per analysis affordable.

New approaches tend to be examined and developed. Miniaturization of chemical and biological sensors has received considerable attention in recent years for medical diagnostics, environmental monitoring, pharmaceutical screening and military applications [10]-[16].

The other interesting area of development is dielectric property measuring system from which information such as conductivity and permittivity of MUT is obtained. From the point of view of electromagnetic theory, the electric displacement field response of any substance to a rapidly varying electrical field is defined by a complex dielectric permittivity function ϵ , which is determined by the internal dynamics of the molecules [17]. Dielectric properties of agricultural and food materials can be used for processing applications evaluation, such as heating and drying of granules, meats, vegetables or fruits [18]-[22]. The ability to discriminate between normal and malignant tissue developed many non-invasive techniques for early detection of harmful changes in the human body [23]. In chemistry, dielectric measurements are useful for the characterization of solvents and dielectric analysis of pharmaceutical materials. Identification of liquids is of great importance in security, biology, beverage and food industry as well as environmental monitoring applications.

Most of the sensors used in dielectrometry are capacitive in nature. Capacitive sensors have the advantage of high measurement accuracy and non-invasiveness. The simplest example of a capacitive sensor is a parallel-plate capacitor. More complicated examples include fringing field sensors such as interdigital capacitors [24]-[29].

The detection principle of conductivity and permittivity of MUT is based on capacitive coupling the excitation signal produced by IDC (Inter-Digital Capacitor) electrodes. Frequently used definition for IDC structures states that the interdigital capacitor electrode is a digitlike or fingerlike periodic pattern of parallel in-plane electrode. Periodicity is used to build up the capacitance associated with the electric fields that penetrate into the MUT [30]. The IDC sensor operates in a way that is very similar to a conventional parallel plate capacitor. Depending on the geometric configuration of the electrodes the electric field lines can penetrate deeper with wider electrode configuration. Therefore, the capacitance of the IDC sensor always depends on the dielectric property of MUT and geometry of the electrodes. Typically, a chemically sensitive layer is deposited on top of IDC electrodes in order to detect various gases, chemicals, moisture, organic impurities, etc. When the sensitive layer (usually a polymer) interacts with the chemicals present in the MUT, the layer changes its conductivity (σ), dielectric constant (ϵ), and the effective thickness (h) of the layer. The IDC chemical sensor then detects the change in capacitance due to the change of dielectric constant and the thickness of the layer. The IDC chemical sensors have been investigated by many researchers because they are cheap to manufacture and can be easily integrated with other sensing components and signal processing electronics. These features can be used in order to build miniature, on-field system for simple analysis of low number of unknown samples when high-cost and laboratory equipment isn't affordable.

The motivation for this research is development of a cost-effective sensor which can be integrated in a low-cost, simple system with reasonably fast response and accuracy, with low number and limited amount of sample, suitable for on-field analysis. This thesis aims to achieve the following objectives:

- design and fabrication of the planar electromagnetic sensor based on the interdigital element for the application of liquid discrimination,
- characterization of the sensor and the interface readout circuit,

- development of a low-cost microcontroller based system for liquid recognition.

Chapter 2 describes dielectric properties of a substance and its influences on applied electric field. Basic principles of permittivity measurement are also presented.

Chapter 3 is dedicated to capacitance and dielectrics. Introduction to planar capacitor configuration (interdigital capacitor) has been made and close form equations for capacitance computation provided. Unlike the conventional chemical sensors, IDC used in this thesis was developed as a bare structure, without sensitive coatings. The system has been intended for invasive application, where a direct contact between electrodes and an aqueous sample is expected, as well as for non-invasive application with liquids packed in predefined containers insensitive to samples.

Chapter 4 introduces the basics of liquid discrimination system. Interdigital dielectrometry and description of capacitance measurement principles are given. Suitable approach for microcontroller based application has been explored.

Chapter 5 gives calibration and performance results of invasive approach to liquid discrimination. In this approach a direct contact between solid IDC structures and liquid samples was used. Two configurations were fabricated in order to explore the best performance results.

Chapter 6 introduces non-invasive approach to liquid discrimination. Solid and flexible IDC structures were examined with samples packed into predetermined containers. For solid IDC case, polypropylene and glass cups were used. With flexible IDC configuration a polypropylene syringe was used. Measuring and performance results were obtained and presented.

Chapter 7 gives summary of the thesis work as well as conclusions and possibilities for future development.

Reference section gives a literature list consulted.

2 DIELECTRIC PROPERTIES OF A SUBSTANCE

2.1 Introduction

Propagation of electromagnetic (EM) waves in radio frequency (RF) and microwave systems is described mathematically by Maxwell's equations with corresponding boundary conditions. Dielectric properties of lossless and lossy materials influence EM field distribution. For telecommunication and radar devices, variations of complex dielectric permittivity (referring to the dielectric property) over a wide frequency range are important. For a better understanding of the physical processes associated with various RF and microwave devices, it is necessary to know the dielectric properties of media that interact with EM waves.

Every material has its own dielectric properties. A dielectric material is an electrical insulator that can be polarized by an excitation electric field. Charge carriers shift from their average equilibrium positions causing dielectric polarization thus displacing positive and negative charges in the opposite directions. This process induces an internal electric field to attenuate the external excitation [31]. Several mechanisms can be observed, such as orientation (dipolar) polarization, electronic and atomic polarization as well as space charge polarization. These polarization effects contribute to material's overall permittivity (Graph 1).

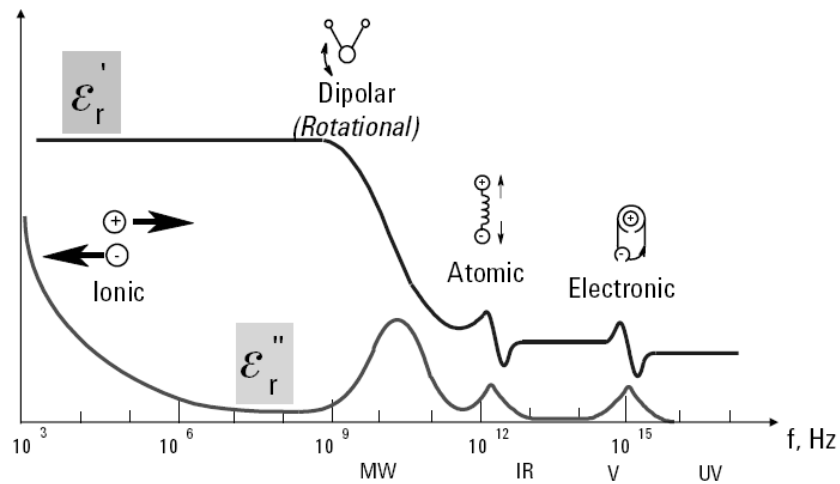

Graph 1: Frequency response of dielectric material [59]

Dipole orientation and ionic conduction interact strongly at microwave frequency. Ionic conduction is caused by migration of free ions and mainly contributes to loss in a material. Dipole moment is created by an imbalance in charge distribution. This moment is affected by an external electric field that causes dipole to rotate in order to align with it. The friction caused by dipole rotation contributes to dielectric losses.

Atomic and electronic mechanisms are relatively weak, and usually constant. Electronic polarization occurs in neutral atoms when an external electric field displaces the nucleus with respect to the electrons surrounding it. Atomic polarization occurs when positive and negative ions “stretch”.

Each mechanism has its characteristic magnitude and “cut-off frequency” (usually in the microwave region) unique for different materials. With the rise in frequency, the slow mechanisms become less important and only the faster one contribute to dielectric constant. The loss factor peaks at each “cut-off” with attributes unique for every material. Resonant effect usually follows electronic or atomic polarization. Relaxation effect accompanies orientation polarization.

This behavior is a unique characteristic for each material and its study represents dielectric spectroscopy [32]. Therefore, a substance can be identified by measuring this single parameter and results compared with reference data. In frequency domain, complex permittivity ϵ is a quantity used to describe interaction of a medium with an external dielectric field. This property represents the influence on reflection of electromagnetic waves at interfaces and the attenuation of wave energy within materials. Equation describing this process can be represented with:

$$\vec{D} = \epsilon \vec{E}. \quad (1)$$

As it can be seen, complex permittivity represents a relation between displacement vector \vec{D} and electric field \vec{E} . Electric field causes atomic/molecule polarization \vec{P} contributing as described by:

$$\vec{D} = \epsilon_0 \vec{E} + \vec{P} = \epsilon_0 \vec{E} + \epsilon_0 \chi_e \vec{E} = \epsilon_0 (1 + \chi_e) \vec{E} = \epsilon_0 \epsilon_r = \epsilon \vec{E}, \quad (2)$$

where $\epsilon_0 = 8.85 \times 10^{-12} \text{ F/m}$, and χ_e represents the electric susceptibility. In complex notation permittivity can be represented as in:

$$\epsilon = \epsilon' - j\epsilon'', \quad (3)$$

where ϵ' represents dielectric constant and energy stored within a material, and ϵ'' is a measure of energy loss. In general, loss consists of two factors represented by:

$$\epsilon'' = \epsilon_d'' + \sigma/\omega, \quad (4)$$

ϵ_d'' is dielectric loss and σ/ω is conductivity loss. When $\sigma/\omega \gg 1$, the material is considered conductor (lossy material). Material is assumed dielectric when $\sigma/\omega \ll 1$.

Material with a single dominant mechanism can be modeled with the Debye relation (Graph 2). Relaxation time τ (a measure of molecule mobility), permittivity ϵ and frequency ω are connected with Debye equation:

$$\frac{\epsilon - \epsilon_\infty}{\epsilon_s - \epsilon_\infty} = \frac{1 - j\omega\tau}{1 - j\omega^2\tau^2}, \quad (5)$$

ϵ_s and ϵ_∞ represent relative permittivity in static and field with an infinite frequency, respectively.

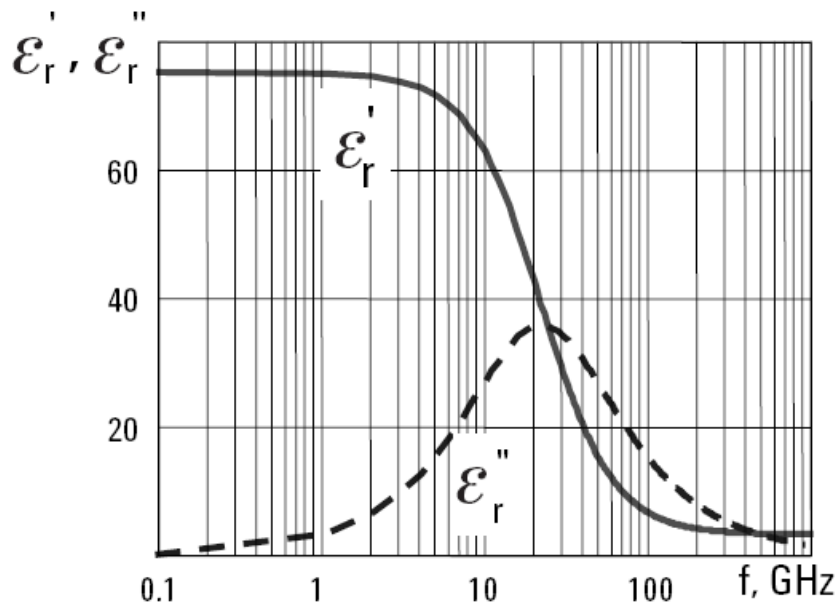

Graph 2: Debye relaxation of water at 30°C [32]

Cole-Cole diagrams also serve to show the imaginary versus the real part of the complex permittivity. A material characterized by the Debye relation appears as a semicircle with its center at $\epsilon_r'' = 0$ and the peak of the loss at $1/\tau$. Graph 3 is a half circle with its center on the x -axis and its radius $\frac{\epsilon_s - \epsilon_\infty}{2}$. The maximal loss represents the radius of the circle. Effects discussed above occur when charges are locally bound in atoms or molecules in liquid as well as solid structures. Interfacial polarization is induced by the prevented migration of free charged carriers. Those charges become

trapped at the material interfaces or they can't be exchanged at the electrodes thus causing the charge accumulation. The field distortion increases the overall capacitance of a material which will manifest as a rise in ϵ_r' .

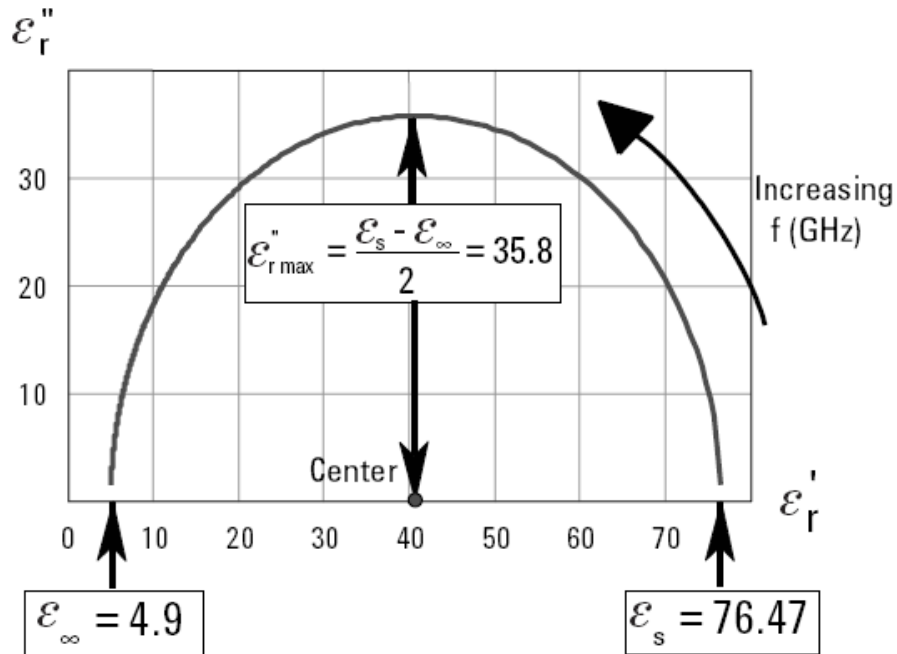

Graph 3: Cole-Cole diagram of Graph 2

2.2 Permittivity measurement

Properties of every material may be determined by standardized tests. Reliable measurements of dielectric properties can provide valuable information for many electronic applications. The loss of a cable insulator, substrate impedance, industrial food, rubber, plastic and ceramics processing as well as density, moisture and concentration, can be related to dielectric properties and used for application improvement. Dielectric properties of materials can be determined with the use of electromagnetic waves (radar/microwave) in the investigations of material and

structural assessment. Basically, there are two different possibilities to perform a dielectric permittivity measurement: low and high frequency methods.

When working with low frequency methods, measurements are conducted in frequency ($10^5 - 10^6$ Hz) or in time domain ($10^{-6} - 10^3$ Hz). Time domain approach uses step change of excitation electric field and time dependent dielectric function can be observed. These techniques usually use voltametric, galvanometric, comparison and zero-equilibrium bridge methods [34], [35].

High-frequency measuring techniques can be divided into resonant and non-resonant. Resonant methods, such as reflection or transmission methods, characterize the material at certain discrete frequency points. These methods suit best for low loss samples [33]. High-frequency non-resonant methods, such as reflection method ($10^6 - 10^{10}$ Hz) and transmission/reflection method ($10^8 - 10^{15}$ Hz), measure permittivity over a broad band of frequencies by measuring characteristic impedance and wave velocity [36].

For example, coaxial probe method is often used for lossy materials at high frequencies. Waveguide requires placement of a sample into the center of the enclosed transmission line. Reflection and transmission coefficient are used. Free space method is non-contacting and non-destructive, used at high frequency. Resonant cavity method is typically used for dielectric measurement of low loss material designed in either transverse magnetic or transverse electric propagation modes. Planar transmission line method is used in RF and microwave components. It requires placement of a dielectric sample over quasi-TEM transmission line, depending on sample's permittivity. The parallel plate method requires placement of a sample within two parallel electrodes. Measurements can be conducted using LCR meter or impedance analyzer along with a dielectric fixture. General descriptions of those methods are provided in the literature [37]-[43]. The measurement results for diverse dielectric media are compiled in the literature [44], [45].

The material characterization is an important issue in many material production, processing, management applications in agriculture, food engineering, medical treatments, and bioengineering. Many of these techniques are equally used for the determination of the dielectric properties of solids as well as liquids. The determination of the dielectric properties of liquids has high practical potential in many industrial, medical, as well as environmental sectors. Liquids are easily manipulated to fit the measurement holder. Also, samples can be shipped (without or with reduced changes in the characteristics), measurements conducted and samples reused again in the process. Generally, the choice of a method must consider the expected permittivity value, required accuracy, material properties, sample size restrictions as well as destructiveness of the sample.

3 CAPACITANCE AND DIELECTRICS

A capacitor is a device which stores electric charge. Capacitors vary in shape (cylindrical, parallel-plate, planar...) but the basic configuration consists of two conductors carrying equal but opposite charges (*Fig. 2*).

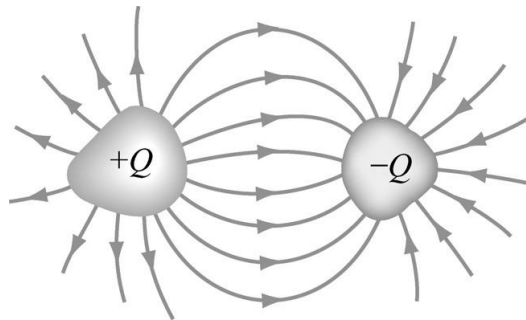

Fig. 2: Basic capacitor configuration

Capacitors have many important roles in electronics, such as storing electric potential energy, delaying voltage changes, filtering unwanted frequency signals, forming resonant circuits, etc.

During the charging process, a charge Q is moved from one conductor to the other one, giving one conductor a charge $+Q$ and the other one $-Q$. A potential difference ΔV is created. The simplest example of a capacitor consists of two conducting plates of area A , which are parallel to each other and separated by a distance d (*Fig. 3*). Real capacitors are finite in size, thus the electric field lines at the edge of the plates are not straight lines. This effect is known as *edge effect* and the non-uniform fields near the edge represent *fringing field*. In parallel plate case this field can be negligible if the $A \gg d$, which is often the case.

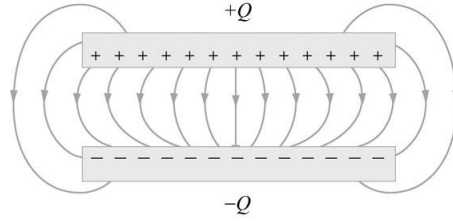

Fig. 3: Parallel plate capacitor

Potential difference between the plates depends on the electric field and the distance between the plates. Capacitance C in the equation (6) represents the influence of geometry and material between plates on the external field:

$$\Delta V = \int_0^d E dx = \frac{Qd}{\epsilon A} = \frac{Q}{C}. \quad (6)$$

3.1 Interdigital capacitor

Historically, the reason for making an interdigital electrode structure is to increase the effective capacitance as reported in design found in the patent of N. Tesla, issued in 1891. [46]. In this example, each “finger” is a rectangular plate, immersed in an insulating liquid. The total capacitance of the “electrical condenser” proposed by Tesla increases approximately linearly with the number of plates. This principle is sometimes used in modern capacitors as well. Theoretical expressions for calculation of capacitance between coplanar strips appeared in the 1920s [47]. Extensive use of interdigital electrodes for sensing applications started in the 1960s along with other forms of coplanar electrode structures [48], [49]. Later, independent dielectrometry studies with single and multiple [50]-[54] penetration depths using interdigital electrodes have continued and found its application in communication, signal processing, chemical sensing, non-destructive evaluation, and biomedical applications.

The applications of these components include lumped elements for microwave integrated circuits, thin-film acoustic-electronic transducers and comb electrodes devices for dielectric characterization of polymers and ceramics materials and gas sensing [55]-[58].

Typical interdigital capacitive sensors (IDC's) are made of an "inert" substrate over which comb electrodes are deposited. Several inherent advantages of the planar interdigital geometry attract device designers. One of the most important ones, especially for these transducers, is that only a single-side access to the test material is required. One can penetrate the sample with electric, magnetic, or acoustic fields from one side of the sample, leaving the other side open to the environment which can allow absorption of gas, moisture, or chemicals, which can change electrical properties of the MUT. Chemically or biologically sensitive layers covering the electrodes can also interact with environment, allowing monitoring of concentration of chemicals in variety of materials as air, transformer oil, or the human body. In some situations, the other side of the material sample may be too far away or inaccessible due to design limitations for an electrode so that one-sided access is essential.

By changing the area of the sensor, the number of fingers, and the spacing between electrodes, the strength of the output signal can be controlled based on the application requirements. In addition to sensing applications, fringing electric fields are used increasingly to generate mechanical forces.

IDC-based sensors have been investigated by many researchers because they are cheap to manufacture and can be easily integrated with other sensing components and signal processing electronics. Properties of the IDCs have been studied by various authors [59] and show high performance when being used as sensors involved with many scientific applications requiring certain features and parameters that achieve the goal of the application. Among other sensor technologies [60]-[65], IDC sensors are well known to be combined with isotropic dielectric materials. Along with species-selective coatings IDCs have been used in numerous applications [66], [67]. Capacitive

changes are used as a factor for monitoring the environments and for measuring the material properties [68]. IDCs are used for the evaluation of conductivity, permeability, and permittivity of materials [69]-[71]; also they have been used for estimation of properties of dielectric material for humidity and gas sensors, biosensor applications and detection of dangerous toxins [72]-[79]. The applications of these sensors depend on both the characteristic of the particular sensor and on the characteristic of the material under test.

3.2 Analysis of IDC's physical model

Beyond the vast usage of IDC sensors, the main problem of these devices lays in the difficulty to obtain components with specific characteristics because of the absence of analytical expressions to predict their electrical response. A useful method for the calculation of the capacitance of IDC structures is conformal mapping technique that provides closed form expressions based on the geometry and properties of the sensor. IDC with an infinite top layer model [80]-[83] is developed and improved [84] to evaluate the capacitance for a sensor having a finite layer structure. Later models were proposed [85], [86] for an IDC with a multilayered top structure based on the same conformal mapping technique. The more general form of multilayered IDC electrodes is developed by Igreja in 2004 [87] and enhanced model was developed in 2011 [88].

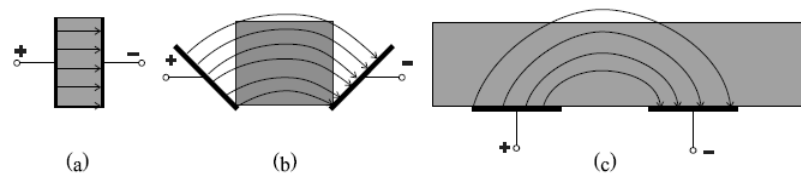

Fig. 4: Parallel plates open up thus providing a planar structure [30]

Compared with parallel plate capacitor structure, IDC electrodes open up thus providing planar structure (Fig. 4). By applying different potential on electrodes electromagnetic field generates in between.

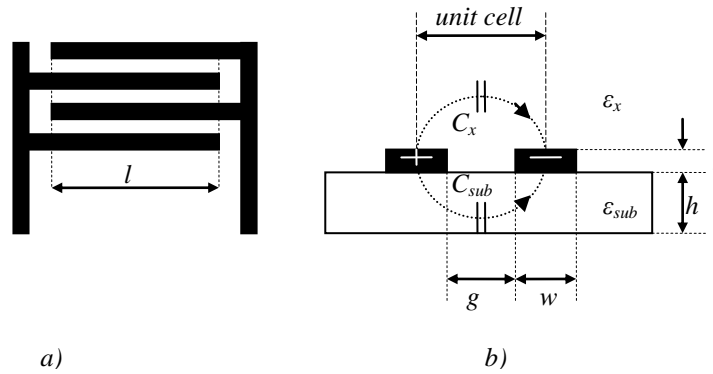

Fig. 5: IDC: a) planar structure, b) cross-sectional view (l – length of the fingers, h – height of the substrate used, t – thickness of the conductive material forming electrodes, ϵ_{sub} – permittivity of substrate, ϵ_x – permittivity of MUT, g – electrode spacing, w – electrode width)

An interdigital capacitive sensor is a coplanar structure consisting of multiple comb electrodes (Fig. 5). Electrode and geometry as well as dielectric properties of material under test (MUT) affect the capacitance and conductance between electrodes.

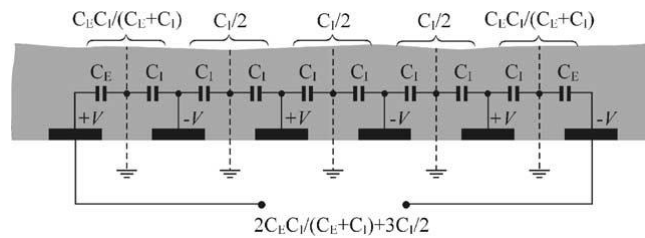

Fig. 6: Example of the equivalent circuit for evaluation of the static capacitance of a semi-infinite top layer in a periodic IDC with six electrodes [87]

As proposed by Igreja (*Fig. 6*), if symmetry is used, C_X and C_{sub} can be obtained by calculation of two unique capacitances: interior half capacitance C_I and exterior half capacitance C_E . These half capacitances represent capacitances between IDC electrode and the dielectric wall positioned in the middle between two electrodes. In solving for the total capacitance of a multi-layered structure it is necessary to model only one half-plane (upper or lower). The other half-plane can be calculated with the same equations. Sum of these results gives the capacitance of IDC.

Each IDC structure consisting of more than one layer, modeling can be divided into two problems: a monotonic decrease in the permittivity from layer to layer as we move away from the electrodes plane ($\varepsilon_1 \geq \varepsilon_2 \cdots \geq \varepsilon_n$), or there is a monotonic increase in the permittivity ($\varepsilon_1 \leq \varepsilon_2 \cdots \leq \varepsilon_n$).

3.2.1 Parallel Partial Capacitance

Total capacitance for structure with monotonic increase in permittivity can be calculated using Parallel Partial Capacitance method. Expressions for C_I and C_E are as reported in [87]:

$$C_I = \sum_{i=1}^{n-1} (\varepsilon_i - \varepsilon_{i+1}) \mathcal{C}_I(h_i) + \varepsilon_n C_I(\infty), \quad (7)$$

$$C_E = \sum_{i=1}^{n-1} (\varepsilon_i - \varepsilon_{i+1}) \mathcal{C}_E(h_i) + \varepsilon_n C_E(\infty). \quad (8)$$

3.2.1.1 Computation of C_I

Fig. 7 represents electrode transformations for calculations of C_I .

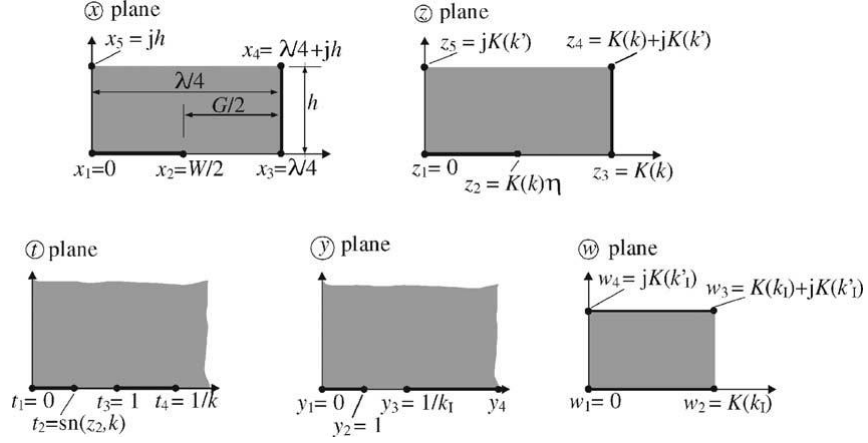

Fig. 7: Conformal transformations for the calculation of C_I . The fixed equipotential lines and their transformations are marked as solid lines while the dielectric and its transformations are the shadowed regions [87]

If we define $r = h/\lambda$, where $\lambda = 2(w + g)$, the modulus k must suffice the following equation:

$$4r = \frac{K(k')}{K(k)}, \quad (9)$$

where $K(k)$ represents the complete elliptic integral of the first kind. Complementary modulus is represented with $k' = \sqrt{1-k^2}$. Modulus k can be calculated as in:

$$k = \left(\frac{v_2(0, q)}{v_3(0, q)} \right)^2, \quad (10)$$

where v_2 and v_3 are the Jacobi theta functions with the nome $q = e^{-4\pi r}$. Equation that maps x -plane into z -plane:

$$z = \frac{4K(k)}{\lambda} x. \quad (11)$$

Rectangle in the z -plane is transformed into the first quadrant in the t -plane by the Jacobi elliptic function of modulus k :

$$t = sn(z, k). \quad (12)$$

Now t -plane must be shifted to the y -plane using:

$$y = \frac{t}{t_2} \sqrt{\frac{t_4^2 - t_2^2}{t_4^2 - t}}. \quad (13)$$

Using Schwartz-Christoffel transformation y -plane transforms into w -plane:

$$w = \int_0^y \frac{dw'}{\sqrt{(1-w'^2)(1-k_I^2 w'^2)}}, \quad (14)$$

where modulus k_I is represented by:

$$k_I = t_2 \sqrt{\frac{t_4^2 - 1}{t_4^2 - t_2^2}}. \quad (15)$$

Using these results it is possible to calculate C_I :

$$C_I = \varepsilon l \frac{K(k_I)}{K'(k_I)}. \quad (16)$$

3.2.1.2 Computation of C_E

For C_E calculation (Fig. 8), the semi-infinite right-hand side strip must be mapped onto the t -plane using:

$$t = \cosh\left(\frac{\pi}{2h} x\right). \quad (17)$$

Mapping into y -plane uses function:

$$y = t \sqrt{\frac{t_4^2 - 1}{t_4^2 - t^2}}. \quad (18)$$

Using Schwarz-Christoffel transformation, y -plane moves to w -plane:

$$w = \int_0^y \frac{dw'}{\sqrt{(1-w'^2)(1-k_E^2 w'^2)}}, \quad (19)$$

where

$$k_E = \frac{1}{t_3} \sqrt{\frac{t_4^2 - t_3^2}{t_4^2 - 1}}. \quad (20)$$

Capacitance in the x -plane can be directly obtained as in:

$$C_E = \varepsilon_0 \varepsilon_r l \frac{K(k_E)}{K(k_E')}. \quad (21)$$

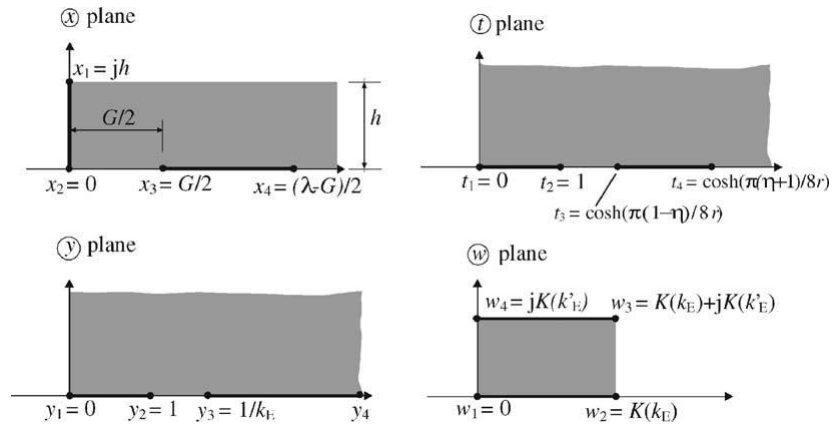

Fig. 8: Conformal transformations for the calculation of C_E . The fixed equipotential lines and their transformations are marked as solid lines while the dielectric and its transformations are the shadowed regions [87]

3.2.1.3 Computation of C_I in the limiting case

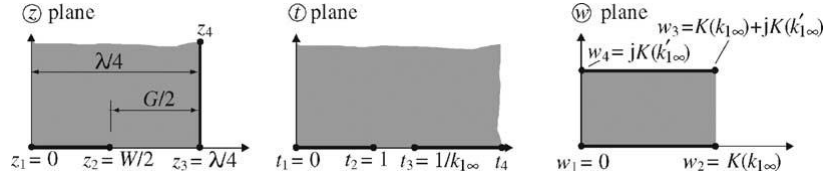

Fig. 9: Conformal transformations for the calculation of C_I for an infinite layer. The fixed equipotential lines and their transformations are marked as solid lines while the dielectric and its transformations are the shadowed regions [87]

For IDCs, it is necessary to evaluate infinite layer thickness (Fig. 9). Modulus changes using following transformations:

$$t = \frac{1}{k_{I\infty}} \sin\left(\frac{2\pi}{\lambda} z\right), \quad (22)$$

and

$$w = \int_0^t \frac{dw'}{\sqrt{(1-w'^2)(1-k_{I\infty}^2 w'^2)}}, \quad (23)$$

leading to:

$$k_{I\infty} = \sin\left(\frac{\pi W}{\lambda}\right). \quad (24)$$

Capacitance expression remains the same as in (16) only the modulus changes.

3.2.1.4 Computation of C_E in the limiting case

For the calculation of C_E (Fig. 10) the transformations used are:

$$t = \frac{2}{G} z, \quad (25)$$

and

$$w = \int_0^t \frac{dw'}{\sqrt{(1-w'^2)(1-k^2w'^2)}}, \quad (26)$$

with,

$$k = \frac{1 - \frac{2w}{\lambda}}{1 + \frac{2w}{\lambda}}. \quad (27)$$

Capacitance expression remains the same as in (21), only the modulus changes into:

$$k_{E\infty} = \frac{2\sqrt{\frac{2w}{\lambda}}}{1 + \frac{2w}{\lambda}}. \quad (28)$$

Total capacitance can be calculated as in:

$$C = (N-3)\frac{C_I}{2} + 2\frac{C_I C_E}{C_I + C_E}. \quad (29)$$

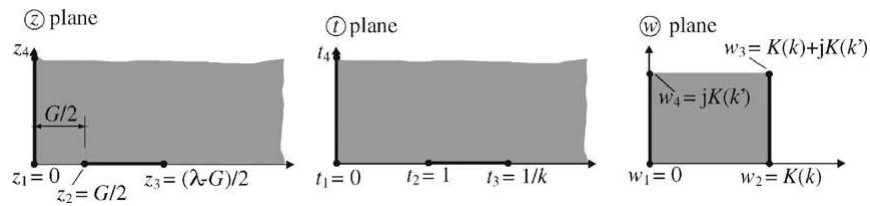

Fig. 10: Conformal transformations for the calculation of C_E for an infinite layer. The fixed equipotential lines and their transformations are marked as solid lines while the dielectric and its transformations are the shadowed regions [87]

3.2.2 Serial Partial Capacitance

Serial Partial Capacitance method is used if there is a monotonic decrease in permittivity. Expressions for C_I and C_E are as follows [88]:

$$\frac{1}{C_I} = \sum_{i=1}^{n-1} \left(\frac{1}{\varepsilon_i} - \frac{1}{\varepsilon_{i+1}} \right) \frac{1}{C_I(h_i)} + \frac{1}{\varepsilon_n} \frac{1}{C_I(\infty)}, \quad (30)$$

$$\frac{1}{C_E} = \sum_{i=1}^{n-1} \left(\frac{1}{\varepsilon_i} - \frac{1}{\varepsilon_{i+1}} \right) \frac{1}{C_E(h_i)} + \frac{1}{\varepsilon_n} \frac{1}{C_E(\infty)}. \quad (31)$$

3.2.2.1 Computation of C_I

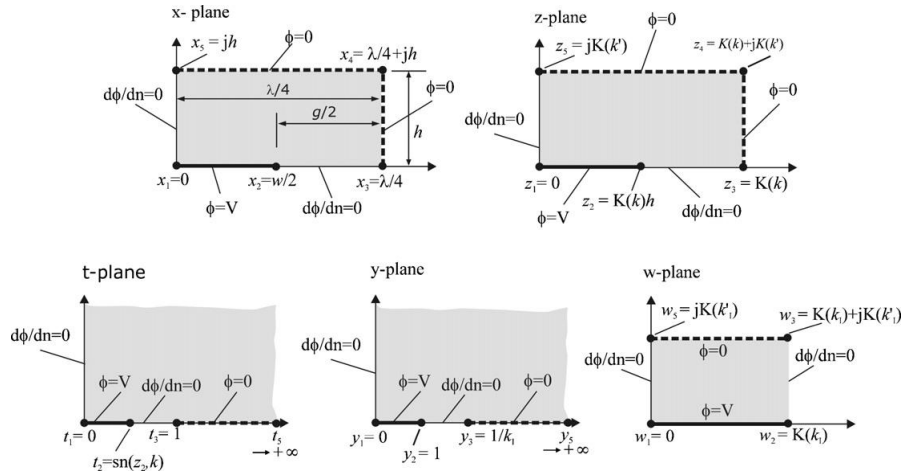

Fig. 11: Conformal transformations for the calculation of C_I . The boundary conditions are written in figure for the physical plane (x-plane). The dashed line represents a DB condition and the solid line the electrode [88]

For this case (Fig. 11) t-plane is mapped on y-plane by the function (32):

$$y = \frac{t}{t_2}. \quad (32)$$

By using Schwarz-Christoffel transformation y-plane is transformed into w-plane using:

$$w = F(\varphi, k_t), \quad (33)$$

with

$$\varphi = \sin^{-1}(y). \quad (34)$$

$F(\varphi, k_t)$ represents the incomplete integral of the first kind with modulus $k_t = t_2$. Capacitance expression remains the same as in (16) only the modulus changes.

3.2.2.2 Computation of C_E

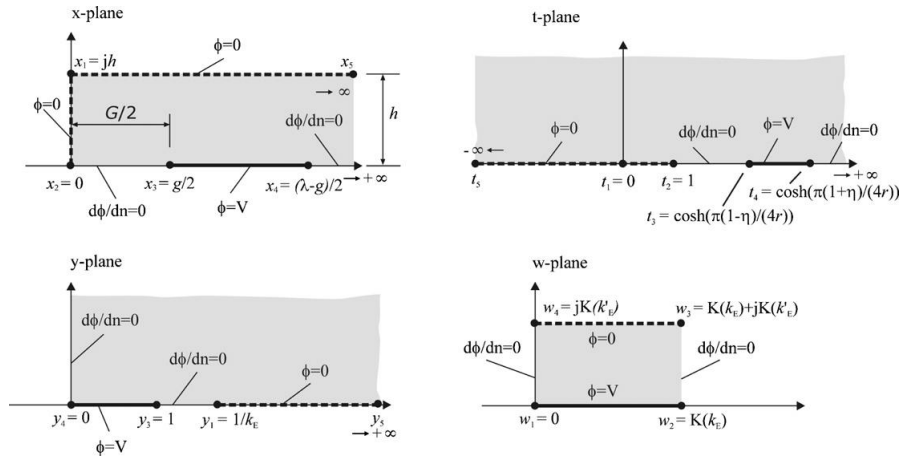

Fig. 12: Conformal transformations for the calculation of C_E . The boundary conditions are written in figure for the physical plane (x -plane). The dashed line represents a DB condition and the solid line the electrode [88]

The semi-infinite strip (Fig. 12) on x -plane is transformed into the t -plane by transformation:

$$t = \cosh\left(\frac{\pi}{h} x\right). \quad (35)$$

This plane is transformed into y -plane by transformation:

$$y = \sqrt{\frac{t_4 - t}{t_4 - t_3}}. \quad (36)$$

Using Schwarz-Christoffel transformation this plane transforms into w -plane by:

$$w = F(\varphi, k_E), \quad (37)$$

with

$$\varphi = \sin^{-1}(y). \quad (38)$$

$F(\varphi, k_E)$ represents the incomplete integral of the first kind with modulus (39):

$$k_E = \sqrt{\frac{t_4 - t_3}{t_4 - 1}}. \quad (39)$$

Expression for C_E remains the same as in (21), only the modulus changes. Capacitances for the infinite layers remain the same as obtained in computations of limiting cases in parallel configuration.

3.3 Design of interdigital capacitor

For the capacitance probe the invasive and non-invasive IDC's can be employed for different measurements, depending on the capacitance electrode configuration of the sensor. Equivalent circuit can be considered for the case of invasive and non-invasive sensors (*Fig. 13*).

Invasive case means that there is a direct contact between the metal electrode and liquid while non-invasive case assumes no contact between the metal electrode and liquid. Present study examines the possibility to conduct the recognition process of liquid samples with both sensor configurations.

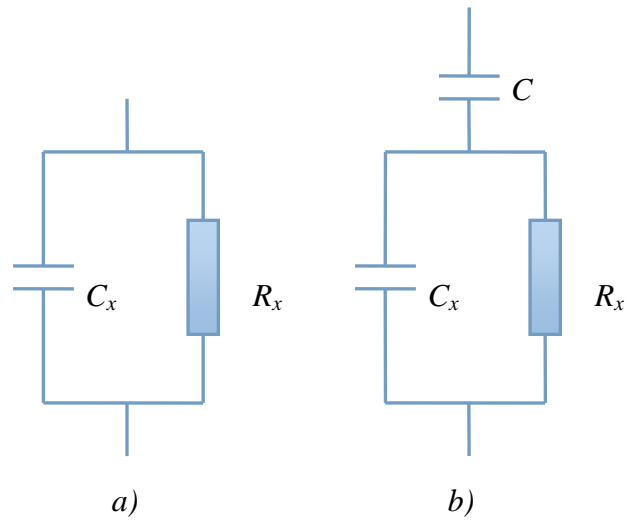

Fig. 13: Equivalent circuits for: a) invasive and b) non-invasive electrode arrangement

Theoretical calculations have been performed, in order to determine the best configuration for sensor structures. Capacitance dependence on geometric parameters such as IDC finger width, gap, length and number has been examined.

Using equations for Parallel Partial Capacitance and necessary integral approximations reported in [59] and [70], capacitance for various geometric parameters of the IDC in order to investigate their influence. FR-4 board was used as an example substrate for IDC modeling. Capacitance dependence on the electrode width is shown on Graph 4. It can be seen that capacitance exhibits strong rise with the increase in the finger width implying serious dependence on this parameter. Capacitance dependence on finger gap is shown on Graph 5.

As it can be seen, capacitance decreases in about 40% with the rise in finger gap from 0.1mm to 1.7mm. Capacitance dependence on the finger number as well as finger length is shown on Graph 6 and Graph 7.

Finger number and finger length affect capacitance in a rather linear manner, where finger number has greater influence on total capacitance.

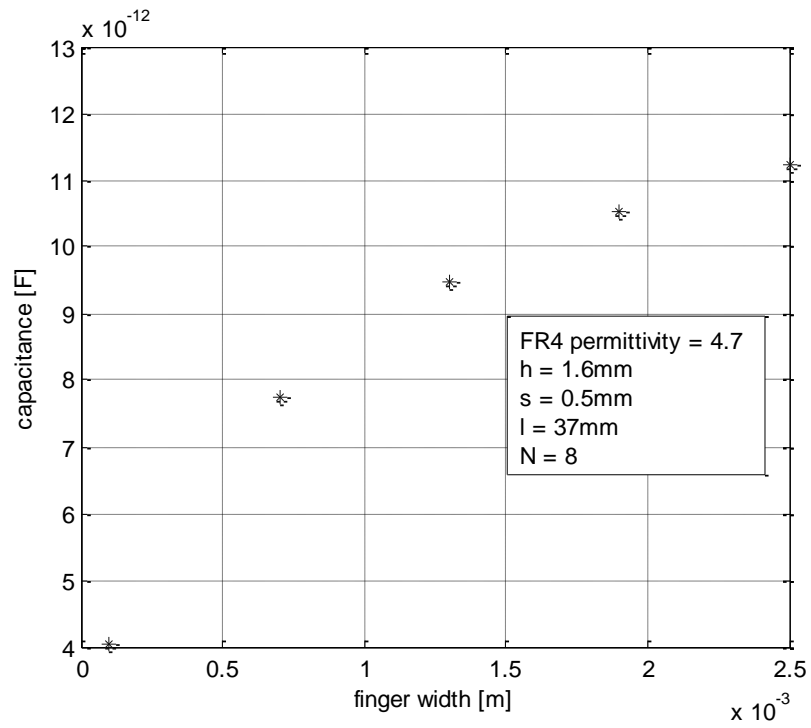

Graph 4: Capacitance dependence on the finger width

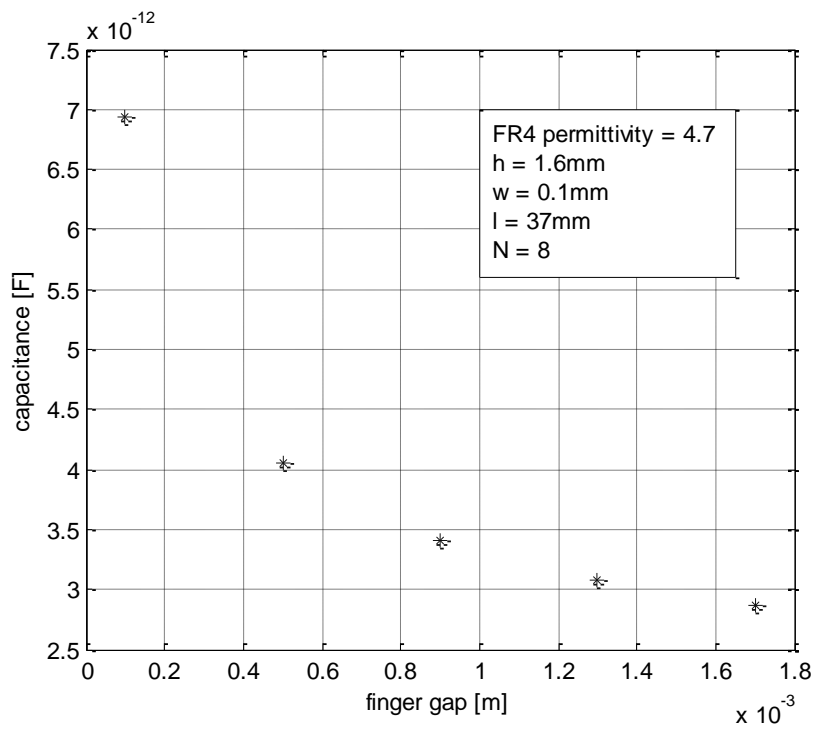

Graph 5: Capacitance dependence on finger gap

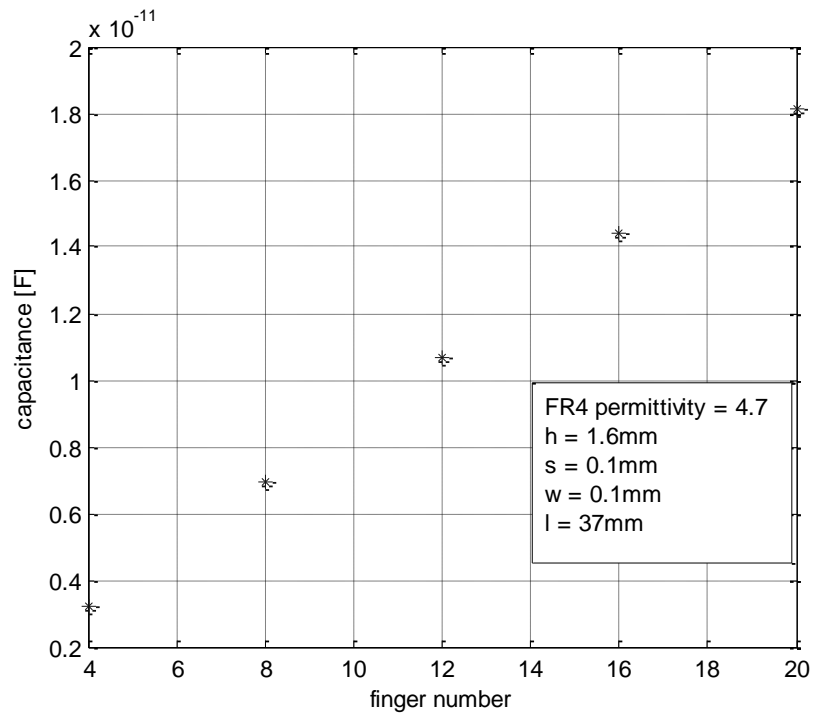

Graph 6: Capacitance dependence on finger number

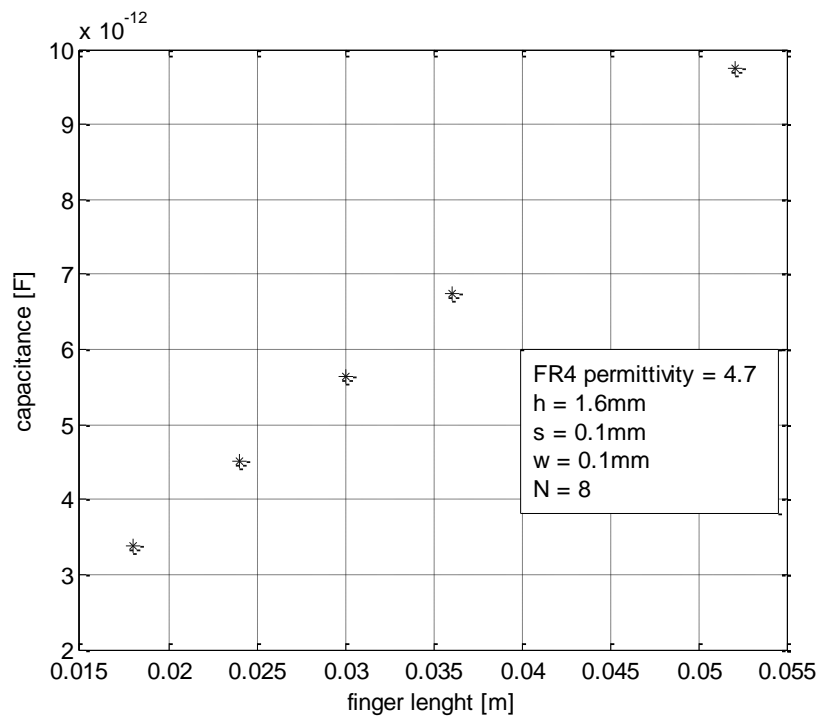

Graph 7: Capacitance dependence on finger length

3.3.1 Invasive method sensor design

Base on previous calculations, two structures of IDCs have been designed and fabricated on a standard FR-4 board using standard procedure for fabricating PCB circuits. 1st structure consists of 8 fingers with finger length 37mm, finger width 0.7mm and finger spacing 0.5mm. 2nd structure consists of 16 fingers with finger length 9.5mm, finger width 0.7mm, finger spacing 0.5mm. *Fig. 14* shows implemented sensors.

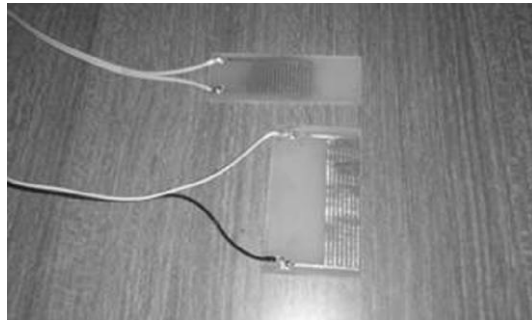

Fig. 14: Implemented sensors on FR-4 board

3.3.2 Non-invasive method sensor design

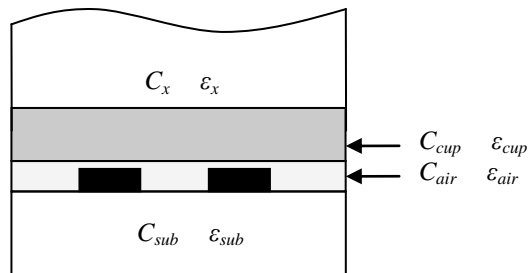

Fig. 15: Cross-section view of IDC sensor with its superimposed layer capacitance configuration

When solid PCB sensor structure is used, container is placed over the electrodes through its full floor surface. As it can be seen (*Fig. 15*), there are three layers above the electrodes: air (in sub-mm height due to non-ideal contact between electrodes and the container), container floor (with substantial thickness) and a liquid sample [89].

Electromagnetic field lines must penetrate through air, the container and sufficiently into the MUT. Maximum electric field penetration height occurs at about half the sensor wavelength. This means that the sensor is not sensitive to a distance from the electrode plane greater than $w + g$. Containers prepared for sample packing were polypropylene (PPC) and glass (GC) containers. PPC has 55mm in diameter, approximately 0.5mm floor thickness. GC has 55mm in diameter, approximately 3mm floor thickness. Based on this dimensions, $w + g$ must be greater than 0.5mm in order to penetrate PPC container floor, and greater than 3mm when used for GC. Solid PCB IDC's structure was fabricated using standard PCB fabricating procedure. Structure on FR-2 board, consists of seven fingers with $l = 37.5\text{mm}$, $w = 4\text{mm}$, $g = 0.5\text{mm}$.

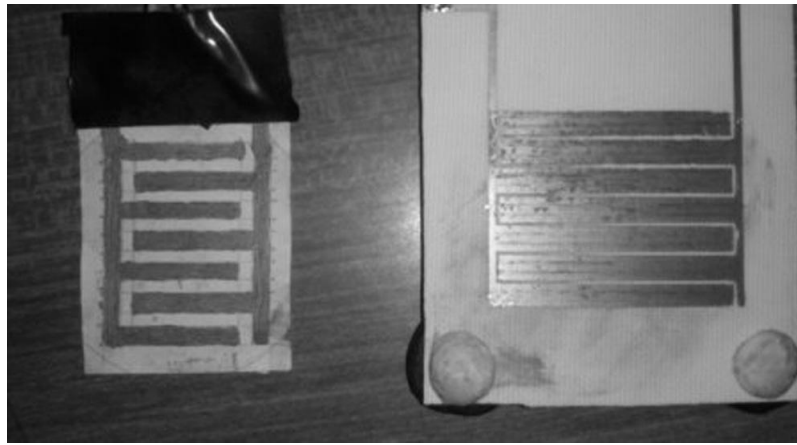

Fig. 16: Implemented sensors on paper and FR-2 board respectively

During experiments in our work using invasive approach [90] it was established that some of the fast vaporizable samples (such as benzene, acetone and ethanol) deteriorate, if measurement process lasts. This can cause degradation in sensor readings. In order to avoid this, standard 5ml polypropylene syringes were prepared for these samples with flexible paper based IDC structure to be taped around. Syringes

have 10mm in diameter, with 1mm wall thickness. Paper IDC needs $w + g$ greater than 1mm in order to penetrate into the MUT. Flexible paper-based IDC structure [91] consisting of seven fingers with $l = 28\text{mm}$, $w = 3\text{mm}$, $g = 2\text{mm}$ was fabricated on regular blank piece of paper with traces drawn using nickel conductive emulsion provided from CircuitWorks. Traces drawn in this way have μm thickness fully conductive in air cure reached in 45min. Fabricated sensors are reported in *Fig. 16*.

4 LIQUID RECOGNITION SYSTEM DEVELOPMENT

4.1 Interdigital dielectrometry

Dielectrometry represents very important method for material characterization. Using this approach, it is possible to extract dielectric properties of a MUT by measuring capacitance of a sensor. By varying geometry, materials, manufacturing process as well as read-out circuits, improvement can be achieved. Most of the sensors used in dielectrometry are capacitive in nature. These sensors have the advantage of high measurement accuracy. The simplest example of a capacitive sensor is a parallel-plate capacitor. More complicated sensors employ fringing fields assuming variety of geometries such as cylindrical geometry to measure the permittivity of a dielectric plate [92]. Also, rectangular coplanar capacitance sensor has been employed for water intrusion monitoring [93] as well as damage detection in laminated composites [94].

Electrical capacitance tomography is another capacitance measurement technique that is used to image cross-sections of industrial processes containing dielectric materials [95]. Over the past decades, research progress on both the hardware design [96], [97] and sensor configuration optimization [98] has been made. Since the changes in the dielectric properties are usually induced by changes in various physical, chemical, or structural properties of materials, the dielectrometry measurements provide effective means for indirect non-destructive evaluation of vital parameters in a

variety of industrial and scientific applications such as agricultural products [99], food products, paper, transformer board [100], and hydrophilic polymers [101].

Interdigital dielectrometry is a subset of interdigital electrode sensor applications that relies on direct measurement of dielectric properties of insulating and semi-insulating materials from one side [102]-[106]. A relatively new field of research is an interdigital frequency-wavelength dielectrometry, a close relative of electrical impedance tomography. The depth of penetration of quasi-static electric field lines into the material is frequency independent and proportional to the sum of finger width and gap between fingers. The differing penetration depths of multiple wavelengths make possible spatial profiling of dielectric and conduction properties of individual layers across the thickness of a medium without direct access to each layer and therefore making their usage more flexible than other geometries. The response of the electrode structure with the shortest wavelength will reflect the dielectric properties of the material directly above electrodes, while further rise in spatial wavelength will increase in the influence of the structure deeper into the material. Overviews of important concepts related to this technology are available in [107]-[116].

4.2 Microcontroller dsPIC30f4013

The material evaluation systems combine precise instruments, test fixtures and software for sample parameter calculations. Specific manufactures provide a variety of fixtures and measurement instruments covering many sample types. Along with interface software, depending on required measurement techniques and instruments, such systems are usually integrated as kits [117]. Solutions are fast, accurate, with numerous methods available to suit the application need. Major disadvantage of these kits is their cost and often the necessity of lab environment in order to achieve best performance results.

A microcontroller (μC) is a single integrated circuit consisting of a processor, memory and programmable I/O peripherals. Nowadays, microcontrollers are widely used as a useful tool for measuring various physical properties with minimum additional interface circuitry, making entire systems low-cost, compact and suitable for on-field work. Numerous applications, such as day life devices (light and temperature sensing and control as well as fire detection) and also industrial instrumentation and process control, employ microcontrollers. Measurement techniques applied, can be numerous for different variable types and often strongly depend on the characteristics of the measurement.

The main reason for microcontrollers' vast usage lies in cost advantages. μC is generally build as a device that uses less power and it's suitable for battery-powered applications. The architecture of a typical microcontroller often includes a central processing unit (from 4-bit architecture up to 64-bit processors), memory modules, data bus, a clock generator, programming capabilities, analog to digital converters, timers, counters, serial ports [118].

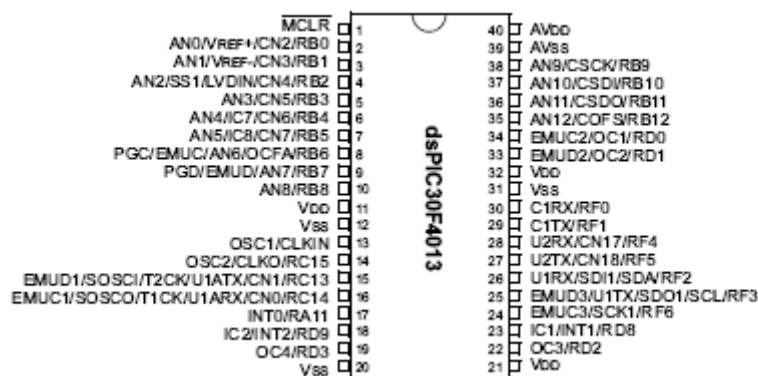

Fig. 17: Microcontroller pin-out [118]

PIC family of microcontrollers employs modified Harvard architecture microcontrollers made by Microchip Technology. dsPIC devices include digital signal processing capabilities as well.

Microcontroller dsPIC30f4013 (*Fig. 17*) represents integration of the central processing unit (CPU), memory as well as peripherals and does not requests a complicated external hardware in order to build a system. This microcontroller is made in CMOS technology and requires 5V of stable power supply. dsPIC family consists of build in FLASH and EEPROM memory for data and memory storage as well as support for a large number of input/output devices. For the purpose of this thesis, the entire system is build around this microcontroller.

4.3 Capacitance measurement

For the capacitance measuring, different techniques such as LCR, AC bridges, charge/discharge, relaxation, oscillation and resonance as well as capacitance to phase, capacitance to voltage, switched capacitor and analog to digital conversion methods are used in different applications [119]-[123].

Low value capacitive sensors require instrumentation capable of measuring pF range capacitances with high sensitivity. Stray and lead capacitances are often comparable with the sensor itself. Drift and offset error, frequency range as well as cost must be considered when developing a read out circuit.

There are several approaches suited for capacitance measurement using microcontrollers and minimal external hardware. Depending on devices capabilities some of the methods used, can be divided into groups, such as:

- charge transfer,
- resistor-capacitor charge timing,
- relaxation oscillator.

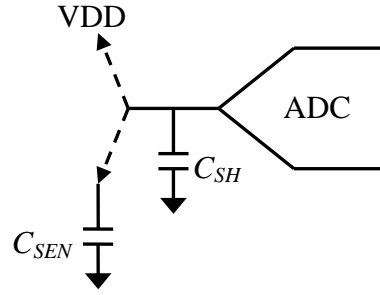

Fig. 18: Capacitance voltage divider principle

Charge transfer method (Fig. 18) uses charge transfer from a reference capacitor onto a sensor during certain number of cycles. The voltage change on the capacitors decreases exponentially. This approach employs analog to digital converter (ADC) to measure capacitance. The internal sample and hold capacitance (C_{SH}) of the ADC is used as a reference for calculating external capacitance. One ADC channel is used to fill (C_{SH}) up to supply voltage V_{DD} . This channel is then connected to sensor creating a parallel connection between internal ADC capacitance and the sensor. Second ADC channel samples the voltage providing the amount of capacitance on the sensor.

Charge time measurement method applies constant current source to the capacitive sensor thus creating a DC voltage across a capacitor. An ideal capacitor charged in this way creates a ramp:

$$I \times T = C \times V. \quad (40)$$

I represents the constant current source, T is the fixed charging period measured using timers, C is the sensor capacitance and V is sensor voltage that can be read by an ADC.

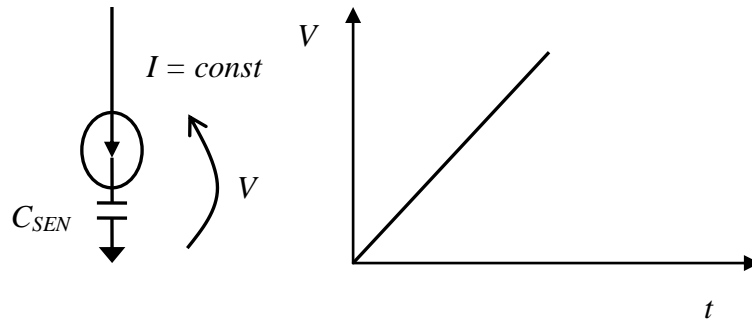

Fig. 19: Ideal capacitor charged with constant current source

Capacitance can be calculated by observing the rate of change in capacitor voltage if a capacitor is ideal. Non-ideal capacitors exhibit dielectric absorption, leakage, dissipation factor and equivalent series resistance. In order to include these losses, capacitor is often modeled as a capacitor with resistor in parallel. The charging and discharging of such a capacitor take place exponentially and depend on capacitance as well as resistance:

$$v(t) = IR(1 - e^{-t/\tau}). \quad (41)$$

This transcendental equation can only be solved using iterative techniques, but the derivative of this equation can be expressed in a closed-form:

$$\frac{dv}{dt} = \frac{I}{C}(e^{-t/\tau}). \quad (42)$$

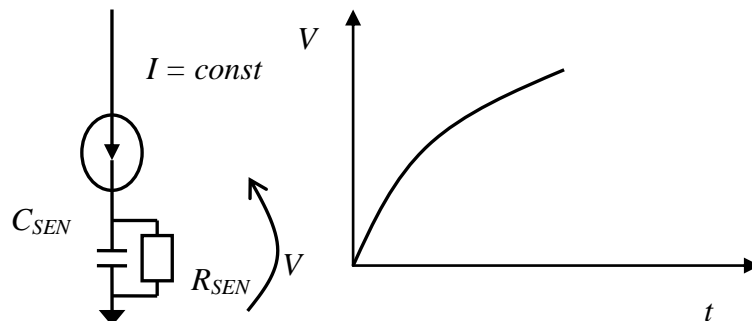

Fig. 20: Non-ideal capacitor charged with constant current source

An exponential fit must be performed on ADC readings and τ calculated. After this, the equation (42) can be used to calculate C . This approach requires very fast ADC sampling without significant noise, current source must be ideal as much as possible and the internal ADC capacitance must have high Q -factor to prevent error due to its own time constant.

Relaxation/oscillation based method is usually used with microcontrollers. This approach requires an external RC or LC oscillator circuit producing periodic waveforms such as square, triangular, sawtooth or sinusoidal. In order to build the oscillator, sensor capacitor is charged to a certain upper threshold and discharged to lower threshold voltage. Capacitive changes are detectable through changes in oscillation frequency, inversely proportional to capacitance changes. Periodical pulses can be converted into voltage or directly processed by a microcontroller. Pulses must be in 0-5V range, since microcontroller operates on a single power supply.

4.3.1 Capacitance to frequency conversion

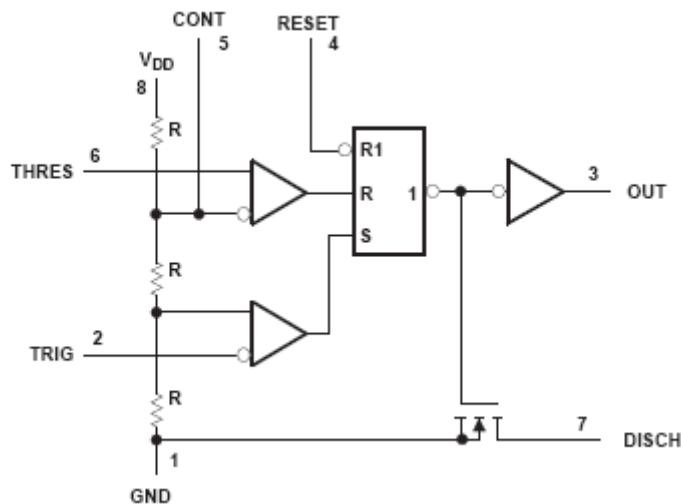

Fig. 21: Functional block diagram of TLC555 and pinout [126]

When it comes to small capacitances changes, as described in various papers [124], [125] sensor capacitance is often first converted to a frequency using a free

running multivibrator circuit. This approach is suitable for small capacitors, such as ours, since small changes in capacitance induce relatively large frequency shifts.

For the purpose of this work a timer TLC555 [126] is used. This timer represents CMOS version of a standard NE555 timer and is fully compatible with CMOS, TTL and MOS logic and operates at frequencies up to 2 MHz. TLC555 is an example of an *interface* integrated circuit consisting of both analog and digital circuitry (Fig. 21). Because of its high input impedance, smaller timing capacitors can be used. An *RS flip-flop* controls *output* and *discharge* pins. The separate *reset* terminal overrides any other command and *clears* the flip-flop. *Discharge* terminal is connected via transistor to the ground terminal and used for discharging capacitor. Flip-flop inputs are supplied by two comparators monitoring analog voltages on the *trigger* and *threshold* inputs. Comparator reference voltages for these inputs are $0.67V_{DD}$ and $0.33V_{DD}$.

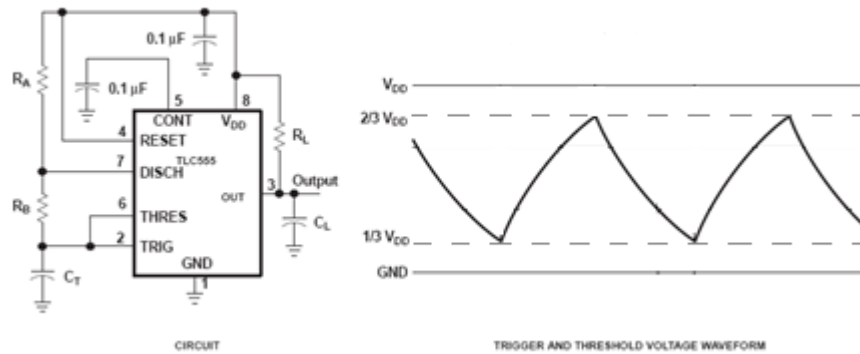

Fig. 22: Astable operation of TLC555 timer [126]

When TRIG and THRES are shorted, TLC555 runs as an astable multivibrator (Fig. 22). Capacitance charges through R_A and R_B to the threshold voltage $0.67V_{DD}$. This sets the internal flip-flop and capacitor starts to discharge through R_B . When capacitor voltage goes below trigger level $0.33V_{DD}$ process repeats with capacitor charging. The output is high during capacitor charging (43) and low during discharge (44).

$$t_{c_high} = C_T(R_A + R_B)\ln 2, \quad (43)$$

$$t_{c_low} = C_T R_B \ln 2. \quad (44)$$

Using equations (43) and (44), TLC555 output frequency f can be calculated with:

$$f = \frac{1.44}{(R_A + 2R_B)C_T}. \quad (45)$$

4.4 Frequency measurement methods

Mostly used methods for frequency measurements used are the reverse frequency measuring (RFM) and the direct frequency measuring (DFM). In both methods, a time-base oscillator circuit (TOC) is required. TOC represents a pulse oscillator with a high stability and precision. The frequency of this circuit determines different parameters of the measuring results, depending of the method chosen.

4.4.1 Reverse frequency measuring

This method is mainly used for low frequency measurement (*Fig. 23*). For this method TOC is chosen with very high frequency. By measuring the period instead of the frequency, it is possible to decrease the error without increasing the duration of the measurement. The basic principle is to measure how many TOC pulses can be count during one period of the input signal. In order to calculate the frequency, it is necessary to divide the TOC frequency by the pulses counted:

$$F = \frac{TOC_frequency}{pulses_counted}. \quad (46)$$

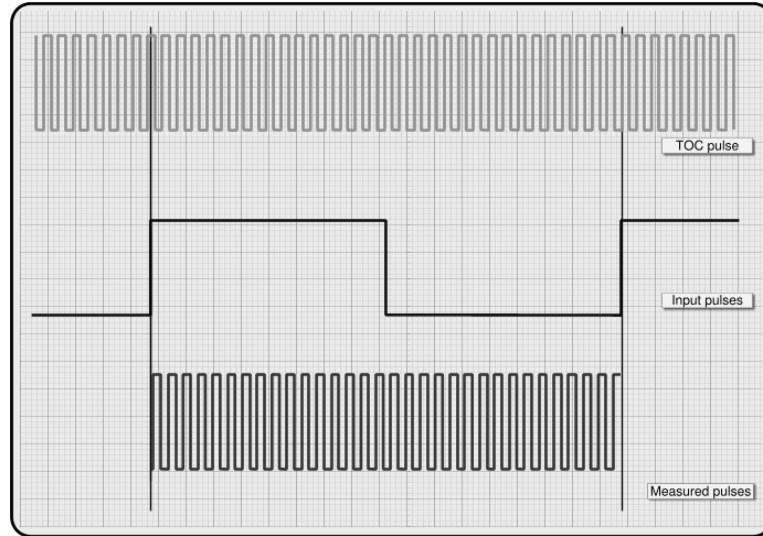

Fig. 23: Reverse frequency measurement method

This method usually requires a microcontroller to mathematically deal with data. The accuracy of this method can be increased if TOC pulses are counted over several periods of input signal. Total frequency is calculated as in previous case but multiplied with n number of periods:

$$F = n \times \frac{TOC_frequency}{pulses_counted} . \quad (47)$$

The measuring error for this method is inversely proportional of the TOC frequency. Unlike direct frequency measuring this method can measure the frequency of the each pulse separately.

4.4.2 Direct frequency measuring

This is basically the most straight-forward method of frequency measuring (*Fig. 24*). The TOC oscillates at rather low frequency determining the sampling rate of the circuit. For example, if TOC oscillates at 1Hz, sampling provided is once per second.

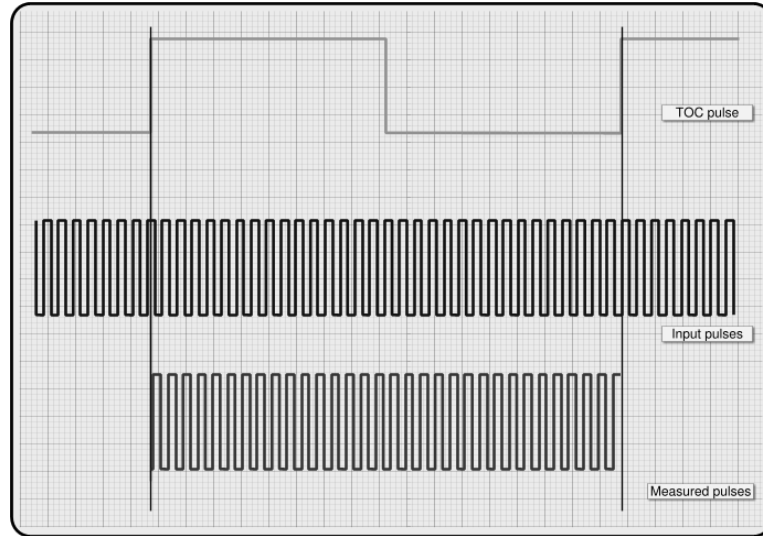

Fig. 24: Direct frequency measurement method

During a complete period of TOC, the signal pulses are measured. Used in this way, the counting determines the number of the whole cycles M occurring during a time interval T given by the TOC:

$$F = \frac{M}{T} . \quad (48)$$

The advantage of this method is that with properly selected TOC, frequency can be measured with no mathematics used. For example if a TOC period is 1Hz than pulse count represents frequency in Hz.

The measuring error of this method increases with the decrease of the input frequency. This method only counts pulses, thus only returning integer value of the pulse count. For example, frequencies 100Hz as well as 100,9Hz will be counted as 100Hz. Improvement in accuracy demands reducing the sample rate, making measurement rather time consuming. That is why this method is used mainly for high frequency measurement, because the accuracy is reverse proportional to the frequency of the TOC, while the sampling rate is equal to the TOC frequency. Another characteristic of this method is that, during measurement cycle, if a frequency is changed, the result measurement will be the average of the frequency.

5 INVASIVE RECOGNITION MECHANISM

As previously discussed, when using an invasive configuration, there exists a direct contact between MUT and capacitor electrodes.

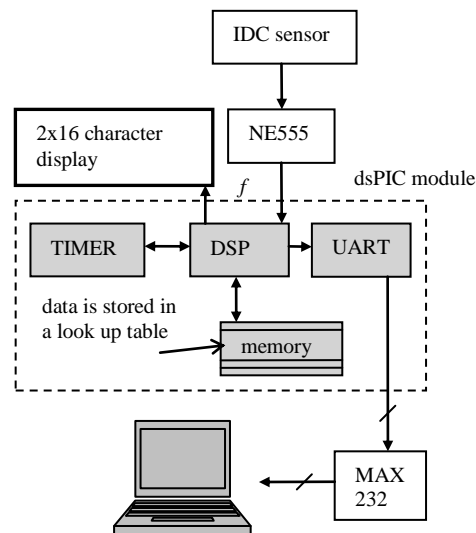

Fig. 25: Block model of the system

Block model of implemented unit is presented on *Fig. 25* while electric schematic is provided in Appendix 1. Main circuitry was built on FR-4 board with IDC sensor available for soldering onto connection points through 10cm long wires for easier manipulation. UART enables communication between the microcontroller and other devices using RS232 standard. PC connection requires voltage levels for logic 1 between +3V and +12V. Logic 0 is represented between -3V and -12V. Because of this

additional circuit MAX232 is needed in order to adjust voltage levels between microcontroller and other devices. MAX232 is basically transmitter/receiver circuit used for voltage level conversions from 0V to 5V into +/-12V and vice versa. Information is also available on 2×16 character LCD.

Liquids used for testing were: benzene $\epsilon_r = 2.3$, phenol $\epsilon_r = 4.6$, acetone $\epsilon_r = 20$, ethanol $\epsilon_r = 23.4$, methanol $\epsilon_r = 33.1$, formaldehyde $\epsilon_r = 45$ and distilled water $\epsilon_r = 78$; plus a ready state when sensor detects only air $\epsilon_r = 1$.

As previously discussed in Chapter 3 sample capacitances consist of dielectric C_x and loss term R_x (resistance in parallel). Generally, pure substances have a low loss term [127]-[128]. As reported in [129]-[132], in the invasive approach the additional care is requested, because the effect of R_x can be negligible only if the ON resistance of the charge switch is small compared with R_x , and if the discharge time, which is determined by the switching on time of the resistance of the discharging switch, is short compared to the time constant given by $R_x \cdot C_x$.

As described in Chapter 4 in timer basics there is charging and discharging of a sensing capacitor C_T through two resistances, thus setting up the frequency of an output. Charging goes through $(R_A + R_B)$, and discharging through R_B . Resistors in timer circuit were chosen in kilo ohm region so it can be assumed that R_x in sensor model can be omitted. Timer resistor values are $R_A = 10 \text{ k}\Omega$ and $R_B = 100 \text{ k}\Omega$.

Microcontroller dsPIC30f4013 is used to perform readings and necessary conversions. Necessary programming was performed in micro C. Rubber container, approximately 4cm in diameter, 2mm in height as well as IDC sensors were properly wiped clean using acetone and cotton wool. Calibration process, as well as further testing, was conducted with liquids in room temperature (23°C).

5.1 Microcontroller programming and calibration

Calibration points were water, acetone, and air. Chosen liquid (approximately 10ml volume) was poured in a container. As discussed in Chapter 3, two structures were fabricated for invasive approach examination. Calibration started by putting the 1st structure on top of a container so that its full surface can touch the surface of a liquid (Fig. 26).

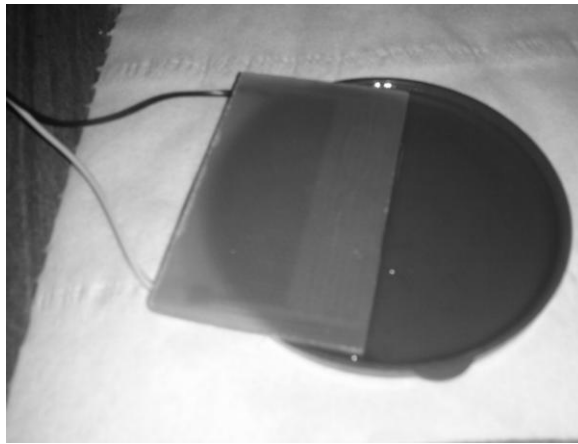
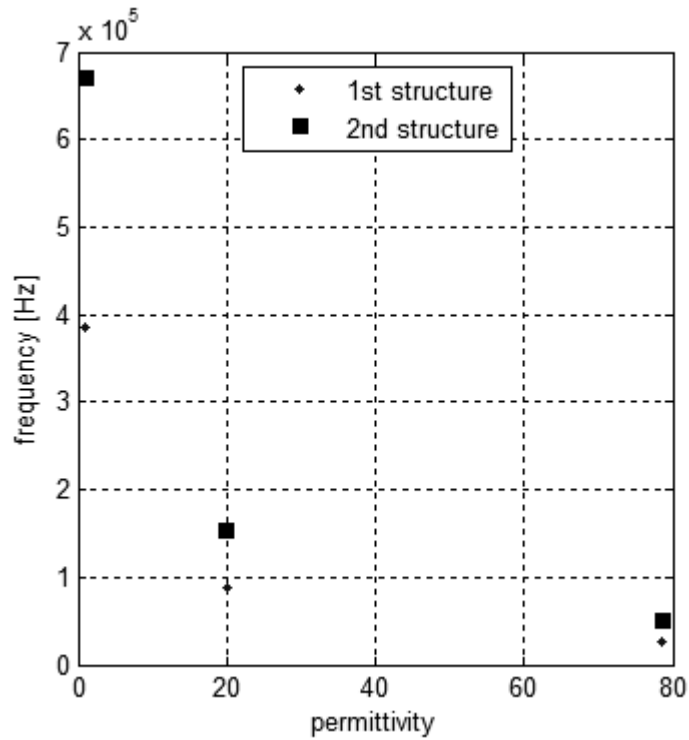

Fig. 26: Example of the 1st structure placement

Since sensor capacitance is relatively small, frequency produced by TLC555 is high enough for direct measuring method to be used. dsPIC is set to generate 1s time window during which it counts pulses from TLC555 and prints the result on a display. Timer unit, build in dsPIC, is used for the time measurements. Timer represents a counter bock counting time rise in equal intervals. By taking the counter number in certain points of time it is possible to get the information about the time elapsed. When readings stabilize (based on multiple tryouts it takes no more than 5s) printed value is recorded. Sample can be removed from a container and along with IDC properly cleaned using cotton wool and acetone. Process has been repeated ten times for each liquid. 2nd structure can be examined and entire process repeated using benzene for cleaning instead of acetone.



Graph 8: Frequency readings with 1st structure and 2nd structure

Graph 8 represents averaged data obtained from microcontroller readings in calibration points used in this experiment. Readings showed no major improvement when benzene was used for cleaning, except that sensors dried symbolically faster. Acetone and benzene were chosen for cleaning particularly because they vaporize fast.

During frequency measurement it was established that reliable difference between liquids occurs in kHz region. In further programming frequency was rounded in kHz format. Solid digits are used for recognition process (Graph 9). Using this approach region 000-999Hz was removed from area of interest. This assures stability and reproducibility but some tolerance has been made. Relative tolerance can be calculated as in:

$$tolerance = \left| \frac{y_{\max} - y_{reduced}}{y_{\max}} \right| \times 100, \quad (49)$$

where y_{max} represents measured frequency if all the omitted digits are assumed maximal, and $y_{reduced}$ represents frequency after omitting the Hz region.

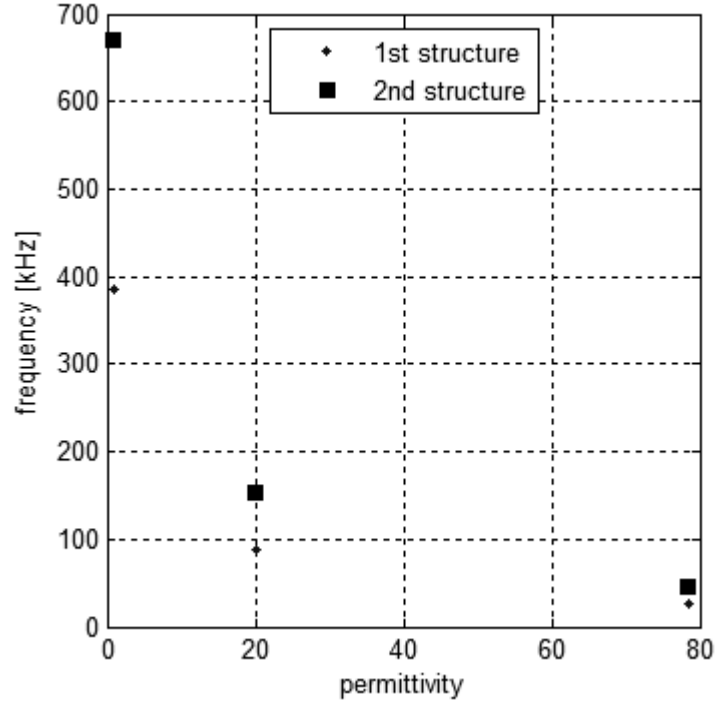

Graph 9: Modified frequency used for look-up table with 1st structure and 2nd structure

When using 1st structure this represents around 0.3-0.4% tolerance in frequency measurement, while with 2nd structure this represents 0.1-2% tolerance (Graph 10).

2nd structure also exhibits larger frequency separation between liquids used. Graph 11 shows extracted capacitance for both structures obtained using Eq. (45).

Theoretically obtained air-capacitance value for 1st equals 8pF, while for 2nd structure equals 4.3pF. Extracted capacitance from measured frequency for 1st structure equals 16.8pF, while for 2nd structure equals 10.1pF. Extracted values show rise in capacitance values that may have been caused by the additional soldered wires for connection with the timer circuit.

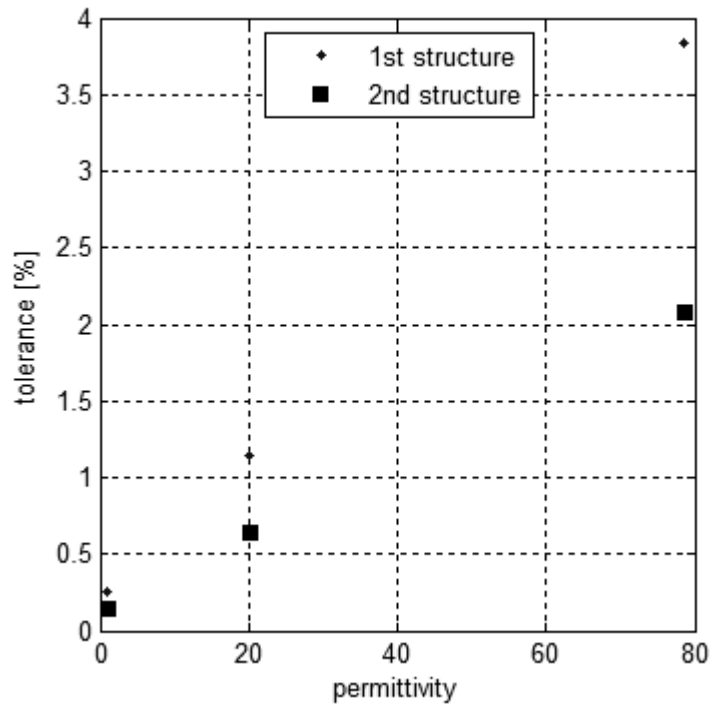

Graph 10: Tolerance obtained when 0-999Hz region is removed from frequency

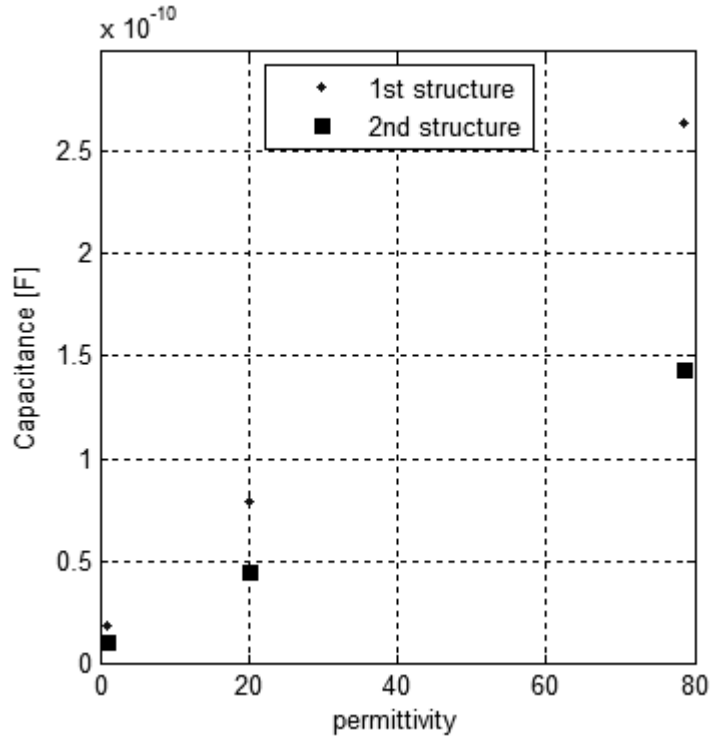

Graph 11: Extracted capacitance from modified frequency

5.2 Performance results

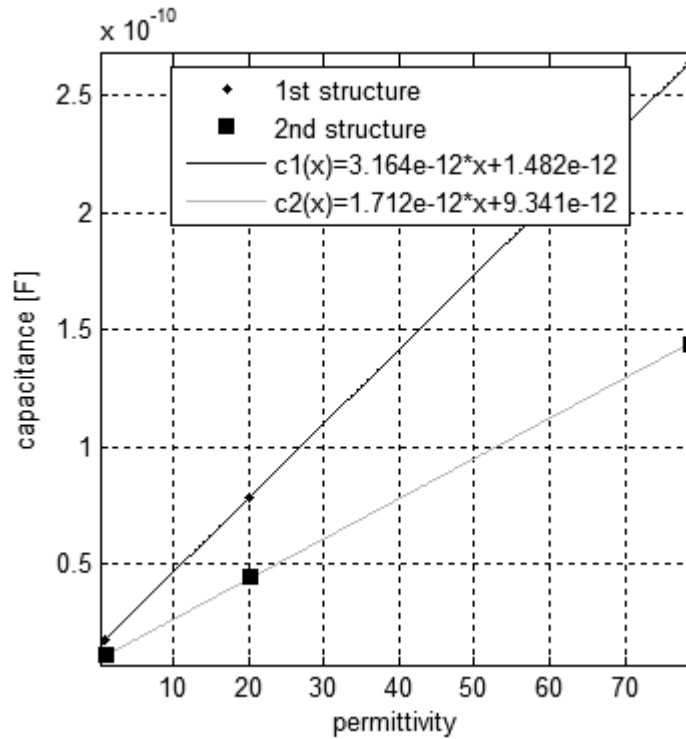

Graph 12: Fitted capacitance changes obtained from extracted data using 99% confidence bound

Using MATLAB a fit has been performed for 1st and 2nd structure (Graph 12). It can be seen that system exhibits linear trend. From fitting equations expected capacitance has been calculated for each liquid used and put into a look-up table in a microcontroller memory. Each capacitance represents liquid used. Microcontroller counts pulses, forms a frequency from which a capacitance is extracted using (45).

This capacitance value is then compared with expected values in a look-up table. If a match is found, info (name of a liquid) is being sent to a display and through RS232 connection on a PC. UART terminal incorporated in micro C has been used. Flow chart of unit's performance is presented in (Fig. 27).

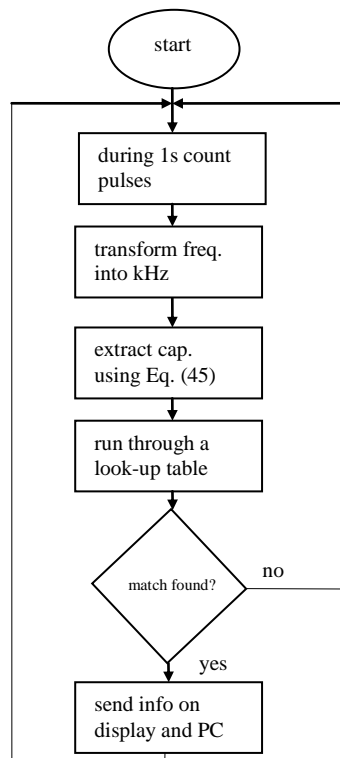
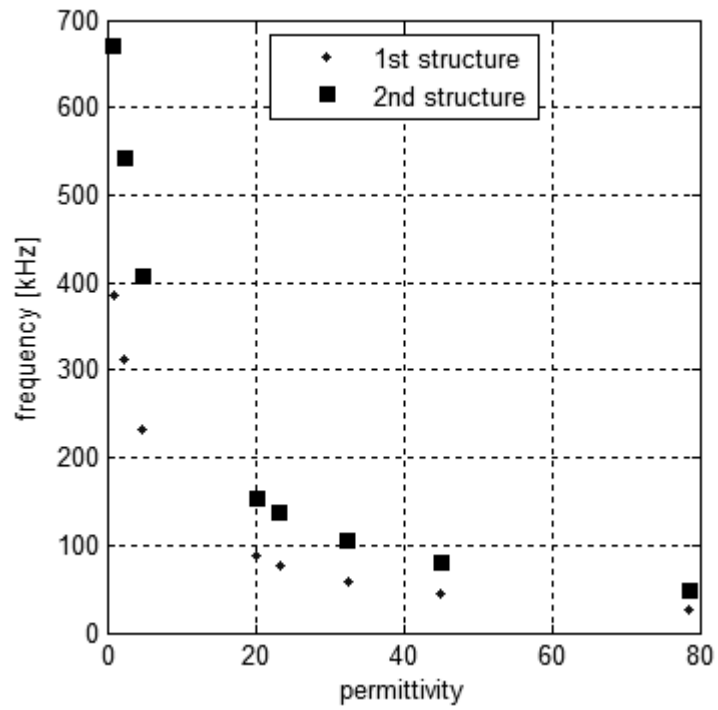
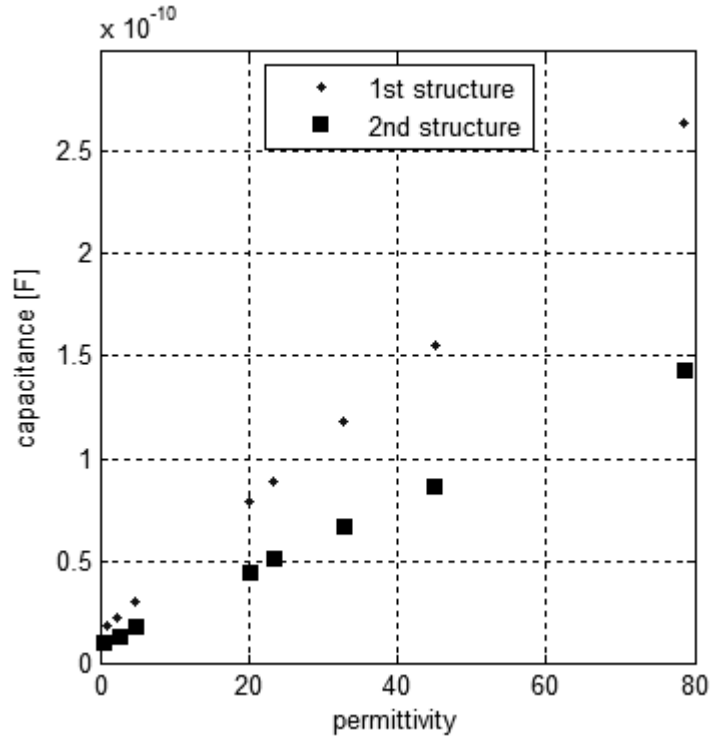

Fig. 27: Flow chart used in microcontroller programming

Unit operation's results are presented on Graph 13 to Graph 15. Unit, in general, exhibits better resolution and accuracy with low permittivity liquids; it is small and practical to built using cheap off-the-shelf components. There's a need to pay intention on calibration process in order to achieve desired accuracy. Once properly calibrated, unit recognizes liquids with 100% success.



Graph 13: Modified frequency used for programming



Graph 14: Extracted capacitance for 8 states

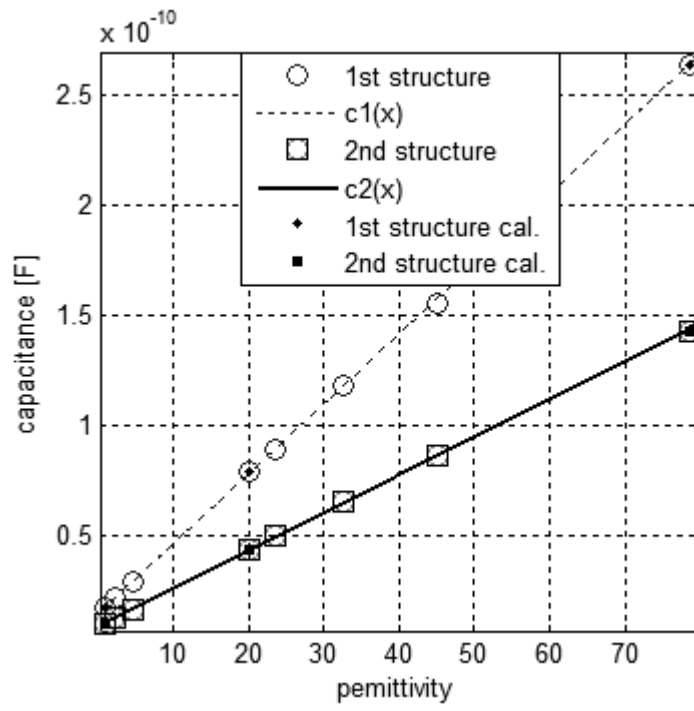

Graph 15: Comparison of extracted capacitance against computed fit

6 NON-INVASIVE DETECTION MECHANISM

For non-invasive approach, insulation layers act as a serial capacitance added onto R_x - C_x cell. Overall resistance of such structure is very high, thus R_x can be omitted, leaving capacitive component as dominant term [133].

As referred to timer basic astable configuration described in Chapter 4, resistors used for PCB IDC were $R_A = 5.1\text{k}\Omega$ and $R_B = 100\text{k}\Omega$, while for paper-based IDC $R_A = 100\text{k}\Omega$ and $R_B = 200\text{k}\Omega$ were chosen. Model of this system is entirely based on the developed system for invasive approach as described in Chapter 5. Only the sensor configuration is changed from invasive into non-invasive.

Programming, for microcontroller dsPIC30f4013, was performed in micro C. UART terminal incorporated in micro C, along with 2x16 character display was used for monitoring and data logging. Generally, this system can be redesigned to interface any communication module.

Containers, as well as IDC sensors were properly wiped clean using acetone and cotton wool. Acetone was used for cleaning due to fast vaporization. Experiments were conducted with liquids in room temperature assumed constant in this study (around 22°C).

Dielectric constants for testing liquids are: benzene $\epsilon_r = 2.3$, olive oil $\epsilon_r = 3.1$, acetone $\epsilon_r = 20.7$, ethanol $\epsilon_r = 24.5$, purified water $\epsilon_r = 29.3$, methanol $\epsilon_r = 33.1$ and formaldehyde $\epsilon_r = 45$.

6.1 Microcontroller programming and calibration

PPC was filled with liquid of interest and placed over the solid IDC so that it covers the electrodes through its full floor surface. After each sample PPC was cleaned with acetone. The same procedure was conducted using GL. dsPIC is set to generate 250ms time window during which it counts timer pulses. During measurements, it was established that reliable difference between samples can be achieved using only kHz region thus providing systems frequency resolution of 1kHz. Frequency readings for solid PCB IDC are reported on Graph 16 .

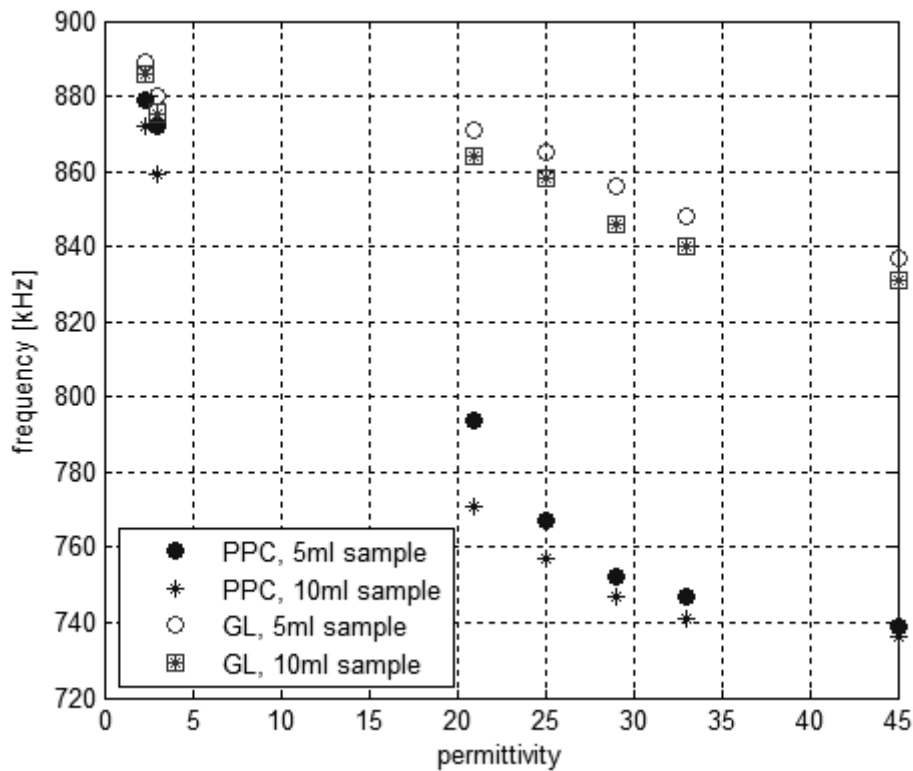

Graph 16: Frequency readings for PPC and GL using solid IDC

As it can be seen, frequency exhibits volume as well as container type dependency. Maximal shifts occur at 10ml sample volume. Solid IDC produces 136kHz frequency shift with PPC compared to 55kHz obtained with glass container.

Paper IDC was taped around syringes filled with samples of interest. Frequency readings obtained for paper IDC are reported on Graph 17. Maximum frequency shift obtained with this structure equals 29kHz.

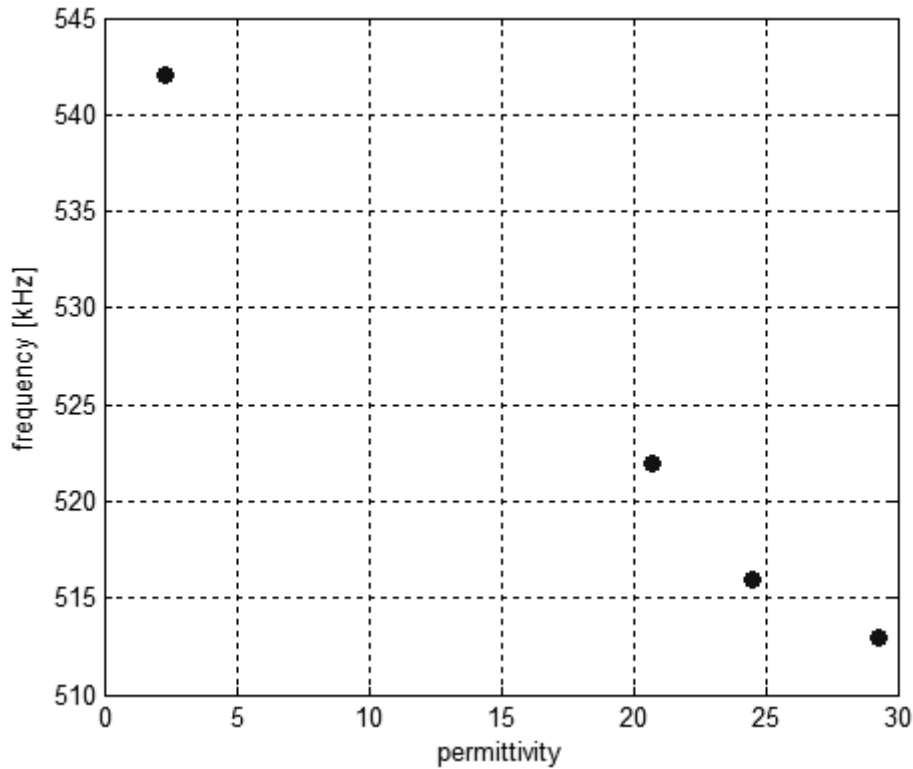

Graph 17: Frequency readings with paper IDC. Liquids used: benzene, acetone, ethanol and purified water

Frequency output function of TLC555 represents a part of a quadratic hyperbole and exhibits the largest sensitivity on the side of lower permittivity samples, while with the increase of permittivity and capacitance growth, system becomes more insensitive.

Partial linearization was performed on frequency bands for solid IDC as depicted in Graph 18. Values used were 10ml volume for both container types as it produced more reliable readings. Linear function of permittivity dependence between two calibration points can be represented as in:

$$x = \frac{f}{a} + \frac{b}{a}, \quad (50)$$

where x represents permittivity, f represents frequency and a and b represent constants of the corresponding linear functions.

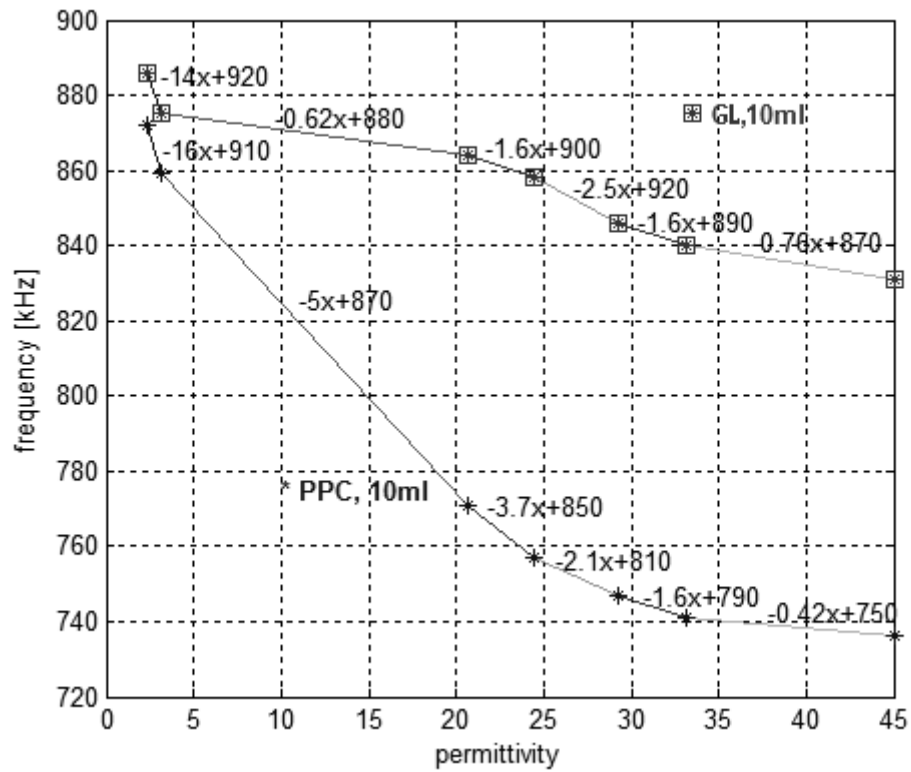

Graph 18: Partial linearization for solid IDC

Rule for how uncertainties propagate when multiplication by a constant is given can be represented by:

$$\Delta x = \frac{1}{a} \times \Delta f. \quad (51)$$

With initial frequency resolution of 1kHz, and polypropylene container used, uncertainty in permittivity measurement is maximally 2.4 at high end, and decreases to

0.1 at low end. When glass container is used, uncertainty is maximally 1.3 and 0.1 minimally.

After performed linearization (Graph 19), it was shown that maximum permittivity uncertainty for paper IDC equals 1.6, while minimum equals 0.9.

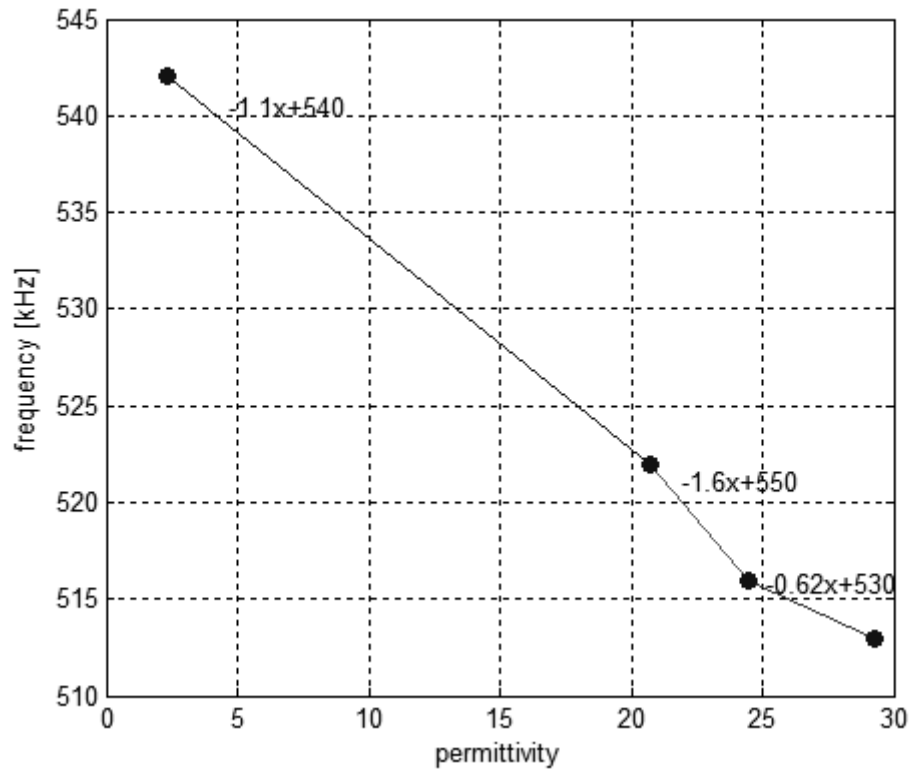

Graph 19: Partial linearization for paper IDC

6.2 Performance results

System configuration is based on invasive approach to liquid recognition as described in Chapter 5. dsPIC counts pulses during 250ms (Fig. 28). Frequency bands, for look-up table, were derived by assuming that only these seven samples need to be discriminated. Performance results are presented on Graph 20 and Graph 21.

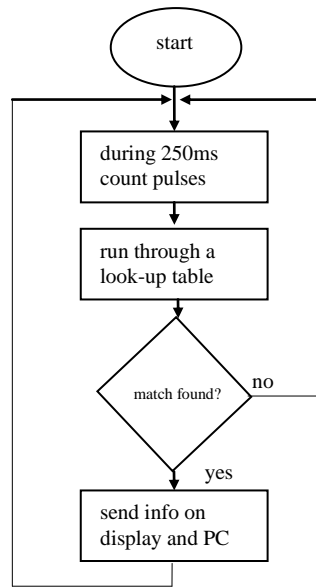
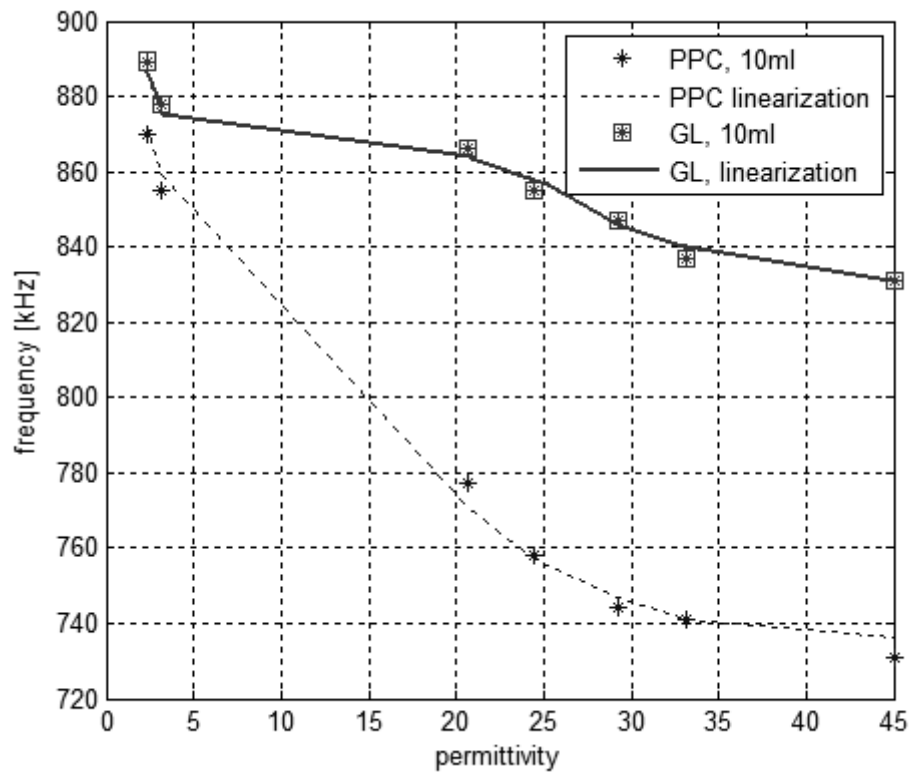
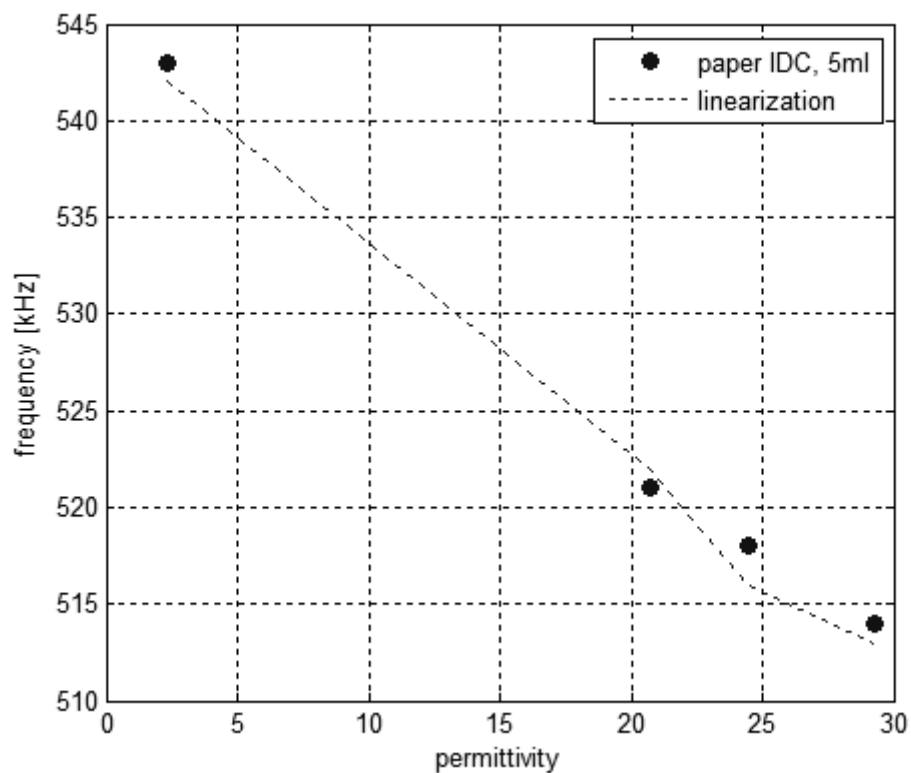

Fig. 28: Flow chart of the system



Graph 20: Solid IDC performance



Graph 21: Paper IDC performance

Table 1 Permittivity uncertainties introduced by look-up table bands for solid IDC

sample	Benzene	Olive oil	Acetone	Ethanol	Water	Methanol	Formaldehyde
PPC	-0.4 +0.4	-0.4 +8.8	-8.8 +1.9	-1.9 +2.3	-2.3 +1.9	-1.9 +6	-6 +6
GL	-0.02 +0.02	-0.02 +14.3	-14.3 +1.2	-1.2 +0.5	-0.5 +1.2	-1.2 +7.8	-7.8 +7.8

Table 2: Permittivity uncertainties introduced by look-up table bands for paper IDC

sample	Benzene		Acetone		Ethanol		Water	
PPC	-9.1	9.1	-9.1	+1.9	-1.9	+2.4	-2.4	+2.4

Theoretical air-capacitance calculated for solid IDC equals 10.4pF, while paper extracted capacitance from actual frequency measurements equals 7.8pF. Theoretical values obtained for IDC fabricated on 0.1mm thick paper with approximately dielectric constant of 4 equals 4.6pF, while extracted value equals 5.1pF. As it can be seen theoretical and measured values are in relatively good agreement. We allowed border frequencies to be at one half between two samples. In this way we introduced additional uncertainty in permittivity estimation. Partial linearization of system's response brings different uncertainties left and right from the target values as reported in Table 1. and 2. With current data set, samples were successfully discriminated, with negligible container positioning influence.

7 THESIS SUMMARY AND FUTURE WORK

Substance analysis and identification has gained on popularity over the past years. Well established techniques and methods, usually available for laboratory use, tend to modify in order to expand in every-day applications. As previously discussed, substance analysis methods relying on physical properties can be divided into classical and instrumental. For low number of pure samples, classical methods are used. However this can still be a time consuming process as well as dangerous if toxic substances are present.

In this thesis, we examine the possibility to speed up the classical method of analysis and replace expensive laboratory equipment with miniature, compact, on-field system with reasonable accuracy and speed. The main goal was to explore the possibility to discriminate between liquid samples based on their dielectric constant. Capacitive sensors have constantly evolving geometry and present study examines the planar IDC structure. Practical usage of the IDC's features, namely the possibility to discriminate between liquids based on the change of the capacitance when interacting with samples, has been investigated.

In invasive approach to liquid discrimination, two solid IDC structures were examined and seven liquids successfully distinguished with very good separation between them, leaving space to further improvement in more precise sensing applications. For the liquids used in this experiment reactive component of capacitance was omitted. In general, better resolution and accuracy was achieved with low

permittivity liquids. System is small and practical to built using cheap off-the-shelf components. There's a need to pay intention on calibration process in order to achieve desired accuracy. Reactive component may corrupt the readings if samples become contaminated with conductive impurities. Also, if aggressive substances are used, damage to the sensor can be permanent. Once properly calibrated, unit recognizes liquids with 100% success.

As some of the substances deteriorate and can be dangerous to handle due to possibility of intoxication of the operator, the purpose of non-invasive approach was to investigate the possibility to recognize samples packed in predefined containers. Glass and polypropylene containers were examined and the effect of sample volume was investigated as well. Special attention was dedicated to vaporizable samples. For that purpose polypropylene syringes were used with flexible paper-based IDC. Because there is no direct contact between electrodes and liquid samples, there is no deterioration issue of the sensor structures and also reactive component of the sample is negligible. The possibility to examine samples without disturbing original containers, improves safety of the operator when dealing with dangerous substances.

However, special care must be taken. Contact surface between PCB IDC and container floor must be smooth in order to achieve maximum performance. Also, glass containers need thicker floors in order to prevent cracks and damaging. This extra thickness affects on electric field penetration height and therefore produces smaller sensitivity. Major disadvantage of the system is the necessity to take samples into previously determined types of containers. Automatic container recognition can be explored. It was shown that sample volume also affects the readings, and therefore this parameter must also be predefined or measured during discrimination process. Accurate container positioning is another important issue needing further attention.

Paper-based IDC showed promising in possibility to use this flexible structure on container walls, which are thinner and uniform in structure. Further investigations of

flexible IDC structures are possible in order to make recognition process available also for pipe-lined processes.

Experimental results confirm that non-invasive approach sufficiently discriminates liquid samples using differences in their permittivity. It offers a useful tool to study the dielectric property of the liquid samples and a satisfactory performance in discrimination between low numbers of liquids. In addition, further studies are needed to achieve better resolution and processing in the real-life environmental condition.

This system can be improved by adding additional interfaces, like GMS modem could be useful for alarming purposes when detecting dangerous substances. Experimental work is necessary in order to expand performance of this system onto mixtures of two or more substances.

REFERENCES

- [1] L. S. Ettre, "Nomenclature for chromatography (IUPAC Recommendations 1993)", *Pure and Applied Chemistry*, 65 (4), (1993).
- [2] S. S. Dukhin, B. V. "Derjaguin, Electrokinetic Phenomena", J. Wiley and Sons, (1974).
- [3] J. C. Giddings, F. J. Yang, M. N. Myers, "Flow Field-Flow Fractionation: a versatile new separation method", *Science*, 193 (4259), 1244-1245, (1976).
- [4] N. A., "Lange's Handbook of Chemistry", McGraw-Hill, New York, (1967).
- [5] "Existing and Potential Stand off Explosives Detection Techniques", Nat. Academies Press, Washington, D.C., 2004.
- [6] "Privacy Impact Assessment for the Stand off Explosives Detection Technology Demonstration Program", Department of Homeland Security (2008).
- [7] W. J. Lyman, W. F. Reehl, D. H. Rosenblatt, "Handbook of chemical property estimation methods: Environmental behavior of organic compounds", American Chemical Society, Washington, DC (United States), (1990).
- [8] S. Crouch, D. A. Skoog, "Principles of instrumental analysis", Australia: Thomson Brooks/Cole, (2007).
- [9] G. Guetens, G. De Boeck, M. Wood, R. A. A. Maes, A. A. M. Eggermont, A. Hanauske, E. A. De Bruijn, U. R. Tjaden, "Hyphenated techniques in anticancer drug monitoring", *Journal of chromatography A*, 976 (1-2), 239-247, (2002).
- [10] Abe, H., Esashi, M., and Matsuo, T., "ISFETs Using Inorganic Gate Thin Films", *IEEE Transactions on Electronic Devices*, ED-26 (12), 1939-1944, (1979).

- [11] Johnson, C. L., Wise K. D., and Schwank, J. W., "A Thin-Film Gas Detector for Semiconductor Process gases", Digest of the International Electron Devices Meeting (IEDM), 662, San Francisco, CA, (1988).
- [12] Kondoh, J., and Shiokawa, S., "Liquid Identification Using SH-SAW Sensors", Proceedings of Transducers '95, the 8th International Conference on Solid State Sensors and Actuators, 2, 716-719, Stockholm, Sweden, (1995).
- [13] Kang, J., Kim, Y., Kim, H., Jeong, J., and Park, S., "Comfort Sensing System for Indoor Environment", Proceedings of Transducers '97, the 1997 International Conference on Solid-State Sensors and Actuators, 1, 311-314, Chicago, (1997).
- [14] J. Lavigne, S. Savoy, M. B. Clevenger, B. McDaniel, S. J. Yoo, E. V. Anslyn, J. T. McDevitt, J. Shear, and D. Niekirk, "Solution-based Analysis of Multiple Analytes by a Sensor Array: Toward the Development of an "Electronic Tongue", J. Am. Chem. Soc., 120, 6429-6430, (1998).
- [15] A. Goodey, J. J. Lavigne, S. M. Savoy, M. Rodriguez, T. Curey, A. Tsao, G. Simmons, J. Wright, S. J. Yoo, Y. Sohn, E. V. Anslyn, J. B. Shear, D. P. Neikirk, J. T. McDevitt, "Development of Multi analyte Sensor Arrays Composed of Chemically Derivatized Polymeric Microspheres Localized in Micromachined Cavities", J. Am. Chem. Soc., 123 (11), 2559-2570, (2001).
- [16] Gwynne, Peter, "Microfluidics on move: devices offer many advantages", OEReports, 200, (2000).
- [17] L.D. Landau, E.M. Lifshitz, "Electrodynamics of continuous media", Oxford: Pergamon Press, (1963).
- [18] Mudgett, R., "Electrical properties of foods", In: Engineering properties of foods, (2nd ed.), Marcel Dekker, New York (NY), (1995).
- [19] M. A. Rao, S. S. H. Rizvi, "Engineering properties of foods", (2nd ed.), Marcel Dekker, New York (NY), 389-455, (1995).

- [20] Nelson, S., "Dielectric properties of agricultural products: measurements and applications", *IEEE Transactions of Electrical Insulation*, 26 (5), 845-869, (1991).
- [21] Nicolson, A., & Ross, G., "Measurement of the intrinsic properties of materials by time domain techniques", *IEEE Transactions on Instrumentation and Measurement*, 19 (4), 377-382, (1970).
- [22] Oliveira, M., & Franca, A., "Microwave heating of foodstuffs", *Journal of Food engineering*, 53 (4), 347-359, (2002).
- [23] Golio, M., "Microwave and RF product applications", CRC Press, London (UK), (2003).
- [24] A. V. Mamishev, Y. Du, B. C. Lesieutre, and M. Zahn, "Development and Applications of Fringing Electric Field Sensors and Parameter Estimation Algorithms", *Journal of Electrostatics*, 46, 109-123, (1999).
- [25] N. Delmonte, B. E. Watts, G. Chiorboli, P. Cova, R. Menozzi, "Test structures for dielectric spectroscopy of the thin films at microwave frequencies", *Microelectronics Reliability*, 47, 682-685, (2007).
- [26] P. Van Gerwen et al., "Nanoscaled interdigitated electrode arrays for biochemical sensors", *Sensors and Actuators B*, 49, 73-80, (1998).
- [27] L. Montelius, J. Tegenfeldt, T. Ling, "Fabrication and characterization of a nanosensor for admittance spectroscopy of biomolecules", *J. Vac. Sci. Technol. A*, 13 (3), 1755-1760, (1995).
- [28] P. Jacobs et al. "Impedimetric detection of nucleic acid hybrids", *Proceedings of the Second International Conference on Microreaction Technology*, New Orleans, LA, March, 8-12, (1998).
- [29] C. Hagleitner, A. Hierlemann, D. Lange, A. Kummer, N. Kerness, O. Brand, H. Baltes, "Smart single-chip gas sensor microsystems", *Nature*, 414, 293-296, (2001).

- [30] A. V. Mammishev, S. R. Kishore, F. Yang, Y. Du, M. Zahn, “Interdigital Sensors and Transducers”, Proceedings of the IEEE, 92 (5), 808-845, (2004).
- [31] Encyclopedia Britannica.
- [32] Application Note 1217-1, “Basics of measuring the dielectric properties of materials”, Hewlett Packard literature number 5091-3300E, (1992).
- [33] G. S. V. R. M.S.Venkatesh, “An Overview of Dielectric Properties Measuring Techniques”, The Journal of The Canadian Society for Bioengineering (CSBE), 47, 715-730, (2005).
- [34] M. F. Iskander and J. B. DuBow., ”Time- and Frequency-Domain Techniques for Measuring the Dielectric Properties of Rocks: A Review”, Journal of Microwave Power, 18 (1), 55-74, (1983).
- [35] A. Rajendran and P. Neelamegam., “Dielectric Constant Measurement Using an Artificial Neural Network”, Instrumentation Science & Technology, 32 (4), 413-422, (2004).
- [36] M. F. S. Kashif Saeed, Matthew B. Byrne, Ian C. Hunter Ed., Planar “Microwave Sensors for Complex Permittivity Characterization of Materials and Their Applications”, Applied Measurement Systems. In-Tech, 319-350, (2012).
- [37] R. Bartnikas, “Dielectric measurement”, Wiley Encyclopedia of Electrical and Electronics Engineering Online, Wiley, New York, (1999).
- [38] Linfeng Chen, V.K. Varadan, “Microwave Electronics: Measurement and Materials Characterization”, John Wiley and Sons, (2004).
- [39] J. Baker-Jarvis, R.G. Geyer, J.H. Grosvenor Jr., M.D. Janezic, C.A. Jones, B. Riddle, et al., “Dielectric characterization of low-loss materials – a comparison of techniques”, IEEE Trans. Dielectr. Electr. Insul., 5 (4), 571–577, (1998).

- [40] C. Qian, W.B. Dou, “A new approach for measuring permittivity of dielectric materials”, *J. Electromagn. Wave Appl.*, 19, 795–810, (2005).
- [41] M.N. Afsar, J.R. Birch, R.N. Clarke, “The measurement of the properties of materials”, *Proc. IEEE*, 74, 183–199, (1986).
- [42] J. Krupka, R.G. Geyer, “Loss-angle measurement”, *Wiley Encyclopedia of Electrical and Electronics Engineering Online*, Wiley, New York, (1999).
- [43] S. Aditya, A. Arokiaswami, “Microwave measurement instrumentation”, *Wiley Encyclopedia of Electrical and Electronic Engineering Online*, Wiley, New York, (1999).
- [44] C. Qian, W.B. Dou, “A new approach for measuring permittivity of dielectric materials”, *J. Electromagn. Wave Appl.*, 19, 795–810, (2005).
- [45] A. Bogle, M. Havrilla, D. Nyquis, L. Kempel, E. Rothwell, “Electromagnetic material characterization using a partially filled rectangular waveguide”, *J. Electromagn. Wave Appl.*, 19, 1291–1306, (2005).
- [46] N. Tesla, “Electric condenser”, U.S. Patent 464 667, (1891).
- [47] E. H. Love, “Some electrostatic distributions in two dimensions”, in *Proc. London Mathematical Soc.*, 22, 339–369, (1923).
- [48] S. D. Senturia and C. M. Sechen, “The use of the charge-flow transistor to distinguish surface and bulk components of thin-film sheet resistance”, *IEEE Trans. Electron Devices*, ED-24 (9), 1207, (1977).
- [49] W. S. Mortley, “Pulse compression by dispersive gratings on crystal quartz”, *Marconi Rev.*, 59, 273–290, (1965).

- [50] I. G. Matis, "On multiparameter control of dielectric properties of laminate polymer materials", *Latvijas PSR Zinatnu Akademijas Vestis Fizikas un Tehnisko*, 6, 60–67, (1966).
- [51] R. S. Jachowicz and S. D. Senturia, "A thin-film capacitance humidity sensor", *Sens. Actuators*, 2 (2), 171–186, (1981).
- [52] M. C. Zaretsky and J. R. Melcher, "Complex permittivity measurements of thin films using microdielectrometry", in *Proc. Conf. Electrical Insulation and Dielectric Phenomena*, 462–471, (1986).
- [53] N. J. Goldfine, A. P. Washabaugh, J. V. Dearlove, and P. A. Von Guggenberg, "Imposed omega-k magnetometer and dielectrometer applications", in *Review of Progress in Quantitative Nondestructive Evaluation*. New York: Plenum, 12, 1115–1122, (1993).
- [54] Wei JS., "Distributed capacitance of planar electrodes in optic and accustic surface wave devices", *IEEE Journal of Quantum Electronics*, QE-13 (4), 152-158, (1977).
- [55] Hoffman RK., "Handbook of Microwave Integrated Circuits", Norwell MA: Artech, (1987).
- [56] Zaretsky MC, Mouayad L, Melchor JR., "Continuum properties from interdigital electrode dielectrometry", *IEEE Transactions on Electrical Insulation*, 23 (6), 897-917, (1988).
- [57] Casalini R, Kilitziraki M, Wood D, Petty MC., "Sensitivity of the electrical admittance of a polysiloxane film to organic vapours", *Sensor and Actuators B*, 56 (1-2), 37-44, (1999).
- [58] Zhou R, Hierlemann A, Weimar U, Göpel W., "Gravimetric, dielectric and calorimetric methods for the detection of organic solvent vapours using poly(ether urethane) coatings", *Sensor and Actuators B*, 34 (1), 356-360, (1996).

- [59] J.W. Kim, “Development of Interdigitated Capacitor Sensors for Direct and Wireless Measurements of the Dielectric Properties of Liquids”, Ph.D. Dissertation, Department of Electrical and Computer Engineering, University of Texas, Austin, USA, (2008).
- [60] P. Salvo, F.D. Francesco, D. Costanzo, C. Ferrari, M.G. Trivella, D.D. Rossi, “A wearable sensor for measuring sweat rate”, *IEEE Sens. J.*, 10 (10), 1557–1558, (2010).
- [61] S. Sivaramakrishnan, R. Rajamani, B.D. Johnson, “Dynamic model inversion techniques for breath-by-breath measurement of carbon dioxide from low bandwidth sensors”, *IEEE Sens. J.*, 10 (10), 1637–1646, (2010).
- [62] H.S. Kim, S. Sivaramakrishnan, A.S. Sezan, R. Rajamani, “A novel real time capacitance estimation methodology for battery-less wireless sensor systems”, *IEEE Sens. J.*, 10 (10), 1647–1657, (2010).
- [63] X. Zhuang, M.L.C. Sing, C. Cordier, S. Saez, C. Dolabdjian, J. Das, J. Gao, J. Li, D. Viehland, “Analysis of noise in magnetoelectric thin-layer composites used as magnetic sensors”, *IEEE Sens. J.*, 11 (10), 2183–2188, (2011).
- [64] J. Ye, L. Peng, W. Wang, W. Zhou, “Optimization of helical capacitance sensor for void fraction measurement of gas–liquid two-phase flow in a small diameter tube”, *IEEE Sens. J.*, 11 (10), 2189–2196, (2011).
- [65] G. Yu, X. Bu, B. Yang, Y. Li, C. Xiang, “Differential-type GMI magnetic sensor based on longitudinal excitation”, *IEEE Sens. J.*, 11 (10), 2273–2278, (2011).
- [66] K. Watanabe, Y. Taka, O. Fujiwara, “Cole–Cole measurement of dispersion properties for quality evaluation of red wine”, *Meas. Sci. Rev.*, 9 (5), 113–116, (2009).
- [67] Y.K. Yeow, Z. Abbas, K. Khalid, “Application of microwave moisture sensor for determination of oil palm fruit ripeness”, *Meas. Sci. Rev.*, 10 (1), 7–14, (2010).

- [68] Md. N. Alam, R. H. Bhuiyan, R. A. Dougal, M. Ali, “Concrete Moisture Content Measurement Using Interdigitated Near-Field Sensors”, *IEEE sensors journal*, 10 (7), 1243, (2010).
- [69] A. Abu, Al Aish, M. Rehman, M.Z. Abdullah, A.H. Abu Hassan, “Microcontroller based capacitive mass measuring system”, *Measurement Science Review*, 10 (1), 15–18, (2010).
- [70] S. Zhang, “Interdigitated Capacitor Sensor for Complex Dielectric Constant Sensing”, M.S. Thesis, Department of Electrical and Computer Engineering, University of Texas, Austin, USA, (2010).
- [71] K.G. Ong, C.A. Grimes, “A resonant print circuit sensor for remote query monitoring of environmental parameters, *Smart Mater*”. *Struct.*, 9 (4), 421–428, (2000).
- [72] S.C. Mukhopadhyay, C.P. Gooneratne, “A novel planar-type biosensor for noninvasive meat inspection”, *IEEE Sens. J.*, 7 (9), 1340–1346, (2007).
- [73] S.C. Mukhopadhyay, C.P. Gooneratne, G.S. Gupta, S.N. Demidenko, “A low cost sensing system for quality monitoring of dairy products”, *IEEE Trans. Instrum. Meas.*, 55 (4), 1331–1338, (2006).
- [74] C. Laville, C. Pellet, “Interdigitated humidity sensors for a portable clinical microsystem”, *IEEE Trans. Biomed. Eng.*, 49 (10), 1162–1167, (2002).
- [75] S.M. Radke, E.C. Alocilja, “Design and fabrication of a microimpedance biosensor for bacterial detection”, *IEEE Sens. J.*, 4 (4), 434–440, (2004).
- [76] S.M. Radke, E.C. Alocilja, “A high density microelectrode array biosensor for detection of *E. coli* O154:H7”, *Biosens. Bioelectron.*, 20 (8), 1662–1667, (2005).
- [77] S.M. Radke, E.C. Alocilja, “A microfabricated biosensor for detecting foodborne bioterrorism agents”, *IEEE Sens. J.*, 5 (4), 744–750, (2005).

- [78] M. Varshney, Y. Li, "Interdigitated array microelectrodes based impedance biosensors for detection of bacterial cells", *Biosens. Bioelectron.*, 24 (10), 2951-2960, (2009).
- [79] A.R.M. Syaifudin, K.P. Jayasundera, S.C. Mukhopadhyay, "A low cost novel sensing system for detection of dangerous marine biotoxins in seafood", *Sens. Actuators B*, 137 (1), 67-75, (2009).
- [80] Alley, G. D., "Interdigital Capacitors and Their Applications to Lumped Element Microwave Integrated Circuits", *IEEE Trans. Microwave Theory Tech.*, MTT-18, 1028-1033, (1970).
- [81] J. S. Wei, "Distributed capacitance of planar electrodes in optic and acoustic surface wave devices", *IEEE J. Quantum Electron.*, QE-13, 152-158, (1977).
- [82] J.L. Hobdell, "Optimization of interdigital capacitors", *IEEE Trans. Microwave Theory Tech.*, MTT-27, 788-791, (1979).
- [83] R. Esfandiari, D.W. Maki, M. Siracusa, "Design of interdigitated capacitors and their application to gallium arsenide monolithic filters", *IEEE Trans. Microwave Theory Tech.*, 31, 57-64, (1983).
- [84] H.D. Wu, Z. Zhang, F. Barnes, C.M. Jackson, A. Kain, J.D. Cuchiario, "Voltage tunable capacitors using high temperature superconductors and ferroelectrics", *IEEE Trans. Appl. Supercond.*, 4, 156-160, (1994).
- [85] C. Veyres and F. Hanna, "Extension of the application of conformal mapping techniques to coplanar lines with finite dimensions", *Int. J. Electronics*, 48 (1), 47-56, (1980).
- [86] S. S. Gevorgian, T. Martinsson, Peter L, J. Linner, E. L. Kollberg, "CAD models for multilayered substrate interdigital capacitors", *IEEE Trans. Microwave Theory and Techniques*, 44 (6), 896-904, (1996).

- [87] R. Igreja and C. J. Dias, “Analytical evaluation of the interdigital electrodes capacitance for a multi-layered structure”, *Sensors and Actuators A: Physical*, 112 (2-3), 291-301, (2004).
- [88] R. Igreja, C.J. Dias, “Extension to the analytical model of the interdigital electrodes capacitance for a multilayered structure”, *Sens. Actuators A*, 172, 392-399, (2011).
- [89] A. Vuković Rukavina, “Non-invasive liquid recognition based on interdigital capacitor”, *Sensors and Actuators A*, 228, 145–150, (2015).
- [90] A. Vuković Rukavina, “Hand-held unit for liquid type recognition, based on interdigital capacitor”, *Measurement*, 51, 289-296, (2014).
- [91] Bin Yao, Longyan Yuan, Xu Xioa, Jing Zhang, Yanyuan Qi, Jing Zhou, Jun Zhou, BinHu, Wen Chen, “Paper-based solid-state supercapacitors with pencil-drawinggraphite/polyaniline networks hybrid electrodes”, *Nano Energy*, 2 (6), 1071–1078, (2013).
- [92] I. C. Shay and M. Zahn, “Cylindrical Geometry Electroquasistatic Dielectrometry Sensors”, *IEEE Conference on Electrical Insulation and Dielectric Phenomena*, 126-129, (2002).
- [93] A. A. Nassr, W. H. Ahmed, and W. W. El-Dakhakhni, “Coplanar capacitance sensors for detecting water intrusion in composite structures”, *Meas. Sci. Technol.*, (2008), doi:10.1088/0957-0233/19/7/075702.
- [94] A. A. Nassr and W. W. El-Dakhakhni, “Non-destructive evaluation of laminated composite plates using dielectrometry sensors”, *Smart Mater. Struct.*, (2009), doi:10.1088/0964-1726/18/5/055014.
- [95] W. Q. Yang and L. Peng, “Image reconstruction algorithms for electrical capacitance tomography”, *Meas. Sci. Technol.*, 14 (R1-R13), 35, (2003).

- [96] W. Q. Yang, "Hardware design of electrical capacitance tomography systems", *Meas. Sci. Technol.*, 7, 225-232, (1996).
- [97] S. M. Huang, C. G. Xie, R. Thorn, D. Snowden, and M. S. Beck, "Design of sensor electronics for electrical capacitance tomography", *IEE Proc. G*, 139, 83-88, (1992).
- [98] L. Peng, C. Mou, D. Yao, B. Zhang and D. Xiao, "Determination of the optimal axial length of the electrode in an electrical capacitance tomography sensor", *Flow Measurement and Instrumentation*, 16, 169-175, (2005).
- [99] S. O. Nelson, S. Trabelsi, and A. W. Kraszewski, "RF Sensing of Grain and Seed Moisture Content," *IEEE Sensors Journal*, 1 (2), 119-126, (2001).
- [100] A. V. Mamishev, Y. Du, B. C. Lesieutre, and M. Zahn, "Measurement of Moisture Spatial Profiles in Transformer Pressboard," *IEEE Conference on Electrical Insulation and Dielectric Phenomena*, 323-326, (1998).
- [101] D. D. Denton, J. B. Camou, and S. D. Senturia, "Effects of Moisture Uptake on the Dielectric Permittivity of Polyimide Films," *Proceedings of the 1985 International Symposium on Moisture and Humidity*, 505-513, (1985).
- [102] G. Ghione, M. Goano, "Revisiting the partial-capacitance approach to the analysis of coplanar transmission lines on multilayered substrates", *IEEE Transactions on Microwave Theory and Techniques*, 51, 2007–2014, (2003).
- [103] J. O. Simpson and S. A. Bidstrup, "Modeling conductivity and viscosity changes during epoxy cure using TEA DMA and DSC," in *Proc. Amer. Chemical Soc. Division of Polymeric Materials: Science and Engineering Fall Meeting*, 69, 451–452, (1993).
- [104] M. C. Zaretsky, P. Li, and J. R. Melcher, "Estimation of thickness, complex bulk permittivity and surface conductivity using interdigital dielectrometry," *IEEE Trans. Elect. Insulation*, 24, 1159–1166, (1989).

- [105] M. C. Zaretsky, J. R. Melcher, and C. M. Cooke, "Moisture sensing in transformer oil using thin-film microdielectrometry," *IEEE Trans. Elect. Insulation*, 24 (6), 1167–1176, (1989).
- [106] Y. K. Sheiretov and M. Zahn, "Dielectrometry measurements of moisture dynamics in oil-impregnated pressboard," *IEEE Trans. Dielect. Elect. Insulation*, 2, 329–351, (1995).
- [107] P. A. von Guggenberg and M. C. Zaretsky, "Estimation of one-dimensional complex-permittivity profiles: a feasibility study," *J. Electrostat.*, 34 (2–3), 263–277, (1995).
- [108] P. Li, "Low frequency, millimeter wavelength, interdigital dielectrometry of insulating media in a transformer environment," M.S. thesis, Dept. Elect. Eng. Comput. Sci., Massachusetts Inst. Technol., Cambridge, (1987).
- [109] A. V. Mamishev, B. C. Lesieutre, and M. Zahn, "Optimization of multi wavelength interdigital dielectrometry instrumentation and algorithms," *IEEE Trans. Dielect. Elect. Insulation*, 408–420, (1998).
- [110] J. Melcher, Y. Daben, and G. Arlt, "Dielectric effects of moisture in polyimide," *IEEE Trans. Elect. Insulation*, 24, 31–38, (1989).
- [111] M. C. Zaretsky, "Parameter estimation using microdielectrometry with application to transformer monitoring," Ph.D. dissertation, Dept. Elect. Eng. Comput. Sci., Massachusetts Inst. Technol., Cambridge, (1987).
- [112] N. F. Sheppard, D. R. Day, H. L. Lee, and S. D. Senturia, "Microdielectrometry," *Sens. Actuators*, 2 (3), 263–274, (1982).
- [113] P. M. David, "History of SAW devices," in *Proc. 1998 IEEE Int. Frequency Control Symp.*, 439–460, (1998).

- [114] R. M. White and F. M. Voltmer, "Direct piezoelectric coupling to surface elastic waves," *Appl. Phys. Lett.*, 7, 314–316, (1965).
- [115] I. N. Court, "Microwave acoustic devices for pulse compression filters," *IEEE Trans. Microwave Theory Tech.*, MTT-17, 968–986, (1969).
- [116] R. M. White, "Surface elastic waves," *Proc. IEEE*, 58, 1238–1276, (1970).
- [117] <http://na.tm.keysight.com/materials/docs/SupportedVNAs.pdf>
- [118] www.microchip.com
- [119] T. Fen-chong, A. Fabbri, J. Guilbaud, O. Coussy, "Determination of liquid water content and capacitance dielectric constant in porous media by the capacitive method", *Mecanique*, 332, 639–645, (2004).
- [120] A. Jaworek, A. Krupa, "Gas/liquid ratio measurements by rf resonance capacitance sensor", *Sens. Actuators A*, 113, 133–139, (2004).
- [121] M. Demori, V. Ferrari, D. Strazza, P. Poesio, "A capacitive sensor for the analysis of two-phase flows of oil and conductive water", *Sens. Actuators A*, 163, 172–179, (2010).
- [122] D.M.G. Preethichandra, K. Shida, "A simple interface circuit to measure very small capacitance changes in capacitive sensors", *IEEE Trans. Instrum. Meas.*, 50 (6), 1583–1586, (2001).
- [123] J.C. Lotters, W. Olthuis, P. Bergveld, "A sensitive differential capacitance to voltage converter for sensor applications", *IEEE Trans. Instrum. Meas.*, 48 (1), 89–96, (1999).
- [124] C.K. Alexander, M.N.O. Sadiku, "Fundamentals of Electric Circuits", McGraw Hill, (1999).

- [125] F. Reverter, L. Xiujun, C.M.M. Gerard, “Liquid-level measurement system based on a remote grounded capacitive sensor”, *Sens. Actuators A*, 138 (1–8), (2007).
- [126] www.ti.com/clocks.
- [127] A. P. Gregory, A. P. and R. N. Clarke, “Tables of the Complex Permittivity of Dielectric Reference Liquids at Frequencies up to 5 GHz”, NPL Report CETM, 33ISSN, 1467-3932, (20014).
- [128] L. Rusiniak, “Electric properties of water. New experimental data in the 5Hz-13MHz frequency range”, *Acta Geophysica Polonica*, 52 (1), (2004).
- [129] K. Chetpattananondha, T. Tapoanoib, P. Phukpattaranonta, N. Jindapetch, “A self-calibration water level measurement using an interdigitalcapacitive sensor”, *Sensors and Actuators A*, 209, 175–182, (2014).
- [130] H. Golnabi, “Measurements of the electrical parameters for different water samples”, *Measurement*, 44 (10), 2175-2184, (2011).
- [131] G. Behzadi, L. Fekri and H. Golnabi, “Effect of the reactance term on the charge/discharge electrical measurements using cylindrical capacitive probes”, *Journal of Applied Sciences*, 11 (18), 3293-3300, (2011).
- [132] H. Golnabi, P. Azimi, “Design and performance of a cylindrical capacitor sensor to monitor the electrical properties”, *Journal of Applied Sciences*, 8(9), 1699-1705, (2008).
- [133] G. Behzadia, H. Golnabi, “Comparison of invasive and non-invasive cylindrical capacitive sensors for electrical measurements of different water solutions and mixtures”, *Sensors and Actuators A*, 167 359–366, (2013).

VITAE

Aleksandra Vuković Rukavina received the professional degree of bachelor with honors in electrical and computer engineering (2010), as well as the academic degree of master in electrical engineering (2011) from Faculty of Technical Sciences, University of Novi Sad, Serbia. She is currently on her PhD studies at Faculty of Technical Sciences, University of Novi Sad, Serbia as a researcher through scholarship gained on project III 43008. Her research interests include sensors, microcontrollers and applied electronics. During her work on this thesis two articles were published in eminent journals:

A. Vuković Rukavina, “Non-invasive liquid recognition based on interdigital capacitor”, *Sensors and Actuators A*, 228, 145–150, (2015).

A. Vuković Rukavina, “Hand-held unit for liquid type recognition, based on interdigital capacitor”, *Measurement*, 51, 289-296, (2014).

This dissertation was typed by the author.

This dissertation is equal with its printed version.

APPENDIX 1

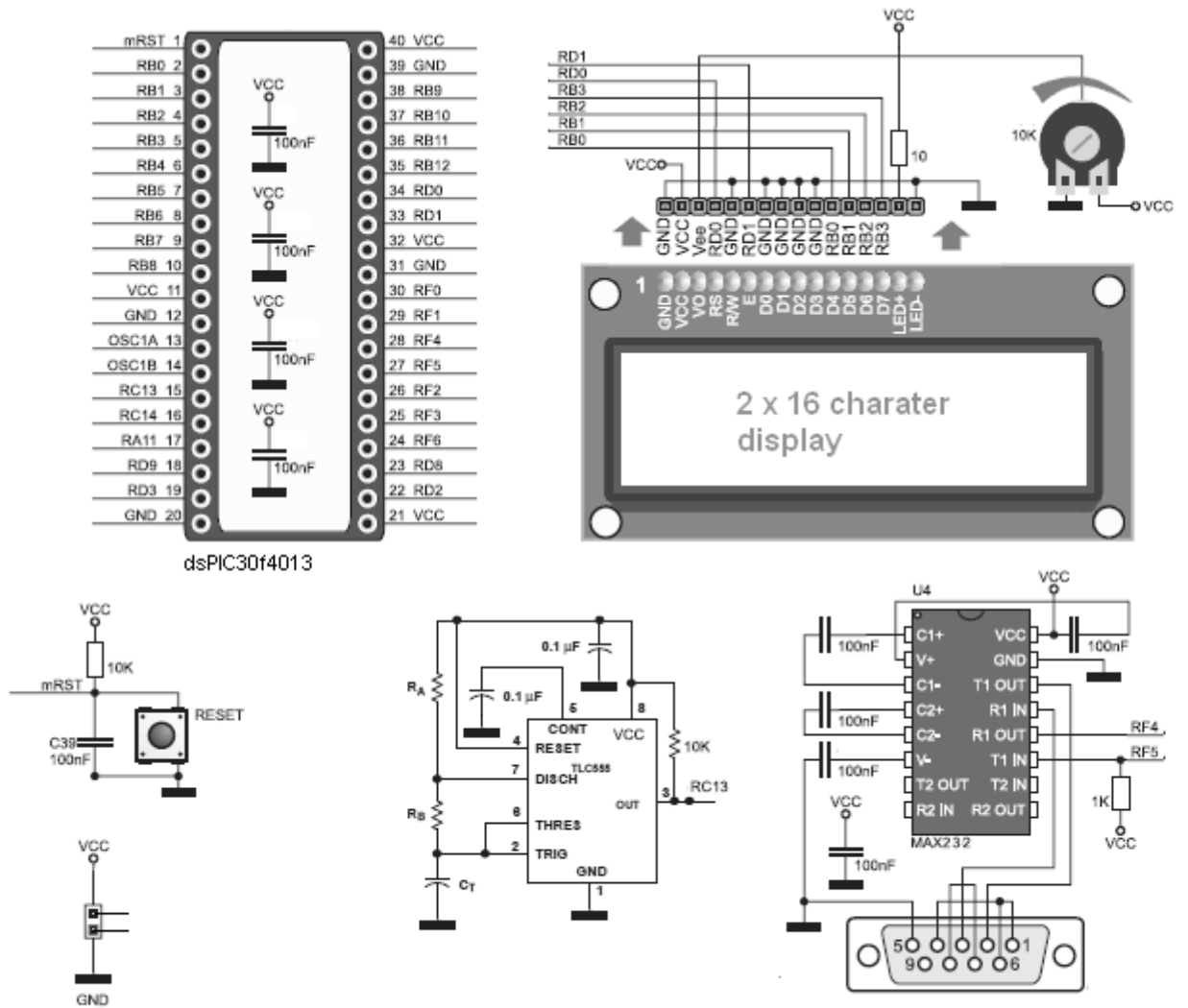

Fig. 1: Schematic of the implemented system