

UNIVERSITY OF BELGRADE
School of Electrical Engineering

Marko Č. Batić

**Software system for multi-criteria
planning and management of hybrid
microgrids**

Doctoral Dissertation

Belgrade, 2019

UNIVERZITET U BEOGRADU

Elektrotehnički fakultet

Marko Č. Batić

**Softverski sistem za više-
kriterijumsko planiranje i upravljanje
hibridnom mikro-mrežom**

Doktorska disertacija

Beograd, 2019

Podaci o mentoru i članovima komisije

Mentor:

dr Sanja Vraneš, redovni profesor, Elektrotehnički fakultet u Beogradu

Članovi komisije:

dr Boško Nikolić, redovni profesor, Elektrotehnički fakultet u Beogradu

dr Nikola Tomašević, naučni saradnik, Institut Mihajlo Pupin u Beogradu

dr Milo Tomašević, redovni profesor, Elektrotehnički fakultet u Beogradu

dr Željko Đurišić, docent, Elektrotehnički fakultet u Beogradu

Datum usmene odbrane:

Acknowledgements

The research presented in this thesis was partly funded by the Ministry of Education, Science and Technological Development of Republic of Serbia (SOFIA project, Pr. No: TR-32010) and partly by the European Union (FP7 ENERGY WARDEN project, Pr. No.: 246745; FP7 CASCADE project, Pr. No.: 284920; FP7 EPIC-HUB project, Pr. No.: 600067).

Software system for multi-criteria planning and management of hybrid microgrids

Abstract

Efficient operation and management of energy systems in the context of increasing penetration of distributed resources and renewable energy sources combined with energy storages, grid-tied configurations and deregulated energy market context pose a complex energy-dispatching problem, the one conventional energy management systems are not able to cope with. This complexity also hinders faster adoption of renewables and aggravates their cost effectiveness. This thesis proposes an innovative software system, which brings advanced microgrid planning, and operation algorithms while leveraging existing supervision and control systems to collect data and information from the field level but also to forward desired control action. Moreover, the thesis also proposes innovative approach for seamless integration with diverse, legacy, ICT systems thus contributing to system large-scale applicability. Following is a breakdown of concrete results and outputs with emphasis on their specific advancements compared to existing approaches. Similarly, to existing approaches the underlying methodology of microgrid planning tool considers hybrid energy infrastructures with both conventional and renewable energy sources, converters and storages, featured by their mathematical representation. However, proposed methodology advances existing tools and planning approaches by simultaneously considering both electric and thermal energy domain, by considering both grid-tied and isolated deployment scenarios and, foremost, by leveraging demand side flexibility for optimized dimensioning of energy assets. Moreover, multi-criteria decision-making algorithms are used to rank multiple feasible planning alternatives. For the purpose of determining expected energy demand profile, an approach to leverage user habits and behaviour together with characteristics of existing energy infrastructure, rather than building physics, was developed.

The developed microgrid management tool aimed at providing additional intelligence to existing supervision and control systems resulting in the cost savings typically exceeding 10%, as demonstrated in a real world use case, at the cost of ICT system retrofit. The achieved level of cost savings is comparable to those of retrofit of energy assets, which

require considerable higher investments. The underlying microgrid management methodology complements existing approaches that optimize energy imports for a desired demand and available storages, by introducing appliance-level demand response actions, which can be immediately translated into control actions. Lastly, an ontology-based facility model of complex facilities and corresponding energy infrastructure was developed together with unified messaging format to enable semantic interoperability of existing diverse, legacy, supervision and control systems, which use proprietary communication protocols. By employing semantic web technologies and leveraging existing models and standards, the developed model stores contextual knowledge about the entire facility, and not just energy infrastructure, thus enables enhancement of energy management algorithms and allowing for application of dynamic energy efficiency measures.

Keywords: Energy informatics, energy management, facility data model, ontology modelling, energy hub, demand side management, linear programming

Scientific field: Electrical and Computer Engineering

Research area: Computer Engineering and Informatics

UDC number: 621.3

Softverski sistem za više-kriterijumsko planiranje i upravljanje hibridnom mikro-mrežom

Sažetak

Efikasno upravljanje energetsom infrastrukturom u kontekstu sve većeg udela distribuiranih resursa i obnovljivih izvora energije u kombinaciji sa skladištima energije postaje sve veći izazov. Kada se još ima u vidu da su ovakvi hibridni sistemi sve češće povezani na distributivnu mrežu i da funkcionišu u kontekstu liberalnog tržišta energije, postaje jasno zašto postojeći sistemi za upravljanje imaju sve više problema da ostvare efikasan rad. Ova složenost upravljanja takođe otežava i bržu penetraciju obnovljivih izvora i doprinosi nepredvidivosti po pitanju njihove ekonomičnosti. Ova teza predlaže inovativni softverski sistem koji donosi napredne algoritme za planiranje i upravljanje hibridnim mikro-mrežama, pri čemu se oslanja na postojeće sisteme nadzora upravljanja za potrebe prikupljanja podataka i neophodnih informacija sa fizičkog sloja, ali i za prosleđivanje i sprovođenje donesene kontrolne akcije. Imajući u vidu ovu vrstu zavisnosti od postojećih sistema, jedan od doprinosa teze je bio upravo razvoj inovativnog pristupa za jednostavnu integraciju sa postojećim IKT sistemima koji često koriste posebne, nestandardne, protokole i mehanizme za komunikaciju. S tim u vezi, predloženo rešenje prevazilazi potrebe za komunikacionom i semantičkom interoperabilnosti i otvara prostor za napredno rezonovanje. U nastavku je dat kratak pregled konkretnih rezultata kao i osnovnih doprinosa u odnosu na postojeća rešenja. Pre svega, razvijen je alat za planiranje, odnosno dizajn, mikro-mreže koji slično postojećim pristupima razmatra hibridne energetske infrastrukture sa konvencionalnim i obnovljivim izvorima energije, različitim elementima za konverziju kao i skladištima energije putem odgovarajućih matematičkih modela različite kompleksnosti. Međutim, predložena metodologija unapređuje postojeće alate i pristupe u planiranju kroz integralno razmatranje domena električne i toplotne energije, razmatranja kako izolovanih sistema tako i onih povezanih na distributivnu mrežu, ali pre svega, primenom fleksibilnosti na strani potrošnje za optimalno dimenzionisanje elemenata mikro-mreže. Pored toga, za potrebe rangiranja višestrukog broja prihvatljivih alternativa, korišćeni su posebni algoritmi za višekriterijumsko odlučivanje. Takođe, razvijen je inovativni model potrošnje koji ima zadatak da utvrdi očekivani profila potrošnje energije. Predloženi model se ne naslanja

na uobičajene modele koji se zasnivaju na fizičkom modelu zgrade već se uvodi metodologiju koja polazi od navika i zahteva samog korisnika kao i postojećih potrošača.

U okviru teze, razvijen je i alat za upravljanje mikro-mrežom koji ima za cilj nadogradnju postojećih sistema za upravljanje. Naime, razvijeni alat je testiran u realnom okruženju gde je ostvario prosečne uštede troškova reda 10% kroz jednostavnu, softversku, nadgradnju postojeće upravljačke infrastrukture. Dobijeni rezultati su potpuno uporedivi sa onima koji se dobijaju prilikom neuporedivo većih investicija koje se tiču zamene pojedinih uređaja za neke efikasnije. Predložena metodologija, koja je implementirana u okviru ovog alata, se konceptualno oslanja na neke od postojećih pristupa ali pravi kvalitativni pomak u odnosu na njih jer uvodi u razmatranje upravljanje potrošnjom, i to na nivou pojedinačnih uređaja, što dalje omogućuje direktnu primenu rezultata optimizacije na odgovarajuće kontrolne akcije, što nije slučaj sa postojećim metodama. Konačno, u okviru teze je razvijen i model kompleksnih objekata i njihove odgovarajuće energetske infrastrukture kao i unificirani model za komunikaciju kako bi se omogućila semantička interoperabilnost postojećih nadzornih i kontrolnih sistema koji često koriste posebne, nestandardne, komunikacijske protokole. Korišćenjem tehnologija semantičkog veća i polazeći od već postojećih modela i standarda, razvijeni model služi kao baza znanje o čitavom sistemu, a ne samo energetskej infrastrukturi, čime se omogućava unapređenje algoritama za upravljanje energijom i omogućava primena dinamičkih mera energetske efikasnosti.

Ključne reči: Energetska informatika, upravljanje energijom, modelovanje energetske infrastrukture, modelovanje na bazi ontologija, energetske hab, upravljanje potrošnjom, linearno programiranje

Naučna oblast: Elektrotehnika i računarstvo

Uža naučna oblast: Računarska tehnika i informatika

UDK broj: 621.3

Table of contents

| | |
|--|-----------|
| 1. Introduction | 1 |
| 1.1. Research focus, objectives and relevance | 2 |
| 1.2. Research methods | 5 |
| 1.3. Achieved scientific results | 7 |
| 1.4. Organization of the thesis | 8 |
| 2. Proposed system architecture and development methodology | 10 |
| 2.1. Adopted architecture design methodology | 12 |
| 2.2. Reference projects and architectures | 13 |
| 2.3. Proposed system architecture and system components | 14 |
| 2.3.1. Energy resources layer | 19 |
| 2.3.2. Energy Gateway Layer | 21 |
| 2.3.3. Service / Middleware Layer | 23 |
| 2.3.4. Energy Management Applications Layer | 24 |
| 2.4. Integration and semantic interoperability approach..... | 29 |
| 2.4.1. Semantics-based collaboration framework..... | 29 |
| 2.4.2. Integration approach..... | 30 |
| 3. Knowledge repository and semantic integration layer | 39 |
| 3.1. Overview of the state of the art approaches..... | 39 |
| 3.2. Ontology engineering methodology | 43 |
| 3.2.1. Core facility ontology | 44 |
| 3.2.2. Compliance with modelling standards | 45 |
| 3.2.3. Facility modelling approach..... | 46 |
| 3.3. Ontology as integration layer..... | 50 |
| 3.4. Software implementation..... | 54 |
| 3.4.1. Ontology development and instantiation..... | 54 |

| | |
|--|------------|
| 3.4.2. Interfacing with Ontology | 56 |
| 4. Scheduling service for optimized operation of hybrid microgrid..... | 61 |
| 4.1. Overview of the state-of the art approaches | 61 |
| 4.2. Proposed methodology for integrated optimization..... | 64 |
| 4.3. Modelling and optimisation framework..... | 68 |
| 4.3.1. Infrastructure modelling | 68 |
| 4.3.2. RET modelling | 75 |
| 4.4. Software implementation..... | 93 |
| 4.4.1. Prototype development..... | 93 |
| 4.4.2. Software application..... | 95 |
| 4.4.3. Integration and deployment within μ GM system..... | 99 |
| 5. Planning service for multi-criteria design/retrofit of hybrid microgrid | 103 |
| 5.1. Overview of the state of the art approaches..... | 104 |
| 5.1.1. Energy planning tools and approaches | 104 |
| 5.1.2. Demand modelling | 107 |
| 5.2. Proposed methodology | 109 |
| 5.2.1. Multi-criteria microgrid design | 109 |
| 5.2.2. Energy demand modelling approach..... | 127 |
| 5.3. Software implementation..... | 133 |
| 6. Application of proposed solution and impact validation..... | 137 |
| 6.1. Semantic integration of legacy EMS with advanced energy services at Malpensa and Fiumicino airports..... | 137 |
| 6.1.1. Airport ontology population | 138 |
| 6.1.2. Ontology API parameters | 141 |
| 6.1.3. Energy saving messages | 142 |
| 6.1.4. Ontology validation considerations | 143 |

| | |
|--|------------|
| 6.2. Improved operation of IMP energy infrastructure | 146 |
| 6.2.1. Physical Layout and Use Case Description..... | 146 |
| 6.2.2. Infrastructure modelling | 149 |
| 6.2.3. Numerical Simulation..... | 149 |
| 6.2.4. Optimisation results..... | 153 |
| 7. Conclusions and future work | 159 |
| 7.1. Discussion on achieved results | 159 |
| 7.2. Future work..... | 161 |
| Literature | 165 |
| Appendices | 183 |
| Appendix I: Ontology API for local access | 183 |
| Appendix II: Ontology API for remote access | 184 |
| Author biography | 185 |

1. Introduction

Aiming at reducing greenhouse gas emissions, a huge number of countries ratified the Kyoto protocol¹, which was transposed afterwards into national energy laws, directives and policies. At the same time, due to the unprecedented growth of the cities, the role of electricity, as an energy carrier, is increasing, while the construction of new transmission lines and large central power plants becomes more and more difficult and expensive. Consequently, the energy directives and policies all around the world promote distributed generation (DG), renewable energy technologies (RET) and energy efficiency (EE) in order to reduce greenhouse gases (GHG) emissions, central energy production and transmission costs, as well as dependency on imported fossil fuels. Moreover, nowadays, not only that the various sorts of incentives exist (feed-in tariffs, environmental taxes, to mention a few), helping RET to reach the grid parity more quickly in high-cost retail electricity markets, but also the prices of RET equipment are dropping, especially regarding solar photovoltaic panels and small wind turbines. As a result, in the case of electricity, a global transition from the conventional power grid towards a so-called “smart” grid, featuring high levels of DG, RETs and energy storages together with intelligent management and control systems, is currently ongoing. In other words, future energy systems will therefore increasingly combine the features borne by typically large, dispatchable and conventional energy sources with those of relatively small and intermittent renewables. Planning and running the overall system in the most effective way has thus become an issue of increasing importance, since it features units with both complementary and conflicting characteristics. This is furthermore relevant not only at the grid level, within the domain of transmission and distribution system operators (TSO/DSO), but also on the scale of industrial, commercial and even residential installations. Such issues are additionally complicated by the fact that energy networks for different carriers (e.g. electricity and gas) will foreseeably be more closely interconnected in the future due to the presence of novel conversion units, and storage devices will also be commonly deployed and operated.

Following the very nature of the distributed generation, the monolith conventional energy systems are increasingly being clustered to much smaller, independently managed, grids

¹ the Kyoto protocol, https://en.wikipedia.org/wiki/Kyoto_Protocol

called the microgrids. Typically, they are featured by their on-site generation, often mixing different types of renewable energy, and thus referred to as “hybrid microgrids”, local demand and optional storage capacity. Although being often physically a part of the larger energy network, they are typically connected with the rest of network through a single connection point and are operated independently, following their own decision criteria. As a result, power grid “sees” the microgrid as a single prosumer (producer and consumer) with aggregated demand, available storage capacity and local production. Moreover, the grid delegates all control and management responsibilities behind the connection point, which then simplifies overall grid coordination and management. In return, microgrid management is able to operate independently local production and available storages to satisfy local demand, store energy or export it to the rest of the grid, typically following the economic option. Moreover, depending on the size, a microgrid can participate in the wholesale markets, instead of retail ones, and negotiate much better import/export energy prices. In addition, it can leverage local production and storage capabilities to curtail and/or flatten its aggregated demand, which can further bring down import energy prices.

Although the microgrid concept exists for a long time, it was initially applied to small, isolated (island), installations where variable renewable energy (VRE) were typically combined with dispatchable generators, running on fossil fuels. In such installations, the cost effectiveness of VRE is irrelevant, and even hard to estimate, as there is no alternative grid supply, nor the option to export energy, while fossil fuels are used merely as backup, which made it quite straightforward to manage. However, with the increased penetration levels of VRE in urban environments, the problem of planning and operation of a grid-connected microgrid became non-trivial. Given the stochastic nature of VRE combined with electric and thermal storage capabilities, dynamic energy import and export pricing and flexibility on demand side, makes it a complex problem in general.

1.1. Research focus, objectives and relevance

The subject of the proposed thesis is about developing a software system for optimal multi-criteria planning and management of energy infrastructures with multiple types of conventional and renewable sources, flexible control options and operating in a complex context of deregulated energy market. Current global trends in energy policy are mostly

associated with the long-term environmental and economic sustainability of energy supply and, therefore, they stipulate development and utilization of environmental friendly energy-sourcing technologies as well as innovative energy management systems able to cope with existing energy infrastructures and the future, so called, “smart” grids. In other words, the focus is made on the increasing use of renewable energy technologies and distributed generation, as well as intelligent management and control systems that can lead to increased energy efficiency, decreased operational costs and contribute to overall grid stability. Considering the above mentioned, the energy systems of the future will undoubtedly combine controllable high-power energy sources (e.g. conventional thermal power plants) with relatively unpredictable renewable energy sources of significantly lower capacity. Therefore, the efficient planning and management of such heterogeneous and complex systems, which is often driven by adversarial decision criteria, becomes a challenge of increasing importance which affects not only the domain of transmission and distribution system operators (TSO/DSO) but becomes more and more present at the level of industrial/commercial and residential micro hybrid power plants. Additionally, the challenge of the efficient energy management will be further aggravated by considering increasing presence of distributed energy storages, as well as the fact that distribution networks of different energy carriers (e.g. electricity and gas) will be even more interconnected in the future by means of energy conversion devices, such as combined heat and power (CHP) plants and heat pumps. In order to contribute to solution of aforementioned challenges, this thesis will primarily be focused on research and development of ICT enabled innovative paradigms for a) optimal planning and management of energy resources within hybrid microgrids, with both renewable and conventional energy sources and b) overcoming the semantic interoperability challenges that hinder the deployment of innovative management approaches in the context of heterogeneous, legacy, supervision and control systems. The objective was therefore to develop necessary underlying methodologies, models and concrete software artefacts that will be able to provide advanced energy management services by the extending existing building and energy management systems (SCADA/BMS/EMS) in seamless and non-invasive way. In other words, the objective was to complement the existing SCADA/BMS/EMS functionalities by introducing innovative software layer offering

advanced energy management applications over existing physical supervision and control infrastructure.

When it comes to planning of hybrid microgrids, the objective was to develop a software tool serving as a decision support system for optimal RET and DR deployment, in case of both retrofit and newly designed energy infrastructures. The aim was to take into account all relevant factors for RET and DR deployment such as geographical location, energy demand requirements, spatial availability, applicable energy pricing schemes and governmental subsidies (e.g. feed-in-tariffs), available governmental incentives etc. Moreover, the goal of the underlying planning methodology was to take into consideration a number of technical, economic and ecological evaluation criteria and to assess them simultaneously. In this regard, it was required to develop a detailed, parameterized, simulation environment, which offers long-term simulation and optimization of operation of energy systems with different renewable energy sources satisfying both electrical and thermal energy demand.

Moreover, the simulation environment had also to consider different energy storage options as well as connection and exchanges with the power grid. Apart from estimating energy harvesting potential from RET through modelling and simulation, the goal was also to account for an innovative data-driven energy demand model that leverages information about historical consumption, existing appliances and user habits rather than building physics and first principle models, which was a common approach so far. Finally, by accounting for all aforementioned factors, the overarching objective of the developed planning tool was to deliver optimal microgrid topology, together with accurate dimensioning/sizing of individual renewable energy sources and storages.

When it comes to management and operation of hybrid microgrids featuring different conventional and renewable energy sources, the objective was to improve the existing high-level process supervisory management systems. The intention was to develop an innovative software layer that would enable optimal day-to-day scheduling and management of on-site energy generation, energy imports and exports to a power grid as well as available energy storages by taking into account variable import and export energy prices for each carrier, conversion efficiency for dedicated energy infrastructure, state of charge of energy storages etc.

To enable effective deployment of the planning and management/ scheduling application, part of the performed research was focused on the development of an innovative metadata layer, leveraged by the semantic model of complex infrastructures, which enables seamless integration and semantic interoperability with any existing, legacy, information system. Moreover, by benefiting the contextual knowledge about the entire system and reasoning upon it, a potential for development of innovative system functions leading to increase of overall energy efficiency was unlocked.

1.2. Research methods

To ensure real life applicability and demonstration of the proposed solution, the concrete, innovative, software artefacts presented in this thesis were developed as a part of the larger, complex, ICT system referred to as Microgrid Manager (μ GM) in the following. As stated, the μ GM was designed as an extension to the existing SCADA and BMS/EMS, aiming to provide advanced energy management related services. This comprehensive service-oriented software system comprises a wide range of data and information sources connected via software-based communication gateways, which enable both data and information retrieval as well as forwarding of control actions, to enable application of its advanced energy management services. In other words, μ GM covers aspects ranging from access to different physical sensors and meters, translation of their communication protocols to a common language, storage of collected data in a system database and knowledge repository, development of advance energy management services, reasoning on top of collected data and third-party services and, finally, building the appropriate interfaces towards users.

The work presented in this thesis was devoted to development of the core μ GM energy management services and possible solution for the semantic interoperability challenges prompted by the legacy information systems. To provide the necessary context for the developments presented in this thesis, the overall μ GM system architecture is elaborated while the focus was made only on the specific aspects of such complex system where a clear scientific contribution and progress beyond the state of the art was made.

By assessing different software layers of the μ GM system, an overview of research methods and technologies used to deliver the aforementioned scientific contributions is following. Wherever possible, the open-source solutions were preferred. Starting from

the microgrid planning and management, they were developed as two independent high-level applications, sharing a common optimization engine for simulation and optimization of multi-carrier energy infrastructure operation. For the purpose of development of such engine, the two approaches were considered. In case of linear problem formulations, both linear and integer programming algorithms were used, whereas in the case when the desired formulations featured nonlinearity, the evolutionary algorithms were considered, namely the Genetic Algorithm (GA). In either case, the problem formulation involved manipulation with extremely large but sparse matrices ($\sim 10^6 \times 10^6$). The initial prototype and proof of concept was developed in the Matlab/Simulink environment, while it was subsequently developed as pure Java application, offering core business logic. The use of sparse matrices for problem formulation in Java was enabled by a suitable library for linear algebra (La4J, Colt, Commons math etc.). When it comes to the actual optimization routines the industry standard IBM's optimizer CPLEX was employed for both linear and mixed integer problems, owing to its high performance. The multi-criteria decision making (MCDM) algorithm used for microgrid planning was implemented on the basis of the Promethee II algorithm. Also, for the purpose of a user friendly GUI development, several open-source technologies such Java, Java Server Faces, Java Script, Ajax and other were employed. Finally, the application was deployed on a Tomcat server with a MySQL database. Given the service-oriented nature of the overall system, a communication middleware infrastructure was set-up to connect data/information sources with services carrying the core business logic, as well as appropriate interfacing with the end user. The system considers a wide range of data/information sources such as IoT enabled sensing equipment, conventional meters (using protocols such as ModBus, BACNet, DLMS, IEC 60870/61850 etc.), third party data sources (meteorological service, energy pricing service etc.). For the purpose of such middleware a standard and robust solution of Enterprise Service Bus was considered (the WSO2 implementation) in parallel to a lightweight MQTT broker (Eclipse Mosquitto). When it comes to the development of the semantic model, the existing CIM standard (Common Information Model - part IEC 61970), the generic SUMO ontology (Suggested Upper Merged Ontology) and the domain ontology IFC (Industry Foundation Classes) were used. Finally, for the development of ontology and class hierarchy, the open source tool Protégé was used. To automate the process of extraction of large amounts of data stored in files

and tables and use this data to instantiate the ontology tools like OpenRefine and TopBraid with SPIN add-on were used in combination with SPARQL Update queries.

1.3. Achieved scientific results

As stated, the overall result of the proposed thesis is a software system for multi-criteria planning and optimal management of complex energy infrastructures, i.e. microgrids, with multiple types of conventional and renewable energy sources, converters and storages, operating in a dynamic context of a deregulated energy market. A breakdown of concrete results and outputs is following, with the emphasis on their specific advancements compared to the existing approaches:

1. Multi-criteria microgrid planning tool for optimal design, or retrofit, of hybrid energy infrastructures with both conventional and renewable energy sources, converters and storages used to satisfy both electrical and thermal demand under variable energy pricing scheme. The tool leverages hourly based mathematical models of energy assets, novel approach for demand modelling and elaborate energy pricing approach, to perform long-term feasibility assessment through joint simulation and optimization. The underlying design methodology advances the existing tools and approaches by simultaneously considering both electric and thermal energy domain, by considering both grid-tied and isolated deployment scenarios, by leveraging demand side flexibility for optimized component sizing and by providing multi-criteria assessment over multiple technological, economic and environmental criteria. The initial results were published by the candidate in a peer-reviewed conference [1] and currently a journal contribution is under preparation.
2. Microgrid management tool for day-to-day scheduling of energy assets within a multi-carrier hybrid energy infrastructure with distributed generation, converters and storages. It features comprehensive optimization of multiple energy flows from on-site generation, imports from the supply networks, available storage capacities and required energy demand under the dynamic context of deregulated energy market. The underlying methodology complements the existing approaches by introducing demand response schemes for enhanced optimization of microgrid operation. The proposed methodology features modelling of appliance-level demand response actions which complements the existing approaches by allowing for immediate

application of optimization results into real-world control actions. The results were published by the candidate in a journal paper [2].

3. Ontology-based facility model of complex facilities and corresponding energy infrastructure. By employing semantic web technologies and leveraging existing models and standards, the developed model stores contextual knowledge about the entire facility and not just energy infrastructure. As a result, it enables enhancement of energy management algorithms and allows for application of dynamic energy efficiency measures. Moreover, it enables semantic interoperability of existing diverse, legacy, supervision and control systems, which use proprietary communication protocols. The results were published by the candidate in a journal paper [3].
4. Energy demand modelling tool used to determine demand profile suitable for utilization by energy planning tools. Rather than employing common building physics approaches, the underlying methodology leverages user habits and behaviour together with the existing energy infrastructure characteristics. Moreover, it uses previous energy costs to calibrate to model. The proposed approach is flexible and scalable enough to support demand modelling on larger scale such as neighbourhoods and districts as well as applicable to other utilities, such as water. The results were published by the candidate in a journal paper [4].

1.4. Organization of the thesis

The remaining of the thesis is organized as follows. The Section 2 introduces overall μ GM system architecture and development methodology. It starts with the introductory architecture definition methodology and overview of reference projects and architectures. Then, it elaborates on the proposed architecture and system components clustered among the four main layers: energy resources layer, energy gateway layer, service/middleware layer and energy management applications layer. Finally, the section is concluded by the employed integration and semantic interoperability approach. The next is Section 3, which elaborates on the system knowledge repository and semantic integration layer. It starts with an overview of the state of the art approaches and introduces ontology-based knowledge modelling. The following subsection deals with ontology engineering methodology by discussing the core facility ontology, compliance with modelling standards and facility modelling approach. The advantages of ontology as integration

layer are presented before the details about software implementation are disclosed. The latter entails details about ontology development and instantiation as well as interfacing options for the system components. The following Section 4 deals with scheduling service for optimized operation of hybrid microgrid. Moreover, it focuses on the underlying optimization engine. It begins with an overview of relevant existing approaches and continues with the proposed methodology for integrated microgrid operation optimization. The modelling and optimization framework was elaborated in the following, by distinguishing modelling of energy infrastructure and renewable energy sources and storages. The section is concluded with disclosure of software implementation details featuring prototype development, software application development and its integration with the rest of the system. Section 5 discusses energy planning service for multi-criteria design and retrofit of hybrid microgrids. A detailed overview of existing approaches dealing with similar planning problems is provided. Moreover, a brief consideration on existing demand modelling approaches is provided. The proposed methodology for multi-criteria microgrid design and description of proposed energy demand modelling approach is following. The section is concluded with the software implementation details related to this service. Finally, the application of proposed solutions and their impact validation is provided in the Section 6. It starts with the demonstration of semantic integration at Malpensa and Fiumicino airports, the two illustrative examples where some of the above mentioned innovative energy management procedures were introduced as a part of the EU FP7 project CASCADE. Subsequently, airport ontology population is described, followed by definition of the ontology API parameters and energy saving messages. Lastly, considerations about ontology validation are provided, followed by the demonstration of application of scheduling service for improved operation of energy infrastructure at the Institute Mihajlo Pupin's multi-carrier environment, featuring proprietary rooftop grid-connected photovoltaic plant and fossil fuel-powered thermal plant next to its connection to the distribution network. Starting with physical layout and use case description, concrete infrastructure modelling is presented and, subsequently the results from numerical simulation and optimization are presented. Finally, the thesis is concluded with the Section 7 where the discussion on achieved results is provided along with the outline of the future work and research focus.

2. Proposed system architecture and development methodology

This section identifies and specifies the overall system architecture, individual modules and interoperability interfaces, enabling and composing energy management services, including the innovative ones, which are the subject of this work. The following architectural description will provide reference principles, guidelines and recommended specifications for each macro-function, as well as selection of specific design patterns guiding the integration of middleware services. In particular, Reference Model of Open Distributed Processing² (RM-ODP) specification of the enterprise, computational and information viewpoints will be provided. Such viewpoints will encompass the design of monitoring and control systems inside and outside the target infrastructure, addressing the organization of legacy and new ICT components, the definition of a communication infrastructure and the identification of energy management applications. Although the framework for developments in this thesis was limited to a single building/organization/entity, it is generic and scalable enough, so that it can easily accommodate the future energy management systems, which will encompass clusters of buildings at a district/neighbourhood level.

Moreover, this section elaborates on the chosen integration approach and semantic interoperability methodology. It gives the necessary context for a better understanding of the ontology-based facility data model within the broader socio-technical system. The method proposed addresses the need for systematic procedures aligned with the recent Maturity Models for Energy Management [7], [8]. These conceptual tools provide high-level guidelines that need to be further developed into the activities and technologies applicable at the lower level [7]. The activities involved in its practical implementation rely on the appropriate management of a plethora of diverse and unstructured data sources. Therefore, the recent advancements in data management field, such as ontology-based data repositories/models, provide a unifying metadata layer facilitating more informed energy management decisions and will play an important role in achieving full maturity and widespread adoption of standardized energy management practices.

² RM-ODP, ITU-T Rec. X.901-X.904 | ISO/IEC 10746, [link](#)

Furthermore, in some cases, the data and information management capabilities of contemporary energy management and diagnostics software packages emphasize data and framework interoperability as solely justifying a cost effective investment [9]. Requirements gathered during the initial stage of the presented research established the need for a technological solution with high scalability and replicability potential [10]. A structured approach that supports modularity and flexibility is required to optimize ICT related costs and deployment times across a diversity of facilities' sizes, existing energy systems, locations, often governed by different organizational structures. The three main drivers have been identified as challenges to the proposed methodology, which derived from the commonly known barriers to ICT renovation of inherent complexity, unforeseeable requirements and perpetual change [11]:

Increasing complexity of information/data sources. Complex energy infrastructures require deployment, operation and maintenance of diverse supervision and control systems, namely the heterogeneous ICT assets, which generate disparate and unconnected information and data sets. As a result, a variety of field level protocols such as DLMS, ModBus, BACnet, CAN or KNX/EIB impose a lock-in barrier to developing a comprehensive data integration solution. This problem has been addressed in the presented research by adopting a multi-paradigm service oriented architecture (SOA) framework, where loosely coupled systems interact committing to a set of business rules and data transformation rules, using a unified messaging format over flexible file formats such as XML or JSON. In addition, an ontology metadata layer was chosen to support the integration, enrichment and semantic interoperability of the mentioned fragmented data structure.

Energy management readiness of legacy systems. Data generated by existing BMS/EMS's is often insufficient or incomplete to allow for advanced energy management analysis. These technologies are designed to monitor real-time variables at several system points and facilitate remote operational control of settings, such as schedules or set points. Implementing energy management software that uses advanced optimisation algorithms requires careful consideration regarding available data, their quality, actuating capabilities and other characteristics.

Considering interaction of human and physical systems. Complex infrastructures are operated according to demanding standards driven by legislative obligations or strategic sustainability programmes. Systems operation is influenced by the organizational style and subjected to the existing contractual arrangements affecting operations and maintenance (O&M) day-to-day practices. Moreover, expertise of energy management in practice is often buried in arcane knowledge and sometimes locked by facility management companies. Introducing new standards, like the ISO 50001 Energy Management [12], represents an opportunity to build a common pool of engineering expertise within an organization, and to minimize misinterpretation of common principles [14].

2.1. Adopted architecture design methodology

The adopted methodological process employed for system architecture design was the RM-ODP, also named ISO/IEC 10746 and ITU-T Rec. X.901-X.904, which derived from a joint effort by the International Organization for Standardization (ISO), the International Electrotechnical Commission (IEC) and the Telecommunication Standardization Sector of the International Telecommunication Union (ITU-T). RM-ODP aims at providing coordination framework for the standardization of open distributed processing (ODP), supporting distribution and collaboration platform, technology independence and portability, together with an enterprise architecture framework for the specification of ODP systems.

RM-ODP allows collaborative creation of design artefacts, following the principles of interoperability, modularity and reusability. The RM-ODP family of recommendations and international standards defines essential concepts necessary to specify open distributed processing systems from five prescribed viewpoints, depicted in Figure 1, and provides a well-developed framework for the structuring of specifications for large-scale, distributed systems. More specifically, the RM-ODP framework provides five generic and complementary viewpoints on the system and its environment:

- The enterprise viewpoint, which focuses on the purpose, scope and policies for the system. It describes the business requirements and how to meet them.

- The information viewpoint, which focuses on the semantics of the information and the performed information processing. It describes the information managed by the system and the structure and content type of the supporting data.
- The computational viewpoint, which enables distribution through functional decomposition of the system into objects, which interact via interfaces. It describes the overall functionality provided by the system and its functional decomposition.
- The engineering viewpoint, which focuses on the mechanisms and functions required to support distributed interactions between objects in the system. It describes the distribution of processing performed by the system to manage the information and provide the required functionality.
- The technology viewpoint, which focuses on the choice of technology to implement the system. It describes the technologies chosen to provide the processing, functionality and presentation of information.

2.2. Reference projects and architectures

The focus of the conducted research is on selection of the appropriate system architecture and corresponding deployment model, given the requirement to integrate heterogeneous hardware and software components devoted to energy monitoring and control at building/household level. The problem has been known and investigated for several years and the existing literature has emphasized that the complexity of this integration is severely dependent on the number of different devices employed, existing on-site energy generation and storage, legacy software systems, etc. In principle, the most widely acknowledged solutions referred to the use of data-unifying layer for tackling this problem. This layer focuses on abstraction of the complexity of lower components of facility and aims to solve the interoperability challenges through unification and conversion of data coming from lower software levels, thus overcoming any format-related issues for pluggable application layers. The following is an overview of different middleware architecture proposals in the context of energy management.

The AIM project [15] presents a framework architecture for modelling, visualizing and managing energy consumption of home appliances. The project proposes development of a gateway which consists of the three separate modules: i) a module providing machine-

to-machine interfaces through a common API for implementation of gateway-related services, ii) an identity management module for user authentication and authorization, and iii) a module for service integration and orchestration, offering also creation of new, composite, services upon such integration.

The HYDRA project [16] brought a generic middleware platform for heterogeneous devices, which facilitated communications between the devices and provided an architectural infrastructure for network abstraction, event management and services communications. It was not built primarily for energy management purposes, however it provided infrastructure for construction of energy-aware solutions.

The LoCal project [17] was undertaken by the research team from the University of California, Berkeley, and delivered an intelligent and autonomous power system for local energy generation, distribution and sharing based on the so-called Intelligent Power Switch (IPS). By complementing the traditional electrical grid, with objective of reducing the grid load, the developed switch standardizes the electrical flow coming from different sources (with different characteristics, e.g., voltage, frequency) and manages communications between the nodes of the grid. The global architecture of the LoCal grid is a distributed architecture following a peer-to-peer communication model. However, the architecture does not include any energy optimization or reduction approaches.

The EPIC-Hub project [18], undertaken, among others, by the Institute Mihajlo Pupin, developed a new methodology, an extended architecture and services able to provide improved energy performances, both on building and neighbourhood level. It leverages upon energy gateways to integrate various data sources in the middleware architecture and offer implementation of advance energy demand and supply optimization services.

2.3. Proposed system architecture and system components

From an architectural perspective, modelling energy facilities sets the design focus onto the definition of energy interfaces. The adopted modelling approach breakdowns all energy systems into conversion units, able to transform different energy supply carriers to a desired demand, energy storage assets and an energy export interface, for exchanges with different energy networks. Moreover, the following description of the proposed system design will elaborate on integration of such model with enumeration and classification of computational systems involved in the energy systems management and

energy information retrieval. From an ICT perspective, the proposed system software components can be classified into the following logical areas:

- Control and data acquisition software
- Gateway applications
- Message broking service layer
- User Interfaces and application level algorithms
- External/Third party services

The proposed reference pattern for the interoperability of logical areas required to implement monitoring, supervision and control of the target energy system and resulting system architecture are elaborated in the following sections.

The starting point for the organization of the components has been the identification of responsibilities within the system's operating framework, contexts of operations required by use scenarios and constraints set by the existing infrastructures, ICT systems and actors. In particular, the system architecture is segmented into the following computational layers where the services are allocated:

- *An Energy Resources Layer.* Such layer represents aggregation of all elements of ICT infrastructure devoted to energy metering, energy systems supervision, control and global management.

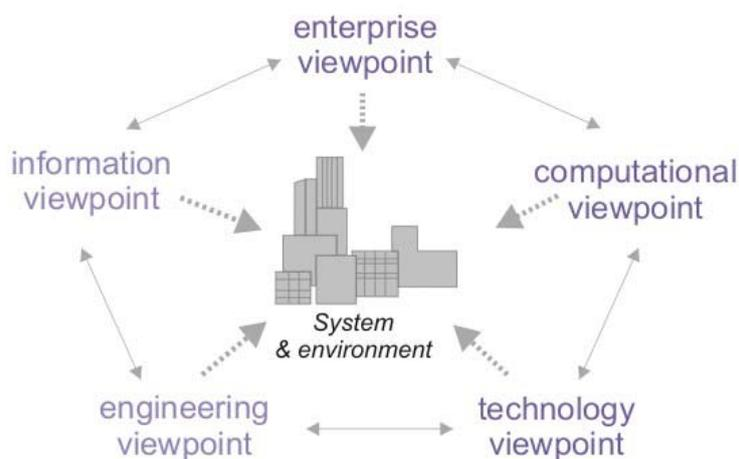

Figure 1: RM-ODP ViewPoint Framework, source: Wikipedia

- *An Energy Gateway Layer.* This layer aggregates all systems devoted to gathering and integration functions of data received by supervision and control systems (e.g. SCADA), Building / Energy Management Systems, Monitoring platforms or even individual Remote Terminal Units (RTUs). The gateways are responsible for the translation of equipment / context specific information into a common, unified open model. They are also responsible for the transmission and execution of commands received from the application / management services.
- *An Energy Service Layer.* Such layer is responsible for all message routing and service orchestration functionalities and also referred to as middleware layer. It provides the required components for connection of management applications, different gateways, as well as any necessary external interface. This middleware implements a modular interface, enabling the scalability of the proposed approach, i.e. it provides connectivity modules allowing the deployment of specific services.
- *An Energy Application and Management Layer.* This layer groups all high level software applications, carrying system's core business logic, like energy dispatch scheduler and energy planning tool, with their corresponding management user interfaces and underlying optimization engines, consumption and demand forecast models, analytical applications etc.

These layers are featured in the proposed system architecture, depicted in Figure 2. This figure represents architectural pattern for deployment in a single entity context, however this approach can easily be extended towards a district/neighbourhood context.

One of the core features of such architectural pattern is the presence of a single, distributed service / middleware layer, which implements message-based communication among all other logical entities, i.e.:

- Multiple instances of facility-located Energy Gateways
- Local and Central applications and Business logic software (planning tool, dispatch scheduler, user interfaces, etc.)
- External Service Providers and the Third Party applications connected through Internet

The main component of this layer is a Messaging routing Bus (e.g. Enterprise Service Bus (ESB) or Message Queuing Telemetry Transport (MQTT) Message Broker) providing an interoperability framework, capable of connecting systems and software applications with different capabilities. This component is also equipped with configurable modules (bundles), devoted to the implementation of specific functionalities and deployed in a distributed fashion.

The list of global features of architecture depicted in Figure 2 is detailed in the following:

Energy resource/systems:

- The replication of energy resource layers indicates the possibility to have multiple instances of BMS/SCADA/Metering systems in case of complex infrastructures / buildings with different systems servicing different topological areas (e.g. airports, exhibition halls etc.)
- Energy resource components' connectivity is characterized by field/industrial bus. Examples of protocols and system-level technologies are depicted in the figure, while more detailed description is provided later on.
- The main information repository for Energy Systems was provided by the data archives and logging applications of BMS/SCADA systems, through loose connection with their persistency databases.

Gateways:

- Gateways connections to ICT/Energy layer are envisioned through custom connectors / industrial protocols
- Gateways classification is made based on their functional scope and their connectivity with the energy systems.
- Simulated data / profiles are implemented at gateway level (i.e. as a specific configuration of existing gateway applications or as dedicated modules). The logical component devoted to data simulation can be the same as the one integrating the output from optimization/planning engines
- Gateway applications perform the transformation, processing and aggregation of data according to the information model specified by the service layer data model

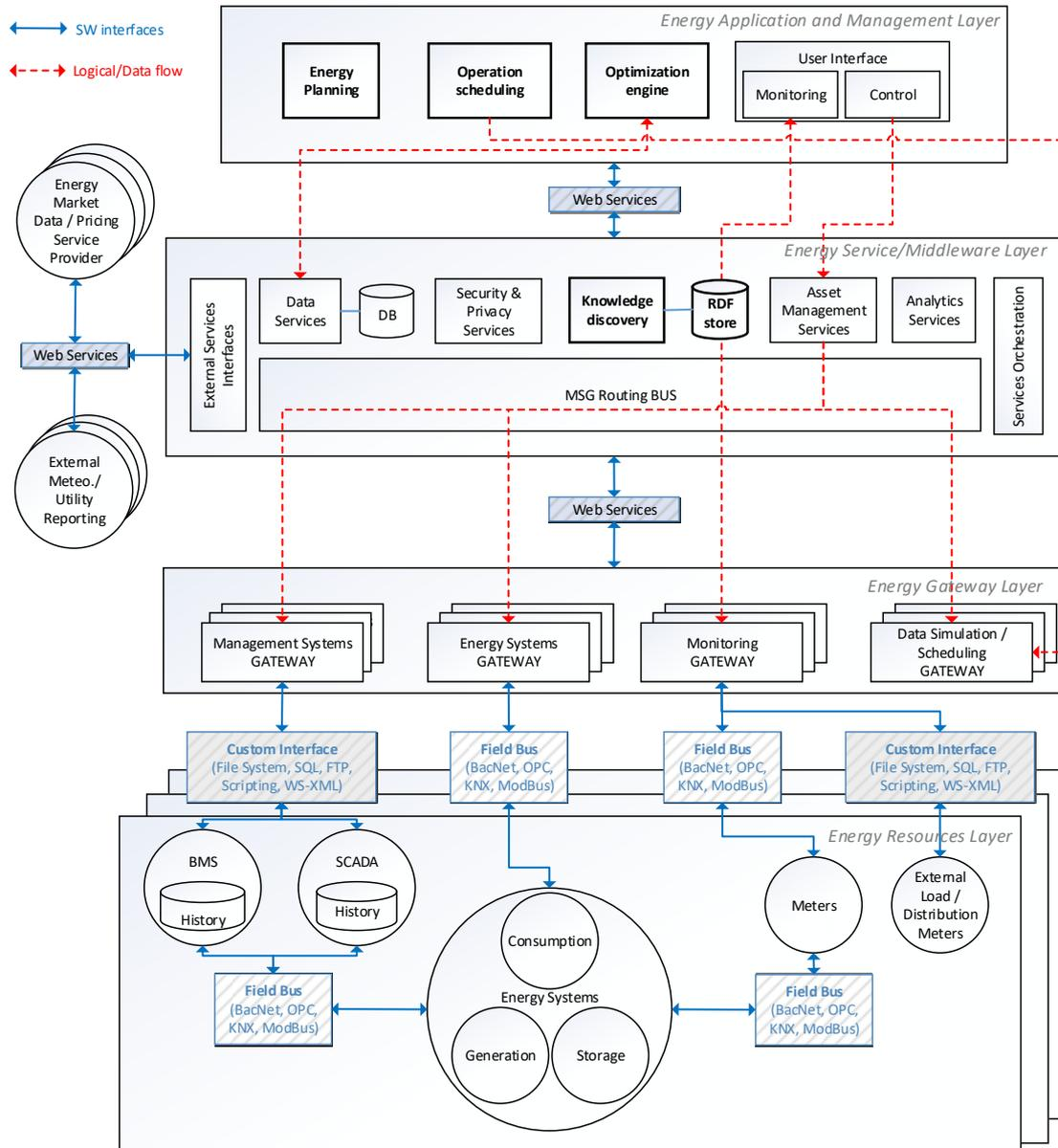

Figure 2: Proposed μ GM system architecture

- Gateway applications expose a common open interface to allow commands issuing, events and data monitoring and general access to the layer below.
- In a scenario where a dedicated BMS system is deployed within a facility, and provides system integration capability, a single gateway may be used, instead of allowing the remote access to BMS functionality from the system middleware.

Middleware:

- Service/middleware layer provides message routing, validation and message transformation functionalities

- It enables interconnection with external services or applications. It can also be used to interface with other instances of the same system deployed in the district/neighbourhood.
- It is responsible for service orchestration and monitoring. It also provides additional support services such as authentication, authorization, information privacy, activity monitoring etc.

Energy Management Applications

- Applications within this layer provide energy management / supervision and control functionalities, which in fact carry the key business logic offered by the proposed system.
- Core applications like Planning and Operation scheduling rely on modules responsible for delivering specific functionality, e.g. optimization engine, energy demand forecaster, local energy production forecaster etc.
- Each module is developed according to an adopted service model and is defined by the inputs it requires and corresponding outputs it offers. For interaction with existing applications, other types of open/loosely connected integration can be defined (i.e. scripting, file system sharing etc.)
- Their integration into a unified workflow, and corresponding sequence of operation, depends on the requirements of specific use-case.

2.3.1. Energy resources layer

Energy resources layer features all devices, pieces of equipment, information systems, automation and control systems, capable of transmitting energy-related monitoring data and/or providing corresponding actuator functionalities over on-site physical systems. In other words, this layer represents a link between μ GM system and the physical world, which entails different energy generation, consumption and storage assets. As depicted in Figure 2, this link may combine two main interface categories to access a range of diverse data sources. The first category represents interfacing with field level devices, such as meters and primary control units, which require utilization of an appropriate field protocol and corresponding field bus. Although there is a large number of industrial standards for field communication, several imposed themselves as being *de facto* dominant and widely

used by the majority of equipment vendors such as DLMS, ModBus, BACnet, CAN or KNX/EIB etc.

The second category represents the case of comprehensive automation and control systems, such as BMS and SCADA systems, which can expose their data, and provide remote interface for their actuators, through appropriate custom interface. Such interface may feature different interfacing technologies and approaches such as File System, SQL, FTP, Scripting or WS-XML. Similarly, data can be extracted from external (e.g. distribution) meters, which typically provide remote access through a custom interface. Being the most complex actor in the energy resources layer, and covering the superset of available monitoring and actuator functions, BMS is briefly elaborated in the following chapter.

Building Management Systems (BMS) refer to a wide range of computerized building control systems, from special-purpose controllers, via standalone remote stations, to larger systems including central computer stations. A BMS usually comprises several subsystems, responsible for operating different parts of building infrastructure such as HVAC systems, electrical systems, lighting systems, fire protection systems, security systems and others. They are typically connected using different field level protocols or custom interfaces. From the proposed system perspective, main functional parts of individual BMS systems are:

- **Remote access interface**, allowing logging into the main BMS environment and accessing individual BMS subsystems, as needed. The interface has to be bi-directional, enabling both information retrieval from BMS (e.g. new or historical data measurements) and sending inputs into BMS, such as explicit set point adjustments or operational targets to be further implemented by the building operator or facility manager.
- **Historical database**, which is usually maintained at the BMS server and contains a variety of data ranging from sensor and meter readings to alarms and specific actions made by human operators. Foreseeably, the proposed system may require access particularly to time series data of meter readings and/or selected sensor measurements, which characterize operation of the main building systems (HVAC), or comfort conditions in interior spaces (temperature, humidity, CO₂ levels, etc.).

- **Network control stations** that serve as the routers or converters to integrate individual field control networks into the higher-level BMS network. Field control networks integrate various automation devices, such as sensors, actuators, and controllers, which are accessible through specific communication protocols. The most commonly used protocols include OPC, BACNet, KNX, ModBus or LON. Such network control stations are foreseen as one of the possible actuators for the proposed system, which uses them to access plant controllers, responsible for operation of the main energy consuming equipment and systems. Depending on specific configuration and capabilities of given BMS, it may be possible either to access these controllers directly through their remote access interface, or there would have to be an internal μ GM-specific executable component / procedure, configured within BMS that would do all required actions without the need to access controllers from outside.

2.3.2. Energy Gateway Layer

The gateway component act as an intermediary between the field level devices existing at a given site, any available supervision and management systems and the μ GM service layer. From an interface perspective, gateway interaction functions are allocated in the two layers: *External* and *Device* layers, depicted in its functional decomposition (Figure 3), briefly elaborated in the following.

The External Layer handles all interactions with application users and system's auxiliary software artefacts and services. Its implementation was based on the use of Web Services (WS), which led to several important implications. WS contributed to improved interoperability, as they enable seamless interaction with other web services or, when needed, may act as a custom interface. They improve reusability and customization of existing interfaces and allow for future extensibility of implemented modules/functions. Finally, they are non-invasive, as they utilize a common technology, which simplifies network and security level configurations and, thus, lower the gateway deployment impact onto existing ICT infrastructure. The specific gateway service calls and their corresponding functions may be split into three main macro-categories:

- **Data input:** depicts service calls accountable for communication with existing Energy Management Systems, Building Automation Systems, SCADA or external meters.

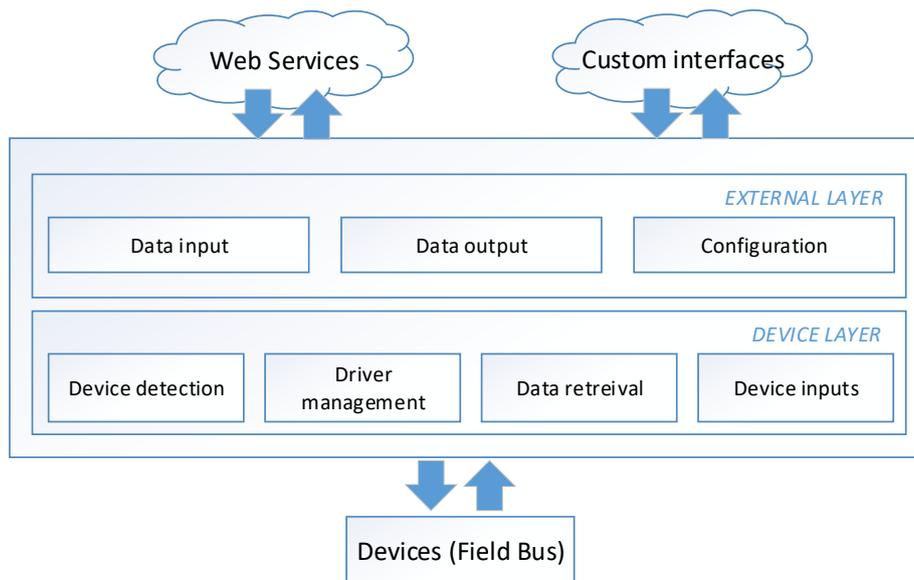

Figure 3: Gateway functional decomposition

- Data output: considers service calls accountable for publishing acquired information to the upper Service Layer.
- Device configuration: represents all service calls devoted to the user-driven integration of information related to devices, drivers and device data.

The Device Layer handles interactions with physical devices via field bus, using the Open Services Gateway Initiative (OSGi) approach, featuring four main functionalities:

- Device detection/discovery: functionality for automatic detection of device connection status to the gateway.
- Driver management: search functionality that enables selection of the most appropriate driver for the connected device, from the stored library of different driver types.
- Data retrieval: functionality for data retrieval from connected devices, enabling different data retrieval depending on the device type and driver.
- Device inputs: functionality for issuing commands, rather than just collecting data, from some device types (actuators).

As commonly known, OSGi represents a framework to use Java in a modular way, enabling the use of so-called *bundles*, or application modules that can be started and stopped independently. The rationale behind the selection of this approach is the

possibility to enable Plug and Play functionality for the low-level devices. OSGi specification already defines two key services, in this regard. The first is *Device Access*, which facilitates coordination of automatic detection and connection of existing devices. The second is UPnP, which specifies how OSGi bundles can be developed to interoperate with Universal Plug and Play (UPnP) devices. Finally, to provide seamless access to low-level devices, appropriate drivers may be retrieved from each vendor and loaded with OSGi. However, the flexibility of adopted approach lies in the possibility to create/configure custom drivers, by defining data and methods for a specific device.

2.3.3. Service / Middleware Layer

From the communication perspective, the main functionalities of the Service Layer are provision of protocol support, message routing, data transformation and event management. However, the key function of this layer is to store and provide access to the contextual knowledge about the system, including both energy related infrastructure, as well as ICT systems dedicated to its supervision and control. The layer is represented as a middleware component comprising different software bundles and interfaces, responsible for communicating all the data generated or consumed by application level modules. The main services provided by this component can be divided into three main categories:

- Energy systems based services: represent all services related to the routing, replication, and publishing of information directly associated with the gateway layer and wrapping of the device data.
- Software based services: comprise support services such as identity services, integrity management, security management, etc.
- Scenario based services: depict services dedicated to the processing of information relevant for the business logic and algorithms specifically designed and/or customized to the domain of interest, such as knowledge discovery service, analytical services, energy policy retrieval etc.

On the functional perspective, the classification of μ GM middleware-enabled services follows the common characterization of Energy Information Systems functionalities [5], as follows:

- Data collection, transmission, storage: represents services gathering data from various, heterogeneous information sources, their filtering and normalization, according to a prescribed common data model, and their appropriate storage.
- Knowledge storage and extraction: represents service responsible for storing the contextual knowledge about the system, as well as services for its retrieval and reasoning upon it.
- Events and alarms: depicts services supporting visualization features, such as device diagnostics, plotting of demand response (DR) events, visualization of faults, etc.
- Data analysis: encompasses various data processing /data mining techniques to retrieve performance metrics and indicators from measurements, as well as advanced analysis, such as forecasting of on-site generation and demand, fault detection and diagnosis (FDD) etc.
- Financial/market data flow: represents analysis of variable energy tariffs from energy market
- Remote control and management: depicts control of field level actuators, based on the outputs form management applications.
- General services: encompass reporting, web based support, remote maintenance features, QoS, identity management services, security services, logging, timing services etc.

An overview of actual services, together with their decomposition, is depicted in Figure 4 and it features the design of layer's computational blocks. Besides service adapters and operational bundles, the service layer shall be equipped with a Message and Service Broker component, depicted also in Figure 4, providing higher-level ESB functionalities, such as event processing capabilities, advanced service monitoring, routing actions and transformation of message formats between services. Given the listed functionalities and the adopted Service Oriented Architecture (SOA) approach, μ GM service layer can be effectively implemented through an Enterprise Service Bus (ESB) deployment pattern.

2.3.4. Energy Management Applications Layer

As previously elaborated, the proposed μ GM system can be logically segmented into four application categories. They are Energy Resources, Energy Gateways, Middleware Services and, finally, Energy Management Applications sitting at the top level. As

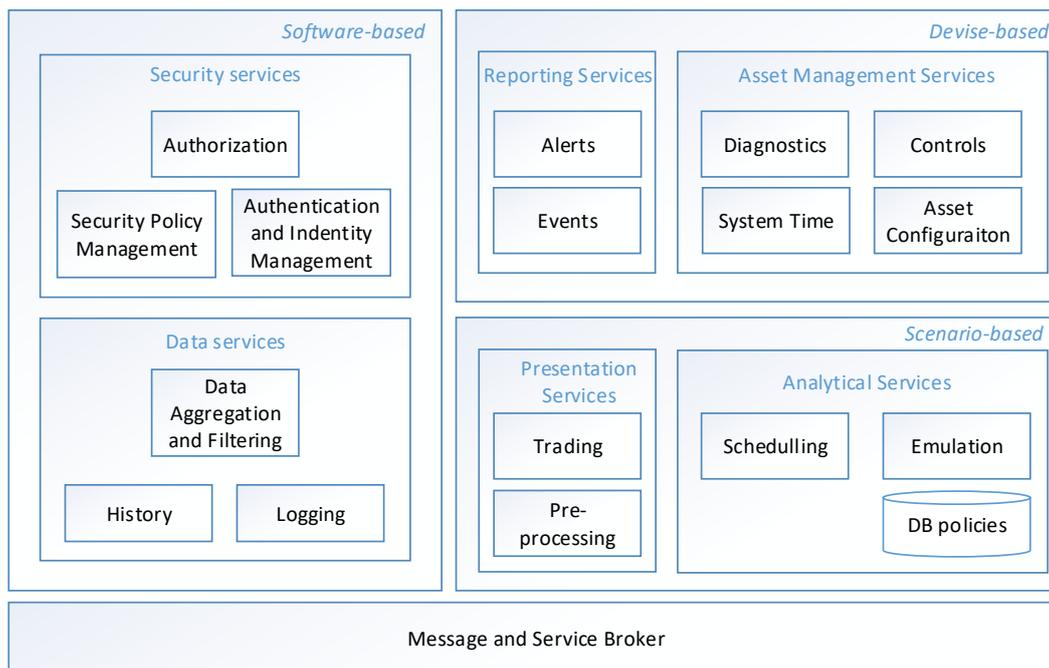

Figure 4: Overview of services at the Service Layer

discussed in the Introduction, the major contribution of this thesis lies exactly in the development of those Energy Management Applications sitting at the top level. From the μ GM end user perspective, User Interface is available only for the Energy Planning and Operation scheduling applications, as they provide high-level management functionalities. However, software realization of those applications requires development and implementation of several logical components depicted in the Figure 5.

The core applications enabling overall system business logic are Optimization engine and Information model.

Optimization engine represents the core system component, offering a generic simulation and optimization framework for complex energy infrastructures. It leverages mathematical representation of those infrastructures, to determine their behaviour against a range of variables (e.g. energy pricing, on-site energy production, energy demand, status of energy storage etc.), parameters (e.g. rated power /

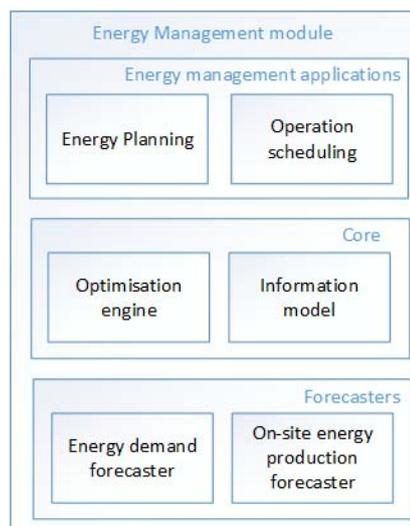

Figure 5: Overview of Energy Management Applications

efficiency / capacity of energy assets) and, user-defined, optimization constraints and objectives over a pre-defined time horizon. For the purpose of energy planning, i.e. design or retrofit of energy infrastructure, the time horizon represents a long-term time interval typically covering a period of one year, in order to account for seasonal variation of all relevant variables. Moreover, in that case usually historical meteorological values are used or, when possible, the so-called typical meteorological year (TMY) data. On the other hand, in case of operation scheduling, the time horizon represents a short-term time interval, typically covering period of several days to adequately schedule operation of critical energy assets.

Information model provides abstract data structures for capturing all context information required for operational optimization of energy infrastructure. This includes: 1) information about technical specification of on-site equipment as well as their interconnections captured by the 2) energy infrastructure topology. The first represents parameters and characteristics for each specific equipment type. Typically, each piece of energy generation equipment has a specified output range, while its performance for different outputs is captured in respective efficiency curve, which can be either gathered from equipment manufacturer or estimated from historical operating data. Other characteristics can include ramp-up and ramp-down rates, start-up costs, normal running costs, or minimum / maximum required up and down times, where up times represent the time interval a unit must be on, when it has been started, and down times denote the shortest time interval a unit must be off when it has been turned off. In addition, most of equipment also has specific requirements on maintenance intervals during their lifetime that must be taken into account by the optimization algorithm. In the case of energy storage devices, they are normally characterized by their maximum storage capacity and by charging and discharging rates. The second represents specification of energy infrastructure topology and information about all importing and exporting energy flows. In other words, it contains information about available energy carriers, existing demand types and interconnection among different energy assets. For example, it comprises information whether a heat pump is connected only to a power supply from grid, or also to an on-site electricity production and/or solar thermal collector (for pre-heating) to satisfy heating demand.

As mentioned, the two most innovative applications, offering interfacing with the system end users are Operation scheduling and Energy Planning applications.

Operation scheduling represents end user application for scheduling of all controllable energy assets in the near future. In particular, it provides decision on energy dispatching from on-site energy production, energy storages and exchanges with the power grid. Moreover, it offers specific device set points, demand curtailment / rescheduling recommendations and appliance switching decisions. When it comes to implementation, this application is, in fact, a wrapper application that performs collection and pre-processing of all inputs necessary to run the Optimization engine and does the post-processing of delivered outputs. Given the fact that operation-scheduling application is used to deliver a future schedule for energy assets, it requires forecast of all relevant variables. In particular, it leverages forecast of on-site energy production, end-user energy demand and energy pricing information, which are transferred as inputs. On the other hand, outputs delivered by the Optimization engine typically require some post-processing, before their delivery to the end user. Namely, this refers to translation of optimization outputs into actionable commands for the existing energy assets.

Energy Planning represents end user application for multi-criteria infrastructure planning, i.e. design and retrofit of energy infrastructure. In particular, it provides decision support to reach an optimal topology and sizing of energy assets for a given context and user defined constraints such as geographical location (yielding energy harvesting potential from renewables), required energy demand, applicable energy pricing schemes, available budget etc. When it comes to implementation, this application is also, in fact, a wrapper application that collects necessary data and forwards it to the Optimization engine. Since that planning application aims at supporting long-term investment decisions for retrofit and/design of new energy infrastructures, the raw output from optimization engine is processed to deliver appropriate technical, environmental and economic performance indicators.

As previously elaborated, the key input for the Operation Scheduling application is prediction of all relevant factors influencing operation of an energy infrastructure. This is responsibility of the forecaster applications, namely the Energy demand forecaster and On-site generation forecaster. Both forecasters are, in fact, heavily dependent on the

weather forecast data and forecast of human activities. However, given the complexity of weather forecast problem and the availability of a wide range of open and reliable forecast services, weather forecast is not implemented as a separate component but rather included as an external service, providing the necessary predictions about weather parameters. It should be highlighted, though, that the imported forecast has to be location specific and with sufficient sampling resolution, typically having one-hour granularity. In case when there is no available weather forecast for a specific location and the local weather exhibits some systematic bias with the regional weather, some sorts of localization techniques are considered. For example, wind velocity has logarithmic dependency on altitude.

Another important aspect for the operation scheduling is the forecast of energy prices applicable for each carrier. Typically, retail energy prices are subjected to a pre-defined scheme that defines several energy zones, to discriminate different amounts of consumed energy, as well as different pricing periods, to account for price intra-day variability. Moreover, the immediate consumed power from the supplier is also taken into account. Therefore, although baseline energy price is in general defined by the contract, the applicable energy price can only be calculated based on the actual demand. Moreover, in cases where energy is purchased from the spot market, the price is retrieved from an external source and due to its volatility, it is hard to deliver a reliable forecast. Having all this in mind, the price forecaster is not considered as another, independent, component, but rather energy pricing scheme is modelled and included within optimization routine.

Energy demand forecaster is responsible for delivering forecast of the two energy demand types, i.e. electricity and thermal demand (cooling, heating and domestic hot water). The key factors influencing these different demands are human activity and comfort requirements. Human activity in buildings is not, in most cases, too much influenced by weather conditions. In case of commercial and industrial buildings, this is usually related to the ongoing operational activity, e.g. manufacturing machines, while for residential buildings the use of home appliances, entertainment electronics and similar is considered. Comfort requirements, on the other hand, are typically represented by standard temperature / humidity ranges. The resulting heating / cooling demand is directly, and mainly, dependent on weather conditions, which yield heat dissipation / heat gains, and occupancy of the building. On the other hand, the thermal demand related to domestic hot water comes completely from human activity. For the implementation

purposes, both deterministic and statistic-based approaches are considered. The latter represents a class of successful forecasters that utilize historical energy demand, together with historical ambient monitoring data, to derive future behaviour from the past data. The forecaster generalizes past situations found in the history database, which stores the most important influencing factors, like weather and occupancy (substituted by daytime and type of the day) and corresponding demand, and estimates future demands from expected future influencing factors.

On-site energy production forecaster is devoted to delivering prediction about local energy generation from renewable energy sources. Although local generation may also come from dispatchable sources, such as diesel generators, combined heat and power plant (CHP) etc., their production is controllable and can be pre-scheduled. Energy production from renewables such as photovoltaic panels, solar thermal collectors and wind turbines is, on the other hand, heavily dependent on weather conditions and their stochastic nature. Therefore, this module also uses weather forecast as the key input. For the implementation purposes, both deterministic and statistic-based approaches are considered. The first one leverages acknowledged mathematical models of renewable energy sources to estimate deterministic behaviour of each renewable source. It can be applied to any energy source, as long as the critical technical information about the device itself is available, i.e. various parameters such as rated power, efficiency dependence etc. The second approach represents any data-driven technique, e.g. machine learning, which leverages measurements from historical operation of specific energy source and former weather conditions combined with forecast of weather conditions to estimate future energy production.

2.4. Integration and semantic interoperability approach

2.4.1. Semantics-based collaboration framework

To provide the desired functionalities and running of aforementioned energy management applications, the proposed system requires intensive information exchanges between the internal components, external data sources and information providers. In the framework of this thesis, development of a conceptual model for interoperability focuses solely to the ICT domain. However, in a broader analysis, different levels of interoperability can be identified, namely:

- *Technical Interoperability*: issues involved in linking ICT systems and services together;
- *Semantic interoperability*: the meaning of information specified in a way understood by all parties (e.g. definitions, relations and structure of terms used to describe data);
- *Organizational interoperability*: coordination of processes in the context where data is used/transformed. (e.g. shared definitions of the roles, responsibilities and interactions of/between participants).

It is also possible to add the *Legal interoperability* to the above levels, which deals with the shared interpretation and understanding of laws regulating information exchange and cooperation. In fact, for the domain of Smart Grid, the GridWise Architecture Council³ (GWAC) defined an eight-layer stack of interoperability categories to provide a context for determining interoperability requirements and defining exchanges of information, depicted in Figure 6.

2.4.2. Integration approach

The μ GM's environment represents, in general case, a complex and heterogeneous environment with a plethora of interacting actors. Operating either at the level of a single building, or several interconnected buildings forming a neighbourhood/district, different ICT systems from multiple vendors are typically deployed. As depicted in Figure 7, typically deployed energy related systems are energy management systems



Figure 6: Interoperability categories, source: GWAC

³ The GridWise Architecture Council, <https://www.gridwiseac.org/>

(EMS/SCADA), building management systems (BMS), distribution management systems (DMS), and sometimes geographical information systems (GIS). These systems often use proprietary formats and legacy communication protocols for the data exchange, often making the communication among the existing ICT

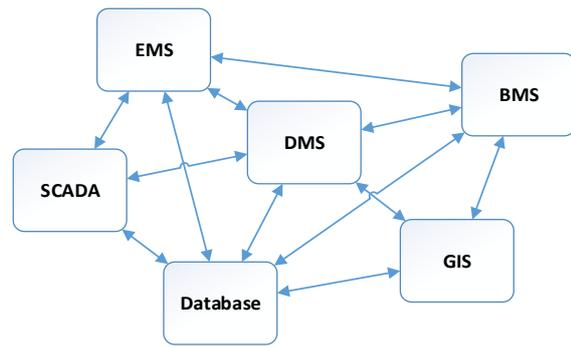

Figure 7: Communication among ICT systems without shared model

systems impracticable. To integrate with such systems, it is necessary to develop custom software adaptors, which thereby create new software layers with a limited set of functions and applicability resulting in yet another closed system, as the one they were built for at the first place. The large number of proprietary formats used by these applications requires several translators to import and export data between multiple systems. This exponential growth in complexity when integrating increasing numbers of applications and exchanging between multiple vendors has driven the requirement for a common format that covers all the areas of data exchange [20].

μ GM's holistic interoperability approach is represented by the two items:

- a semantic item represented by an *Ontology* in OWL (Ontology Web Language) format, and
- a software engineering item (namely a *Class Diagram* in the UML notation) represented by the Canonical Data Model (CDM).

Although being fully interconnected, the development of these information related items is based on two distinct approaches, according to their specific nature. The ontology development process follows a classic *top-down* approach, while the μ GM Canonical Data Model development follows a *bottom-up* approach.

In the case of the top-down approach, the concepts and the semantic relationships in the ontology are typically derived from an analysis and study of relevant information sources about the analysed domains, spanning from energy to construction, passing through building automation and power systems. Since the ontology development process initiates with the definition of the most general concepts in the domain, and subsequently,

continues with the specialization of these concepts in sub-concepts and identification of the semantic relationships (e.g. hyponymy, synonymy, etc.) it is important to reuse existing domain and upper-level ontologies, glossaries and models, identified in the related documentation (e.g. standards, datasheets, relevant documents, papers, etc.)

On the other side, the applied bottom-up approach enabled the development of the CDM as UML Class diagram (Object Oriented approach), which defines the minimum set of business entities relevant for a specific domain, their attributes, operations, and their associations (relationships) [21].

CDM Enterprise Integration Pattern (CDM EIP), defined in [22], is an integration pattern focused on the information-driven integration of multiple IT applications. CDM identifies only those information items that are exchanged and not the internal ones of particular implementations. From this perspective, the approach is bottom-up, since it starts from the existing data structures of the applications to be integrated and it is developed incrementally to cover all the business needs according to [23].

Therefore, overall objectives of the μ GM information model are summarized as follows:

- Formalized and unambiguous knowledge about the μ GM domain
- Complete identification of concepts representing the relevant information entities
- Modelling of all the semantic relationships connecting the identified classes / concepts
- Terminology is common and shared among the involved actors (coming from the interested domains) and only one semantic interpretation (meaning) of the identified concepts exists in the domain
- Clear mappings between raw datasets and their metadata and the ontology concepts, attributes, and predicates.
- All the technical systems are interoperable in terms of exchanged data and resources.

2.4.2.1. Canonical data model

To enable application of the proposed energy management services, the proposed μ GM anticipates an effective integration of ICT systems, distributed at the microgrid level, for which identification of a common domain model and language is fundamental. For this purpose, μ GM's defines a software integration layer where the shared Canonical Data

Model (CDM) enables connection among the developed systems and other ICT systems in microgrid environment (through proper gateways) and related data structures. The proposed CDM is then considered as an energy-domain application of the general CDM approach, where the overall energy system integration complexity is tackled through a common communication device. In other words, the use of a common data model and language enables a significant reduction of required interfaces between systems as depicted in Figure 8. A simple schematic depicting basic CDM functioning principle is depicted in Figure 9.

In order to enable the creation of an efficient collaboration framework among the involved entities, the following general objectives were to be met:

- Development of software-based services; While the computational concept of a service provides a concept of encapsulation that is rational also for business-level considerations, it also provides means for isolating technological solutions, allows modelling of autonomy of service providers, and naturally considers remote utilization of the services across the internet;
- Services are designed by creating platform-independent and computation-independent models of them, and using transformation tools to generate

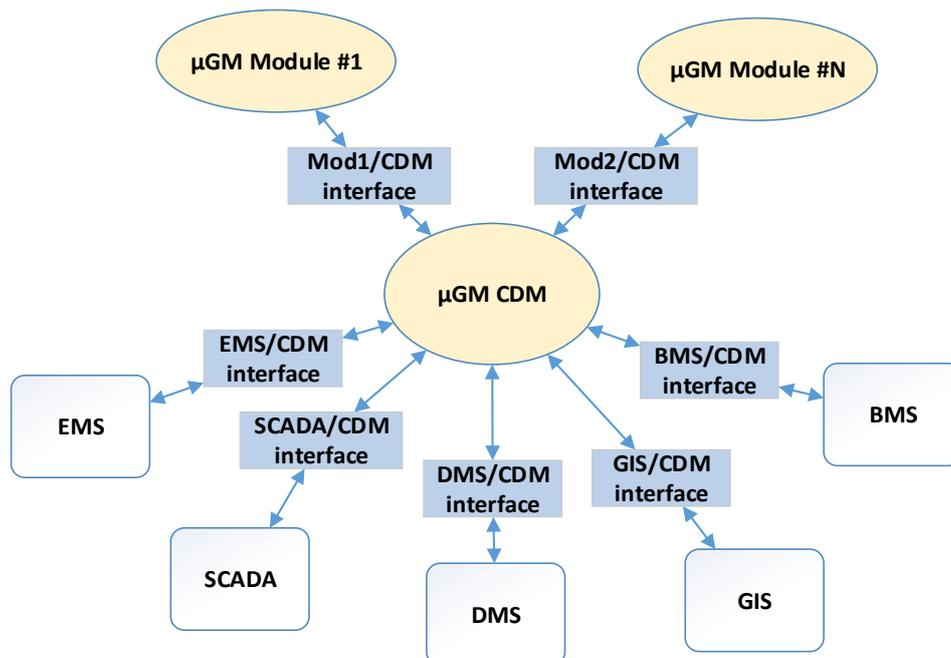

Figure 8: Communication among systems through μ GM CDM model

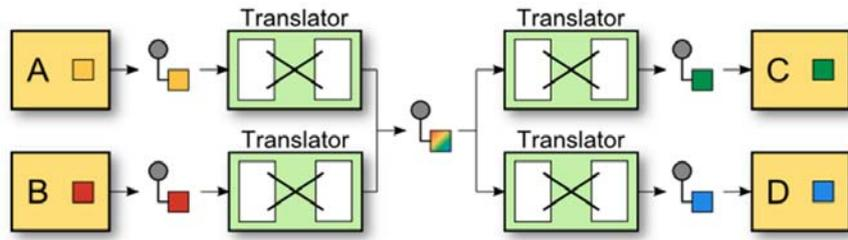

Figure 9: Standard CDM schema, source: Enterprise Integration Patterns

implementations (platform dependent models) of them, or to generate wrappers for legacy applications;

- Definition of a service-based interoperability domain among involved enterprises/ organizations; in this framework, the generic solution is governed with configurations, meta-models and policies for each specific need of interoperation among the identified actors.

μ GM interoperability approach also addresses the need to implement communication among software systems while leaving, as far as possible, a loose coupling between involved ICT components. This is achieved by having Web services as the transport layer for communication, and, specifically, by employing Simple Object Access Protocol (SOAP) in order to apply Web Services Description Language (WSDL) definitions to the CDM pattern. The choice of Web services (WS) enables the use of *de facto* standards, as far as integration technologies and frameworks are concerned, while the use of SOAP provides a language through which the service and software data model is shared. In this perspective, the μ GM interoperability objective is supported by a WS standard which allows to have a single software artefact (i.e. the WSDL file) describing all interactions with the middleware.

2.4.2.2. *Ontology-based information model*

The proposed semantic framework is based on a global ontology that integrates the local ontologies specific for the domains of interest of the μ GM actors: the global ontology acts as intersection of all these local ontologies and it is used to facilitate reusing of concepts and mapping of local ontologies. A global ontology can be also understood as a neutral reference, which results from the union of all local ontologies. A proper definition of a semantic framework enables the identification of an “agreement” on a common

definition and structuring of the identified concepts between people/actors with different skills and expertise in related domains, like ICT, energy, or building automation. In fact, in order to ensure the shared understanding related to product specifications and product descriptions, the parties must agree on how the data is classified and exchanged. The classification of the data practically requires a reference data system, which contains the terms used in classes and attributes, and their definitions. The ontological data modelling required a common and shared terminology: definitions of terms and their conceptualization are provided by the literature and international technical standards. This is the starting point to identify all the needed concepts and create, in the following steps, the semantic relationships among them.

Facility and context representation

In order to describe the facility, its components and surrounding elements, a semantic representation of all possible building elements, building automation system elements and energy consuming and producing devices that can exist in buildings (and in the neighbourhood), as well as of all possible relationships between all these elements, is to be created. A general taxonomy can be derived from the IFC (Industry Foundation Classes that is an open standard for Building Information Model - BIM) and extended by elements of the FBED (Functional Basis for Engineering Design) taxonomy, often used in mechanical engineering. It will guarantee that any building functional element and function will be modelled by its elements.

However, IFC is still limited in terms of sensor definitions, information which is necessary for the energy analysis of buildings, and other non-construction physical artefacts and devices; hence, the IFC model can be augmented, taking into account several European initiatives and research projects currently active on this topic. The IFC format became an official International Standard ISO/IS 16739. In addition, the activities performed by buildingSMART initiative, which is an industry-led community promoting openBIM, were taken into account while excluding those that are out of the scope of this thesis (namely, those related to construction industry. The buildingSMART Data Dictionary creates a catalogue of objects' names (the vocabulary) and brings together disparate sets of data into a common view of the construction project or asset, whether information comes from a product manufacturer, typical room requirements, cost data or environmental data.

In addition, it is also important to introduce the definition of the boundaries of the system with a specific reference to the “neighbourhood” concept. Based on the work performed in the NOBEL2 (Neighbourhood Oriented Brokerage Electricity and monitoring system) project, a neighbourhood is a geographically localized community within a larger city, town or suburb, sharing a common service infrastructure. In some countries, neighbourhoods are often given official or semi-official status, serving to represent administrative division found immediately below the district level.

Building Automation

In the building automation domain, the starting point to create an efficient data model is the effective description of the devices taken into account. Nowadays, the available description formats (EDDL ANSI/ISA-61804 2007 and CANopen EDS EN 50325-4 2003) are primarily specializing in device commissioning, configuration and testing [5] putting issues in the automated evaluation of their interoperability (the primary usage is to provide human readable product data sheets).

Currently, several standardized data models are in strong competition. The most applied ones are BACnet (EN ISO 16484), KNX (EN 14908), OPC (OLE for Process Control), and LON (ISO/IEC 14543-3, former CEN EN 13221-1), which are the leading ones in their particular sub-domains.

Smart Grids

Given that the μ GM system aims at operating in smart grid framework, following is a brief overview of the latest standardization efforts in this regard. The main challenge in the smart grid interoperability is that information is collected from different sources which are heterogeneous in terms of data structures, semantics, software and hardware platforms used [24]. Currently, there are several ongoing initiatives to establish “one to rule them all” set of standards for the smart grid coming from European Standardization Organizations (ESOs), as well as international bodies such as IEC and IEEE/NIST. To grasp the complexity of smart grid interoperability challenge, and ongoing efforts to overcome it, one may refer to the IEC SG standards map [25]. In Europe, Smart Grid Coordination Group (SG-CG), consisting of main European Standardization Organizations CEN, CENELEC and ETSI, was set-up in July 2011 to work under the EC mandate M/490 and deliver Smart Grid Architecture Model (SGAM), together with

mapping of existing standards and ongoing efforts in this respect. From their work, several important reference documents recently emerged, among which are the Smart Grid Set of Standards [26], Smart Grid Architecture Model manual [27] and Smart Grid Interoperability [28]. As stated by the SG-CG, during the period 2017-2018, the group will focus their efforts on establishing data format and procedures for data access and exchange for both electricity and gas, aiming at collecting information and finding viable solutions to converging practices in the EU. Furthermore, standardization committees such as CENELEC TC59X WG07, IEC TC57 WG21, OpenADR Alliance and Universal Smart Energy Framework (USEF) are working on particular smart grid interoperability standards, aiming to facilitate deployment of demand response mechanisms. The Table 1 summarizes the existing standards along the different Smart Grid functionalities and services elaborated in [29].

Meanwhile, Smart Grid information models that leverage Semantic Web techniques have been extensively investigated by [30], [31], [32] and [33]. The objective was to reach a common basis for semantics and syntax provided by a domain specific ontology. Although different application domains can define their own ontologies, they would typically leverage upon the Common Information Model. In turn, these ontologies can link concepts and properties to common ontologies, and Linking Open Data cloud.

Table 1: Standards for smart grid functionalities and services

| | Smart Grid Functionality and Service | List of Standards |
|--|---|--|
| Smart Integration of Distributed Generation and e-mobility | <ul style="list-style-type: none"> - Integration of distributed generation - Integration of electric vehicles - Integration of new usages such as storage, heating & cooling, etc. | <ul style="list-style-type: none"> - EN 50438 - IEC 61850 series - TS 50549-1 & 2 - ISO/IEC 15118 - IEC 62786, IEC 61851 |
| Smart Markets and Active Customers | <ul style="list-style-type: none"> - Enables DSO to act as market facilitator and grid optimizer - Facilitates demand response and demand side management programs - Aggregate distributed energy resources and e-mobility - Balance the power grid | <ul style="list-style-type: none"> - IEC 61968/61970/62325 (CIM) - IEC 62056 (DLMS/COSEM) - IEC 61850 series - SEP 2.0 - Open ADR ... |

Ontology matching systems that find complex correspondences by processing expert knowledge from external domain ontologies and using novel matching methods are currently under research, as revealed in [34].

The work presented in this thesis is completely in line with these efforts, as it integrates the demand response approach in energy management, on one side, and proposes an ontology-based solution for tackling the interoperability challenge on the other. In other words, it sets out the framework for semantic integration of different supervision and control systems and demonstrates new demand response applications on top of such integrated system.

3. Knowledge repository and semantic integration layer

As discussed in the previous chapter, the μ GM's holistic interoperability approach aims to enable seamless integration and semantic interoperability with existing, legacy, information systems, based on innovative metadata layer, leveraged by the semantic model of complex infrastructures. This metadata layer is, in fact, represented by the ontology-based information model, which is used for modelling and storing of contextual system knowledge, and the canonical data model, which is considered as a design pattern for the exchanged messages within the system. Although both items have been developed for the system, the following elaboration concerns only the ontology development and application of Semantic Web technologies, owing to their more significant scientific relevance.

3.1. Overview of the state of the art approaches

Currently, facility management systems, and energy management systems in particular, are characterized by high complexity, as they integrate heterogeneous devices coming from a variety of vendors, which often use proprietary communication protocols. To provide more intelligence to the existing management systems and allow for advanced management scenarios, such as operation scheduling and energy planning, it is necessary to tackle this underlying heterogeneity by classifying and formally describing different information within the target infrastructure, through a standardized and comprehensive data model. Although the focus of the proposed μ GM system lies in delivering advanced energy management solution, the developed data model considers a more holistic, generalized, framework of an entire facility, formalizing not only existing energy systems, but also significant energy users (SEUs), topology of interconnected systems, facility layout etc.

Application of the emerging advanced Semantic Web technologies represents the next step in evolution of energy management systems, which considers increased usage of open-source and/or standardized concepts for data classification and interpretation [35]. The advantage of such technologies is primarily in improving the interoperability and reducing the heterogeneity of the system, but also in better downward and upward compatibility of technical systems and accompanying software. By applying the Semantic Web technologies, it is possible to define a comprehensive facility data model, which

involves corresponding energy infrastructure, as a metadata layer, which classifies and describes relevant data within the domain of interest, i.e. the target facility. One way of providing such a facility data model is based on the concept of ontology modelling [36]. The ontology-based modelling approach is the most widely adopted Semantic Web paradigm and can be used for formal representation of knowledge through the definition of set of concepts within a domain of interest by describing their structure, behaviour and mutual relationships [37].

Additionally, by providing reasoning and inference capabilities, ontologies can be used to cope with some aspects of the “big data” paradigm [38] and to facilitate rapid exploitation of information. As “big data” represents large and complex collection of data sets that are difficult to process by using conventional database management tools, advanced technologies for efficient representation and handling of large quantities of data are still needed. Ontologies can make data become easier to retrieve, correlate and integrate, by transforming the information into knowledge, by attaching the meaning to data and by providing inter-relationships between modelled entities. As one of the pillars of the Semantic Web, ontology can be defined as a formal way of knowledge representation [37]. Apart from the classification and modelling of data and entities of interest, ontology can be used to reason upon the modelled domain as well. More precisely, ontology is used to define entities, properties, relations, actors and basic concepts, building a common vocabulary for all the elements of the domain in which it is defined. As such, ontology has a broad perspective of possible applications, such as sharing a common understanding among people and/or software applications, providing reusability of domain knowledge and making domain assumptions explicit [39].

When it comes to modelling of buildings and their energy systems, one may refer to a widely acknowledged Building Information Model (BIM). Ontology modelling can be seen as one possible paradigm for providing and implementing BIM of target facility. However, it is important to emphasize that opting for the ontology modelling approach, apart from the plain structural modelling of the domain of interest, a variety of advantages are provided such as reusability and automated reasoning upon the modelled entities. For instance, there exists a plethora of technologies that offer conceptual modelling (concerned with describing the domain of interest), but only ontologies combine this feature with Web compliance, formality and reasoning capabilities [40]. So far, a number

of facility ontology models were proposed in the literature, meant to improve home [41]-[45] and building EMS's [46]-[6]. For instance, the ThinkHome ontology, proposed in [41], is a part of an energy efficient smart home system, including concepts related to thermal comfort, building information and external weather. In [42] and [43], ontologies were proposed as a reasoning backbone of home energy management, which models the information about the home appliances, their energy efficiency and energy management strategies for the reduction of the energy consumption. One of the efforts to develop a smart building ontology is the SESAME ontology [46], which aims to describe an energy aware building and relationships between the objects and actors included within the energy conservation scenario. The other examples, described in [47] and [48] aim to optimize building energy consumption by developing an ontology which provides the decision support model for assessing the energy saving measures based on the measured data. Furthermore, in [49], an ontology-based EMS for buildings was designed to ease the implementation of new services and the integration of existing control systems. Finally, in [50] infrastructure components and energy metrics were modelled using an ontology that provides context-based information retrieval support to make energy aware decisions, regarding scheduling and resource allocation.

This section elaborates on the ontology-based information model, as a part of the metadata layer, which underpins the development of proposed μ GM system, by providing integration and interoperability of the underlying systems of the target complex infrastructures. The proposed ontology model was particularly defined to model all the static knowledge related to the relevant energy assets, installed within the target infrastructure (such as vendor data regarding the equipment characteristics of local energy generation, heat pumps, storages etc.), but also to describe corresponding ICT systems, responsible for their supervision and control (e.g. BMS/EMS). Furthermore, the role of the ontology was to provide a common vocabulary, in order to increase the interoperability and to enable transparent data transfer between different system components. The advantages of the proposed ontology, compared to existing facility data models, lie in information harmonization, semantic data enrichment (spatial tagging, topological relationship identification, signal/device dependency detection etc.), reusability, interoperability, extensibility, but most of all, in the facilitation of automated reasoning upon stored entities. More precisely, it facilitates reasoning (logical inference)

upon its entities, providing intelligent services, delivering more refined and useful knowledge (i.e. complex interpretation, abstraction, signal/device dependency detection, spatial positioning, data pre-processing, validation, correlation etc.), in comparison with the raw data provided by legacy building and energy management systems (BMS/EMS). A significant benefit of this unified ontology-based data model lies in the fact that it also represents a one-stop shop for all of the involved heterogeneous subsystems, i.e. a central point of access, configuration, extension, maintenance etc., thus ensuring consistency and coherence which are difficult to maintain in distributed data models.

The novelty of the proposed facility ontology model resides in encompassing both characterization of the facility infrastructure entities and facility management activities. Contrary to the existing models, which are usually focused solely on specific facility aspects, mainly structural/topological, the proposed ontology offers comprehensive facility infrastructure model, starting from the field-level devices and signals, to the communication means, to the high-level systems from technical, functional and topological perspective. Since comprehensive facility data models are lacking in the literature, particularly in the energy domain, this thesis aims, among other things, to present the general concepts behind the facility ontology modelling approach and its role within an EMS. The task of ontology modelling was to structure and classify the semantics, i.e. the technical characteristics of the systems operating at the site. The ontology was modelled in such a way to facilitate the interpretation and semantic enrichment of signals coming from the field-level devices, thus enabling the high-level information for the end-user. At the same time, the ontology enables the μ GM Energy Management Applications to use a knowledge-driven analysis (instead of a data driven analysis) to find optimal operation scheduling or conduct appropriate energy planning for a targeted infrastructure.

To provide the reusability of domain knowledge and support to the concept of Linked Data, the proposed ontology model was linked to other existing ontologies and information models such as Suggested Upper Merged Ontology⁴ (SUMO), Common Information Model⁵ (CIM) and Industry Foundation Classes⁶ (IFC). In this way, by

⁴ Suggested Upper Merged Ontology (SUMO), [link](#)

⁵ Common Information Model (CIM) Users Group, [link](#)

⁶ Industry Foundation Classes (IFC) data model, buildingSMART, [link](#)

referencing and making the semantic relations to already existing concepts, the interoperability of the proposed ontology model with existing approaches was supported [57]. Initially, the core facility ontology was defined to represent the generic facility model (integrating common concepts of complex infrastructures in general) and provides general modelling guidelines. Further extension and population of the core facility ontology lead to the full-blown model of the specific facility infrastructure of interest. In addition, the corresponding relationships among the modelled devices, as well as the signals going to/from them, were defined. Apart from the facility data model, the proposed metadata layer also includes an adequate ontology application program interface (API) aimed at facilitating extraction of the stored data. The ontology APIs were developed for seamless integration of the ontology-based facility data model with the rest of μ GM components.

3.2. Ontology engineering methodology

Ontology represents one of the building blocks of the Semantic Web and can be defined as a formal, explicit specification of a shared conceptualization [58]. In other words, it is a formal way of representing the knowledge as a set of concepts and their relationships within a domain of interest. In this thesis, the ontology-based facility data model, generic at first, was developed with the aim to improve the energy efficiency of the target infrastructure/building. The main aspects provided by the proposed ontology within the integrative energy management system would be the following:

1. modelling the domain of interest (the target infrastructure/building) by classifying installed systems and field devices/signals,
2. technical characterization and semantic interpretation of low-level signals (to which field device signal belongs, what its characteristics are, relation to other signals etc.), and
3. providing the topological profile of the target infrastructure (geographical location of the field devices and belonging signals).

By utilizing the ontology concept, the aim was to model the semantics, i.e. to structure the technical characteristics of the systems relevant from the energy management perspective. Furthermore, the ontology-modelling concept has been selected as the core IT technology to build the transversal middleware, which could provide a homogeneous

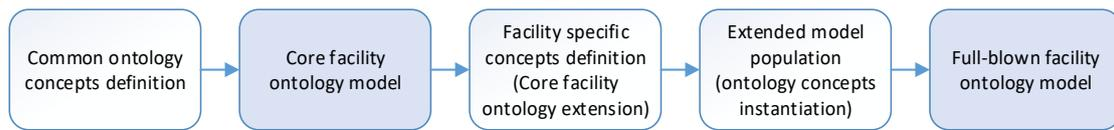

Figure 10: Facility ontology model development

and common integration platform for diverse field devices supervised by the μ GM. This approach provides consistent, yet flexible means for classification and description of each device/signal being addressed by the μ GM. In that way, the ontology was used to provide semantic enrichment of signals coming either directly from the field devices or as an output of the advanced energy management applications, thus delivering contextual information about suggested energy management action to the end-user.

3.2.1. Core facility ontology

The Figure 10 presents necessary ontology development steps from the definition of common ontology concepts to the full-blown facility ontology model. As depicted, at the initial stage, the core facility ontology was developed, providing a generic facility model that represents a common complex infrastructure. It is comprised of the common concepts identified as relevant from the perspective of the facility modelling, usually present in any type of complex infrastructure. To identify the common concepts, various types of facilities were analysed such as university campuses, airports, exhibition centres, sport arenas etc. The purpose of the core facility ontology is to provide the modelling guidelines for the description of the technical characteristics of systems installed at the site, and for definition of their topological profile (considering, for instance, the location of the modelled entities). Initially, it was necessary to define the modelling approach and the general concepts behind the modelling. Those issues highly influenced the decision regarding granularity, abstraction and classification of different real world objects at different levels of the ontology hierarchy.

OWL is one of the most applied ontology modelling languages built upon RDF(S), and was used for the development of the core ontology model [59]. This included definition of the ontology classes, arrangement of the class hierarchy and definition of the properties and their possible values. The concepts, i.e. the ontology entities identified as part of the core facility ontology model, are described in the following subsections. In total, core facility ontology consists of 33 classes (or entities) and 41 properties, 14 of which are

objects and 24 are data-type properties. Starting from this generic model, the following steps included further extension and instantiation, i.e. population of the core facility ontology in order to model a specific target infrastructure. Once the ontology model is populated, the end-user does not have to understand and deal with the ontology as a modelling paradigm. Furthermore, all the static knowledge stored within the ontology is accessed by an end-user through a simple and intuitive application program interface and presented in an easily understandable manner through the appropriate graphical user-interface.

3.2.2. Compliance with modelling standards

Harmonization of the facility ontology model was performed by linking to other existing ontologies and information models. The reuse and extension of existing models should be taken as one of the general objectives to avoid potentially large overhead in ontology engineering (by modelling already existing concepts) and to support the interoperability with existing approaches [57]. As part of the efforts undertaken to establish the semantic correlation with other existing ontologies, SUMO, which is the largest high-level ontology today, was taken as a starting point for the development of the facility ontology model. More precisely, the proposed ontology was leveraged upon the basic SUMO concepts, as will be indicated in the following subsection. Considering it is an upper level, domain-independent ontology, which provides a framework by which disparate systems can utilize common knowledge, and from which other domain-specific ontologies can be derived, it facilitates metadata interoperability and knowledge sharing among SUMO compliant ontologies. In this way, by means of upper ontologies, the developed model was made generic in nature.

CIM was taken into account as one of the leading standards in the energy management domain. The basic CIM data model, derived from IEC 61970 series of standards [60], was partly used for development and alignment of the facility ontology. Furthermore, IFC data model was also taken as a standardized specification for BIM. These standards affected the definition of the basic domain entities such as the data types, devices, (sub)systems etc. In addition, based on the development activities of the facility ontology

proposed in this thesis, contribution to the current building data-model standardization efforts was made through the EU Energy Efficiency Semantics collaboration platform⁷.

3.2.3. Facility modelling approach

Contrary to the existing models, which usually elaborate only specific facility aspects, the proposed modelling approach was aimed to offer a comprehensive facility model, encompassing both the structural/topological characterization of the facility infrastructure entities and behavioural characterization, i.e. facility management related activities. To provide the insight into the chosen modelling approach, this subsection presents some of the main entities of the core facility ontology class hierarchy in a top-down approach, including their interdependencies. The highest entities of the ontology class hierarchy, which were inherited from the SUMO standard, and their relevant decomposed (sub)entities are the following:

- a. **“abstract”** - for modelling of the abstract entities such as data types, communication protocols, maintenance procedures and operation cycles of devices etc.:
 1. **“dataExchange”** - for definition of the data types and communication protocols used for data exchange among device and components of the integrated system;
 2. **“policy”** - for modelling of the device management procedures from the perspective of system operation and maintenance.
- b. **“physical”** - for modelling of the real world objects such as entire systems with associated devices and signals:
 1. **“plant”** - for modelling of concrete (sub)systems installed at the site (such as on-site thermal energy/power generation, storage, heating/cooling system (HVAC) etc.) starting with signals, through components and devices (inverters, air handling units (AHU), electrical switchboards, lighting devices etc.) to overall (sub)systems;
 2. **“topology”** - as the base for definition of the topological model of the target infrastructure and its facilities by using “area”, “zone” and “sector” subclasses.

⁷ Energy Efficiency Semantics Collaboration Platform (eeSemantics), [link](#).

Facility modelling encompassed the definition of the entire facility infrastructure from high-level (sub)systems to low-level signals. Therefore, the base class “plant” (inherited from IEC 61970-Part 301 (CIM base) standard [60]) was modelled through its main subclasses - “system”, “device”, “component” and “signal”, thus reflecting the top-down infrastructure of a particular system. As a top-level entity of the “plant” class hierarchy, class “system” should model the entire integrated (sub)systems, on-site generation, water supply etc. The following subclass of the “plant” entity is class “device”, which represents a standalone piece of equipment installed at the site, constituting the designated technical system. The “device” class (inherited from IFC) is further decomposed to “actuator” (actuating devices such as ventilation fans or circulation pumps), “sensor” (metering equipment such as flow meters and sensors) and “functional” entity (devices that provide some service to the environment, such as heat exchangers, storages or filtering compartments). Class “component” is modelled also as a subclass of “plant” entity and it may represent specific parts of more complex devices, which could be considered at the same time as standalone entities (such as control valve of cooling/heating coil etc.). Finally, the lowest-level entity of the “plant” class hierarchy is class “signal” which should model particular signals going to/from the controllable (actuators) and readable devices (sensors). Furthermore, it may be modelled as a “setValue” type of control signals used for setting the actuator’s operation state or target value, or as an “alarm”, “measurement” and “state” type of reading signals used to indicate the operation state of corresponding device or certain measured value.

However, to the best author’s knowledge, current BIM/IFC definitions do not accommodate modelling of distributed energy resources, renewable energy sources nor storages. Therefore, an extension in this direction was necessary to cross-fertilize design ideas and alternatives across architecture, engineering and construction (AEC) domains. As an example, when represented in IFC schema, a particular surface covered with photovoltaic panels will be shared by: 1) an electrical engineer to find out the expected production profile, affecting the design of electrical system; 2) an architect to determine the impact on the building element containing them (e.g. roof or wall); 3) a contractor to quantify and procure the appropriate panels. Moreover, considering the focus and framework of this thesis, joining the knowledge about building and renewable energy sources will allow for automated extraction of critical building information, embedded in

IFC schema (such as surface tilt, area and orientation) impacting estimation of renewable source production profile.

Given the focus of the overall μ GM system, the previously introduced class hierarchy is inserted with a breakdown of class “system”, specifying DER, RES and storage elements that constitute the microgrid. This comprises “production_unit”, “storage_unit”, “conversion_unit” and “consumption_unit”, as well as the units responsible for implementing the three control levels necessary for every microgrid, the “MGCC” (Microgrid Central Controller), the “LC” (Local Controller) and the “PCC” (Point of Common Coupling), as defined in [61].

Each of them is further specified with a set of appropriate sub-classes and, finally, the hierarchy is continued with the class “device”. As an example, following is a brief description of the concept “production_unit”, also depicted in the excerpt of the overall facility ontology in Figure 11.

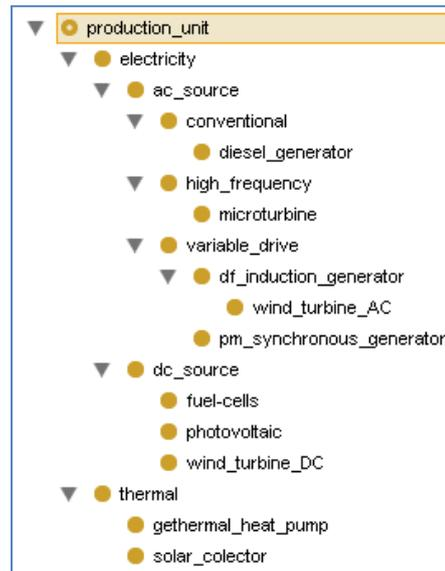

Figure 11: Ontology tree – Production unit

The “production_unit” class is seen as general energy production element, which is, at the first level, broken down to “electricity” and “thermal” sub-classes, thus differentiating the two kinds of energy that can be produced within a microgrid. Going further in depth, the “electricity” class is specified into “ac_source” class, which contains “conventional”, “high_frequency” and “variable-drive” generators, and “dc_source” class, split into “photovoltaic”, “wind_turbine_DC” and “fuel-cells”.

For each of these classes, a list of properties (attributes, slots) has been introduced, thus providing all the necessary parameters for describing a given entity. This list was carefully chosen having in mind the required knowledge in order to operate the microgrid itself, on one hand, and to perform the energy management strategies on the other.

As an example, a property list that is used to describe and define a photovoltaic panel is presented using the Protégé Instance editor. Since the class “photovoltaic” is a subclass

of a class “DC_source” and therefore class “production_unit”, it inherited all their properties, as depicted in an excerpt from Protégé instance editor in Figure 12.

The property slots found outside the red boxes belong to the abstract class “production_unit”, and therefore they are inherited in every subclass lower in the hierarchy. They are used to describe some general aspects of a device such as device ID, model, manufacturer, equipment, installation and maintenance costs and the subsidies. Furthermore, the boxed attributes on the right hand side are inherited from abstract class “dc_source” and define rated and output power of a device, whereas the properties on the left hand side actually describe the specific features of photovoltaic panel, such as panel width, panel length, temperature coefficient, NOCT (Nominal Operating Cell Temperature) and expected lifetime. Finally, in order to define the relations among defined entities, properties were used to indicate which components compose a specific device or system (property “partOf” and inverse one “aggregatedOf”). On the other hand, property “connectedTo” was used to indicate the logical aggregation of device instances (not necessarily physically connected). Operational cycles (working hours) of the field elements were defined through the property “schedule” (modelled as a part of the “policy” entity of “abstract” class). Furthermore, relations among actual equipment and signal entities were defined, indicating which signal belongs to which device or component (property “belongsTo” and inverse one “belonging_signal”). Signals are further defined with properties indicating their unique identifier, data type (modelled within “dataExchange” entity of “abstract” class), their description and source (such as BMS, specific device etc.).

The aim of modelling the topological aspect of the target facility was to provide the information about the specific functional area or location of field devices, which could enable the interpretation of the incoming signals in terms of their source location. As elaborated previously, the main entity of the “topology” class hierarchy is class “area” representing any topological unit of the facility. The lowest-level entity of class “area” is the class “room”, which should represent the premises, offices, halls etc.

Moreover, specific entities were defined in order to model complex topological units. For example, floors (class “level”) were defined as aggregation of all “area” instances located at the same level. In addition, specific topological entities (classes “sector” and “zone”)

| INSTANCE BROWSER | | INSTANCE EDITOR | |
|-------------------------|-------------------|--|-------------------|
| For Class: photovoltaic | | For Instance: coreOntology_Class10017 (instance of photovoltaic) | |
| coreOntology_Class10017 | Device Id | Photovoltaic1 | Equipment Cost |
| coreOntology_Class10018 | Model | 48E6+3bb195F | 1400.0 |
| coreOntology_Class10019 | Manufacturer | Enfoton Solar | Installation Cost |
| coreOntology_Class10020 | Panel Width | 1.1 | 307.7 |
| coreOntology_Class10021 | Panel Length | 0.6 | Maintenance Cost |
| coreOntology_Class10022 | Temperature Coeff | -0.4 | 40.0 |
| coreOntology_Class10023 | State Grant | 30.0 | Rated Power |
| coreOntology_Class10024 | Exp Lifetime | 25.0 | 0.195 |
| coreOntology_Class10025 | Noct | 47.0 | Output Power |
| coreOntology_Class10026 | | | 0.5 |
| coreOntology_Class10027 | | | |
| coreOntology_Class10028 | | | |
| coreOntology_Class10029 | | | |
| coreOntology_Class10030 | | | |
| coreOntology_Class10031 | | | |
| coreOntology_Class10032 | | | |
| coreOntology_Class10033 | | | |
| coreOntology_Class10034 | | | |

Figure 12: Protégé instance editor – photovoltaic entity properties

were modelled in order to represent certain logical aggregation of several premises. For instance, the class “sector” was used to model the high-level topological units such as, in the case of the airport, buildings, hangars, runways etc. On the other hand, class “zone” was used to model smaller areas as compared to class “sector”, such as terminals or gates, which can be still seen as physical and/or functional aggregation of actual premises. Specific properties were defined to indicate the relation between aggregated and single area instances (property “partOf_area” and the inverse one “aggregatedOf_area”).

For topological mapping of the field-level devices, property “contains” (with its complement, “locatedAt”) was defined to indicate which devices are installed in a certain area. All area instances were modelled with properties describing their topological relation to other neighbouring areas (“connectedTo_area” and “adjacentTo_area”), which could be found useful in spatial correlation of the received data. Moreover, “area” instances were defined with additional attributes indicating their unique identifier, surface area and volume.

3.3. Ontology as integration layer

Further to an extensive overview of the main ontology aspects, the following description is primarily focused on further elaboration of the potential benefits for the proposed μ GM

solution, by having an ontology-based metadata layer as a common integration and interoperability platform for diverse, heterogeneous ICT systems. Namely, the proposed metadata layer, leveraging upon the ontology-based knowledge store and canonical data model as uniform messaging format, aims at providing the semantic enrichment of the signals coming from the BMS, additional sub-metering and data loggers, or external sources, thus offering contextual high-level information to the energy management applications, as well as operator/end-user for further analysis. Considering the previously presented ontology features, it is important to highlight that all stakeholders and the μ GM components, will be able to share the knowledge about the system and to understand each other when referring to the same concept. For instance, the underlying supervision and control platform (being either BMS, EMS or IoT-based monitoring platform) typically uses its proprietary data naming format for the representation of the sensor readings, whereas, an external module/application may use its own data naming format. In this way, the high-level energy management applications, communicating the acquired data and proposed actions to the end user, can provide semantically enriched information about particular energy asset, such as its technical properties, interconnection with other assets, physical location within the infrastructure etc., instead of the non-intuitive asset identifiers (IDs). All this heterogeneity in different systems and data formats introduces critical interoperability issues and requires tedious translation procedures in communication between individual system components. The proposed metadata layer aims to solve this problem by leveraging its implementation on the utilization of a holistic ontology-based facility data model. Thus, the three fundamental features are enabled:

1. the knowledge about the system is centralized and stored within the ontology-based facility data model, providing critical semantic relations within the domain of interest;
2. by establishing a common vocabulary of the system entities, the facility data model enables all system components to “understand” each other when referring to a particular entity, in a seamless and transparent way;
3. having a centralized knowledge repository, all relevant information are being up to date, consistent, synchronized and accurate.

Considering the proposed metadata layer is based on the ontology, its integration into the overall μ GM solution is provided by the corresponding knowledge discovery service,

which involves specific ontology interface. The main responsibility of such interface is to enable knowledge extraction, as well as delivery of the requested information, such as technical characteristics of the field-level energy assets, supervision and control devices and systems, their topological information etc., in a transparent way. In other words, a custom designed application program interface (API) is necessary to integrate ontology-based knowledge repository and provide seamless extraction, acquisition and reasoning for the rest of system components.

In relation to this, a detailed ontology-supported information flow and knowledge extraction is depicted in Figure 13. As previously elaborated, the relevant information for the μ GM's EM applications come either from a resource layer, comprising BMS system, meters etc., or various external sources, comprising meteorological forecast service or energy pricing forecast service. Furthermore, additional measurements such as indoor ambient, or people presence, may come from an independent IoT based monitoring/sensing platform and could be used to enrich diagnostics of the most critical energy consuming devices (e.g. heating is used in room with no people, or there is an open window). In either way, the relevant information is first wrapped into a custom CDM (XML/JSON format) at the corresponding gateway according to a custom, pre-defined, data naming convention. The data are then forwarded to the middleware layer. Collected data, carried within the CDM formatted messages, may contain a wide range of performance monitoring parameters including electricity consumption measurements, on-site production, storage status etc. However, the CDM messages, gathered within the middleware layer, do not carry the semantics related to the data point they represent. To illustrate, a data point is labelled by a specific system defined ID, which may, in general, even represent a random set of characters, having no association with the device it represents nor its attributes (like the rated power or specific deployment location), whereas the entire semantics and contextual knowledge is stored within the ontology. Otherwise, the middleware would have to be aware of, and exchange custom messages with each information source, following their proprietary data naming convention, in order to properly interpret the information of interest. This issue is, therefore, bridged with the introduction of a common metadata layer, hosting the facility data model and accompanying API. Each CDM message is first parsed in order to acquire the source device ID (for instance, device that triggered an alarm) and corresponding

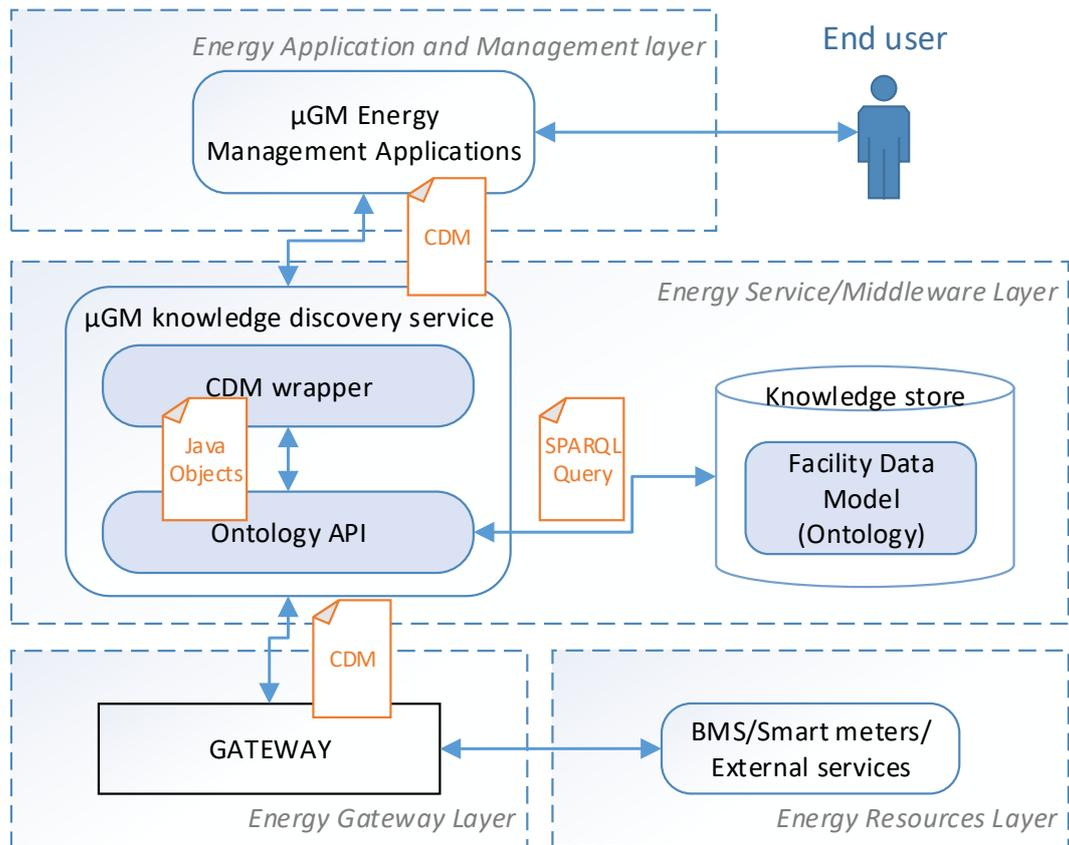

Figure 13: Information flow and knowledge extraction

measurement/status value. The extracted device ID is then used to query the ontology in order to obtain additional relevant information, such as full specification of the device, which system/sub-system it belongs to, what the neighbouring devices are, where it is located within the facility itself. Querying is performed through the ontology API, which has several functionalities ranging from generation of SPARQL [62] queries, where SPARQL stands for a recursive acronym for SPARQL Protocol and RDF Query Language, to communication with the ontology data store and offering the gathered information in appropriate format to the rest of the system. The facility ontology can reside, without any restrictions, either locally, within the μ GM's deployment environment, or on a remote server, serving as a remote knowledge store (e.g. using Virtuoso Universal Server). Regardless of the implementation, the overall communication chain is completely transparent for the stakeholders, owing to the developed API. In this way, the facility ontology model can provide critical semantic enrichment of the signals coming from devices/systems, thus enabling the energy

management applications to deliver high-level, immediately applicable, energy conservation measures to μ GM end-users.

3.4. Software implementation

3.4.1. Ontology development and instantiation

For ontology modelling, OWL, as one of the most utilized modelling languages, was used. Protégé⁸ tool was selected, as ontology development framework, used not only for modelling, but also for ontology instantiation. Another ontology development tool, the TopBraid Composer⁹, was used for refinement of ontology instances. In general, the ontology instantiation may pose significant effort depending on the infrastructure complexity and number of energy assets/devices/sensors. Although the ontology instances may be inserted manually, through Protégé environment, there are several ways of automating this process, i.e. to extract information from existing, structured, data sources. To illustrate, one may use existing excel sheet (or .csv), with the list of devices and their corresponding properties, to automatically insert this information into ontology, i.e. create instances corresponding to each device and mapping their properties into appropriate attributes. Having said this, the following are the three different yet complementary approaches that have been considered for mapping of information into an ontology:

- LODRefine/OpenRefine tool¹⁰,
- SPIN mapping [63], and
- SPARQL Update queries [64].

LODRefine is a Linked Open Data (LOD)-enabled version of OpenRefine tool for cleaning, linking and transformation of data from one format into another. It is a part of the LOD2 Stack, developed as the output of the FP7 project LOD2 (Grant Agreement No. 257943), in which the Institute Mihajlo Pupin also took part, and it is comprised of tools for managing the life cycle of Linked Data [65]. For the purpose of this thesis, LODRefine tool was utilized for automatic translation of information stored within BMS data point lists (in form of Excel sheets for both MXP and FCO airports, the use cases elaborated in Section 6) directly into the RDF triplets, simply by defining the translation rules via

⁸ Protégé tool - Open-source ontology editor and framework for building intelligent systems, [link](#).

⁹ TopBraid - Ontology composer tool, [link](#).

¹⁰ LODRefine/OpenRefine tool - A Power Tool for Cleaning Data, [link](#)

corresponding LODRefine user interface functionalities). The extracted RDF triplets, carrying the additional semantics, regarding the newly created instances and their corresponding property values, are subsequently imported as OWL ontology model into the core ontology model using the Protégé editor. In this way, the LODRefine tool was first utilized to perform extension of the core ontology and then for the population of the extended ontology model. At the same time, this approach provided the possibility to perform the “raw” mappings and alignment with a given data point naming convention in completely automatic manner, while the following two approaches were subsequently considered as more convenient for “fine tuning” of the airport ontology in semi-automatic manner as it will be described further on.

SPARQL Inferencing Notation (SPIN) [63] is a SPARQL-based language used for representation of the mappings between RDF/OWL ontologies. It is used to transform instances of source classes into instances of target classes. Furthermore, it is used for definition of rules that map not only the entire instances, but also their specific properties/values. For definition of mapping rules, SPARQL CONSTRUCT keyword is used to map classes from one graph pattern to another, while binding the source and target classes was performed in the WHERE clause of the SPIN mapping rule shown below. Following this approach, instances and corresponding relations/properties have to be initially extracted (such as from the EMS data point lists) and imported as RDF triplets (simply by importing the corresponding CSV file carrying the source information) that could be further mapped (taken as a source objects with corresponding property values) into the target model, i.e. the entities of the previously extended airport ontology model (by using the SPIN mapping rules). Based on the corresponding pre-defined mapping rules, desired relations are established, not only among already existing instances (generated by using the first approach), but among the newly imported ones as well. Additionally, SPIN mapping language is a high-level language that is suitable to be edited graphically (simply by drag and drop of source/target classes), as provided by the TopBraid Composer.

Final “fine tuning” of the ontology model was performed through the SPARQL Update [64] queries, performed from the Java script directly upon the ontology model, i.e. the OWL file. SPARQL Update is an extension of the SPARQL query language that provides

the ability to add, update and delete RDF data. It enables the generation of specific SPARQL Update queries, including commands such as MODIFY (for modifying the existing instances), INSERT (for inserting the newly created instances/property values) and DELETE (for deleting the existing instances/property values), based on which the target entity property can be updated according to the handled data. New instances and property values which should be inserted/modified in the ontology model could be manually defined either within the Java script itself (through corresponding query arguments) or extracted from the source Excel sheet, handled by JAVA Excel API¹¹. This approach allowed “semi-automatic” handling of the already created ontology instances, i.e. it provided the possibility for an update of the target instances and corresponding properties/relations of airport ontology. For performing alignment and mapping tasks, patterns of SPARQL update queries were defined, based on which the corresponding modifications were carried out (within the JAVA script).

3.4.2. Interfacing with Ontology

In order to extract and deliver the required information, stored within the ontology, an appropriate application program interface (API) between the ontology and the rest of the system components had to be defined, as depicted in Figure 13. Therefore, the ontology API was developed to entail a range of critical functional requirements, providing a transparent interface for integration of the facility ontology model and other software components within the EMS. The following are several examples, illustrating employment of the relevant ontology API functionalities:

- *Technical characterization and semantic interpretation of signals* – enables field-level asset/device semantic characterization based on the unique device ID, embedded within the messages/signals coming from remote terminal units/devices/sensors, providing relevant technical parameters (extracted via SPARQL queries) such as device rated power, efficiency or capacity or topology information such as to which system it belongs, how and to which device/component it is connected, where it is located etc.
- *Update of facility ontology model* – enables updating of specific class instances and their properties, based on the received information/data from sensors/systems

¹¹ Apache POI - the Java API for Microsoft Documents, [link](#).

(using SPARQL Update commands). Update arguments are considered to be both unique device identifier and desired property value.

- *Application of a generic inference engine* – in order to maintain consistency of the data stored in the ontology, a set of rules defined in the Semantic Web Rule Language (SWRL) [66] is used by the suitable inference engine, which is responsible for reasoning upon the class instances. For instance, corresponding relations among class instances could be automatically established as a result of reasoning, such as in the case of transitive relations (e.g. if there is a device belonging to a specific system, then the components of this device belong to the same system as well).

Furthermore, the ontology API features both local and remote access to the ontology, thus enabling high flexibility in the overall system architecture. The following subsection describes interfacing with the ontology in more detail, entailing both scenarios.

3.4.2.1. *Local access*

In the case when the ontology is used to store only static data, which will rarely or almost never change, there is no need to store the ontology at a remote server, since it will create an unnecessary communication burden and decrease the reliability, due to the potential communication failures, thus resulting in a less robust system. Instead, the same ontology instance should be deployed “locally” at the side of each stakeholder.

From the technical perspective, given that the core system components were implemented as Java applications, the developed μ GM ontology API was developed based on Apache Jena¹², which is an open source Java framework for building Semantic Web and Linked Data applications, offering a wide range of functionalities, when it comes to the operation with the other ontologies and/or RDF stores. Once developed, the custom designed ontology API is distributed in the form of a library, which has all the aforementioned functionalities implemented within. Several practical examples describing the main features of the developed ontology API in the case of the locally stored ontology are given in the code snippets in Appendix I:

¹² Apache Jena Framework - A free and open source Java framework for building Semantic Web and Linked Data applications [link](#).

- **Technical characterization and semantic interpretation of signals** – energy asset characterization based on the unique device ID (e.g. “P4.1”) found in the incoming signal from sensors and extraction of its relevant technical characteristics, such as device power, (?power), to which system it belongs (?sysID), to which devices and components it is connected (?devID ?compID) and where it is located (?areaID).
- **Updating the knowledge base repository** – based on the received information/data from sensors, a specific entity property can be updated. As arguments for the update, a unique device identifier, as well as a new property value, is utilized.
- **Applying a generic inference engine** – In order to maintain consistent information within the ontology, a set of rules between entities and their corresponding properties can be developed. These rules are further transferred towards the inference engine, which is responsible for reasoning upon the ontology instances. In this example, it is shown how to transfer the information about the system a specific component belongs to, if there is already such information about a device, which this component constitutes. In this case, property value (partOf_system) for a specific device is used to create a new triplet, which suggests to which system the device belongs to, as well as the component belonging to this device (partOf_device).

The developed ontology API for local ontology access comprises different classes for the aforementioned functions, as well as associated resources, which is in this case an .owl file, containing both the ontology class hierarchy and its instances. Finally, the ontology API has been distributed as a separate Java archive (JAR) package file.

3.4.2.2. Remote access

In case of distributed applications, operating over the same physical infrastructure, it is of vital importance that they share the same knowledge base, which keeps synchronized all the changes in the overall class hierarchy, as well as class instances. In such way, changes made by one application will be immediately reflected in another in the same way as of a shared database. Therefore, for such case, the ontology is deployed on a centralized server, where it provides easy access to all actors. For the purpose of the μ GM

implementation with a remote knowledge base, a centralized Virtuoso Universal Server¹³ was utilized. Considering the Virtuoso functionalities, querying the ontology can easily be performed in a web-service based manner (by sending the requests in order to query the ontology) and the extracted information can be wrapped up into the XML based message, sent as a response. However, in order to avoid building the corresponding XML schema and manually creating the XML messages each time the communication is requested, one could take advantage of the built-in SPARQL endpoint within Virtuoso Server. This would enable user to have transparent and utterly simple communication with the server, using only the HTTP protocol. Nevertheless, in this case, the response from query is received in the form of XML and requires further parsing in order to store the information appropriately. Therefore, further effort was put in finding a way of utilizing the technologies that would simplify this procedure. Again, Jena framework was used in order to create queries and, more importantly, to initiate a communication with the Virtuoso server. However, during this research it was revealed that only the SPARQL Query language is supported in this way, whereas if the SPARQL Update commands are needed, an original solution using the HTTP protocol must be utilized.

The code snippets in Appendix II represent excerpt of the Ontology API code for accessing a remotely stored ontology in several different ways:

- **SPARQL Query (Jena)** – To query the ontology from a remote server, the first option is to employ the Jena framework. It requires preparation of the SPARQL query in the exactly the same way as for the local access, whereas the only difference lies in the method called for the execution of query. In this case, apart from the query itself, the method requires the Virtuoso SPARQL endpoint location. This method, in fact, wraps the query in a XML message, implements a web service and communicates with the endpoint, thus making it all transparent to the developer.
- **SPARQL Query (HTTP)** – The second, less favoured, option for querying a remotely stored ontology is via HTTP protocol, in which case a POST request method is utilized and the query itself is embedded within it. The main

¹³ Virtuoso Universal Server - A Modern enterprise-grade solution for data access, virtualization, integration and multi-model relational database management (SQL Tables and/or RDF Statement Graphs) [link](#)

disadvantage of this approach, comparing to the one, which utilizes Jena framework, is that it requires parsing of the response, which is received in XML format. Therefore, manual post processing is needed in order to extract and store the information appropriately.

- **SPARQL Update** – In case of the SPARQL Update commands, Jena framework does not provide support for accessing a remote web-service, and the only option is to use HTTP protocol. In this case, the procedure is almost identical as sending the SPARQL Query (HTTP) requests except that, because of security reasons, the URL has to include access credentials, since the Virtuoso server requires authorization when any of the SPARQL Update commands are issued and they are, consequently, affecting the stored ontology.

Similarly as in the case of local ontology access, the ontology API for remote access is distributed as a separate JAR package file, which contains corresponding classes for different access options, as well as the .owl ontology file.

4. Scheduling service for optimized operation of hybrid microgrid

As highlighted in the introductory section, global trends in energy policies have fostered the development and adoption of novel technologies, control paradigms and management techniques for improving general system performance and attaining long-term objectives, set forth in terms of environmental targets and economic constraints. Future energy systems will, therefore, increasingly combine the features borne by typically large, dispatchable and conventional energy sources with those of relatively small and intermittent renewables. Running the overall system in the most effective way has thus become an issue of increasing importance, since it features units with both complementary and conflicting characteristics. This is, furthermore, relevant not only at a grid level, but also on the scale of industrial, commercial and even residential installations. Such issues are additionally complicated by the fact that the energy networks for different carriers (e.g. electricity and gas) will foreseeably be more closely interconnected in the future, due to the presence of novel conversion units and storage devices, which will also be commonly deployed and operated.

The aim of this section is, therefore, to elaborate on the development of Optimisation engine, by explaining the underlying methodology, adopted mathematical representation of energy infrastructure, corresponding optimisation algorithms and, finally, its implementation as an independent service within the Energy Management Application Layer of the μ GM system.

4.1. Overview of the state-of the art approaches

The problem of how to deal with an assorted set of energy related components, technologies and boundary conditions, is often referred to as the energy dispatch problem in the literature, and novel formulations have been derived over the course of the last decade, in order to adapt it to the requirements of distributed generation units. One such solution was proposed in terms of the concept of energy hub modelling [67], which leverages the potential of a specific, constrained set of energy assets – referred to as a hub - to provide the optimal energy dispatch for a given demand. It takes information related to the price and availability of external energy carriers, the forecast of the expected renewable energy contribution, the physical characteristics of conversion units and

storage devices present on-site and the load prediction as input to solve the problem of determining the optimal energy procurement and technology utilization.

In parallel, recent research work has also focussed on removing the assumption that the load is given and fixed, and on investigating viable demand side management (DSM) approaches that dynamically adjust the load, within given boundaries, in order to fulfil or improve a specified performance requirement. These methods yield additional flexibility and introduce new degrees of freedom in novel energy-management approaches, since the load had otherwise been assumed passive and static in classic formulations. A number of approaches for the formulation and solution of optimisation problems have been proposed in the literature, such as those related to the dimensioning and operation strategy selection [68]-[72], planning of distributed and micro-grid energy systems [73]-[76], [77]-[79], MILP (mixed integer linear programming)-based evaluation and scheduling of energy units [80]-[85], and energy management and planning tools [86]-[88]. One of the first models for the optimisation of non-renewable energy sources, demand, emissions and operating costs for a given municipal system, was proposed in [68]. In [69], a tool was described for the sizing and operational optimisation of system units, which was applied in [70] for electricity and heat production in a Swedish municipal utility.

Unlike the desired approach for real-time optimization of facility operation, a number of approaches were published so far dealing with an off-line evaluation of optimal design and planning of distributed energy systems. One of such approaches, aiming at dimensioning and operation strategy selection for tri-generation plants, considering various operation parameters and energy tariffs, was proposed in [71] and [72]. In addition, several approaches for the optimal design and planning of distributed energy systems were proposed, such as for commercial buildings [73], large-scale energy supply systems [74] and multiple energy carrier systems [75], [76]. In addition, a linear programming cost minimisation model for high-level system design and the corresponding unit commitment of generators and storages within a micro-grid was developed in [77]. In [78], a cost optimal design of ice-storage cooling system in commercial building was determined under various electricity tariff schemes. In [79], optimal scheduling was investigated for a microgrid laboratory system, by targeting the minimisation of active power losses. In [80], a MILP model was developed, which minimises overall annual energy costs, by selecting the units to install and determining

their operating schedules. Another integrated MILP-based approach for the design, operation and evaluation of distributed energy systems was presented in [81], and applied in [82] for optimal system design at the neighbourhood level. A MILP model was also applied for the optimal operation of a virtual power plant, composed of intermittent renewable sources and storage units in [83] and [84]. Moreover, in [85], four approaches for modelling the thermal energy storage units with mixed-integer linear programs were introduced. A flexible decision support tool for energy management and environmental planning of regional-scale systems was presented in [86] and [87], and a general mathematical formulation of a multi-commodity energy-network flow model was described in [88]. At the same time, a number of approaches, investigating demand side optimisation, were analysed in the literature as well [89]-[94]. For instance, a decision support system, dealing with various load management scenarios, based on a neural networks methodology, was proposed in [89]. In [90], a decentralised control scheme that coordinates the actions of the end users was presented. A multi-objective genetic algorithm approach to implementing the DSM in an automated warehouse was investigated in [91]. Furthermore, a modified genetic algorithm was used in [92] to optimize the scheduling of direct load control strategies. An autonomous and distributed demand-side energy management system, based on game theory, was proposed in [93]. Finally, a novel autonomous demand response system that tries to achieve both optimality and fairness, with respect to the involved participants, was designed in [94]. In [95], a fuzzy logic approach, utilizing wireless sensors and smart grid incentives for load reduction in residential HVAC systems, was presented. Additionally, an integration of renewable energy sources and EVs with proper home demand-side management was evaluated through different scenarios in [96].

The underlying methodology employed by the μ GM's Optimisation engine aims at providing a holistic solution, integrating both energy supply side optimisation and demand side management to attain an improved degree of operation of the facility within the given constraints. Such an approach, i.e. integrating both supply and demand side management, has, in general, received somewhat less attention in the literature. For instance, contrary to the approach proposed in this thesis, which aims at real-time optimization at building level, the authors of [97] described a solution for off-line minimization of capital and operation costs for local utilities through CHP, heat storage

and electricity load management. In addition, solution in [97] introduced an irregular coarse-grained time division, excluding the possibility for higher resolution control. In [98] and [99], the so called Energy Hub (EH) model was used, in combination with the possibility of performing DSM for investment evaluation of utility infrastructure and district energy distribution infrastructure, respectively. Unlike the proposed approach, which was demonstrated in a real-world scenario, solution in [98] was validated by Monte Carlo simulations, whereby the tariffing prices were defined as random variables, while [99] evaluated different potential heating system configurations. For determining DSM constrains, more precisely of the heat load management, both [98] and [99] used a parameterized model of heated space, but in a simplified form, comparing to the proposed approach, which delivered estimation that is more accurate. Furthermore, in [100] an integrated DSM program for multiple EHs was proposed as a non-cooperative game within a cloud-based infrastructure. Contrary to the proposed approach, which actively takes into account the possibility of influencing the non-critical demand, integrated DSM program was demonstrated for EHs with critical loads hence optimizing only the supply for multiple EHs. Each EH was incentivized to participate the program, which required the exploitation of different supply energy carriers, thus affecting the overall energy-supply price value. The authors of [101] applied the EH concept for optimization of energy flows in simulated interconnected networks, but without taking into account the DSM actions. Finally, in [102] the authors evaluated the energy hub upon typical infrastructure of residential household by simulating different case studies, while the proposed solution was evaluated completely upon measured energy data and real pricing tariffs.

4.2. Proposed methodology for integrated optimization

With respect to the foregoing references, i.e. [97]-[102], the underlying methodology for μ GM Optimisation engine employs a conceptually similar approach, by jointly optimizing both the supply and demand side of a chosen energy system, where the latter is represented by an existing building complex equipped with operational on-site hardware and measuring devices. The heating dynamics of the building are explicitly modelled and employed to derive a suitable DSM constraint formulation, in terms of admissible thermodynamic requirements. A predictive optimal control algorithm is employed to minimize operating costs, and by using data and measurements from real-

life operating conditions, it is shown that simultaneously acting on both supply and demand can lead to a more advantageous operating profile over the selected temporal horizon. The overarching objective of the presented work is to illustrate that the employment of EM techniques, based on physical modelling and numerical optimisation, inherently exploits the degrees of freedom and interdependencies afforded by integrated energy infrastructure and effectively results in cost savings potential for a real world use-case.

4.2.1. Energy hub concept

The energy hub concept defines a framework for modelling energy infrastructure in a form that is amenable to and suitable for the formulation and solution of generic optimisation problems, by accounting for available energy carriers, power conversion potential and installed storage units. The selected modelling framework, based on [101], and used in [103] for the purpose of energy-hub investment analysis, is schematically featured in

Figure 14. The upper diagram refers to a single block representation of energy hub, which is the fundamental modelling unit corresponding to a sequence of stages representing input, conversion and output. Energy P_{in} enters into the hub at the input stage, where it is either stored as Q_{in} or directly dispatched (via the matrix F_{in}) as P_{cin} to the conversion block C . It is then possible to export output power P_{cout} delivered by the latter as P_{exp} , and then residual P_{out} is dispatched (via F_{out}) onto the output where it can be stored as Q_{out} or used to satisfy the demand L .

The above description refers to a single-block representation of energy hub, which already allows for the modelling of several and diverse energy assets. However, in order to account for other, possibly more complex or elaborate topologies, it is also possible to consider several such blocks in sequence, as shown in the lower diagram. The input to a successive block is taken to be equal to the output of the preceding block, so that for the two consecutive blocks the first sees the second as a load. Considering the flexibility and generality of such modelling approach, the hub concept can be applied to an entity, ranging from a single residence over a local microgrid up to an entire city or country.

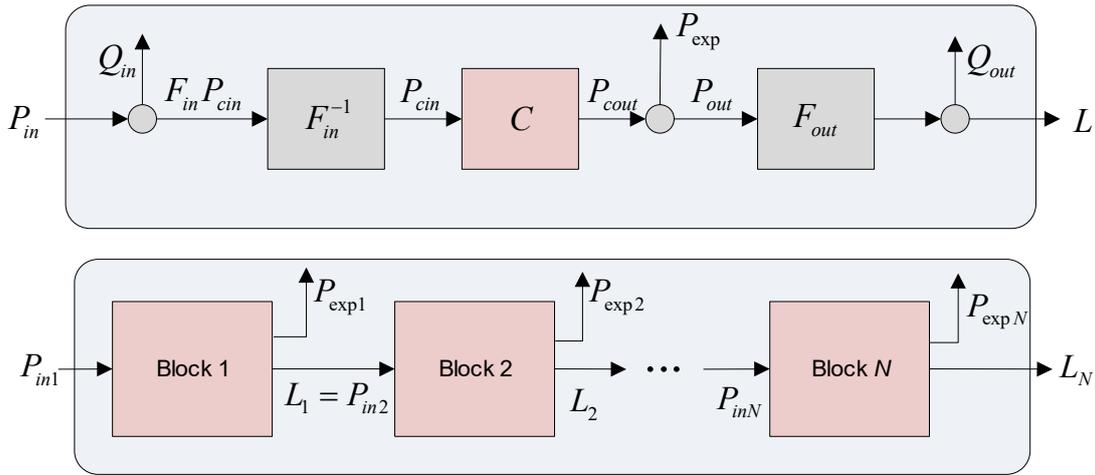

Figure 14: Block schematic of a single-block energy hub (up) and of sequential blocks (down)

4.2.2. μ GM integrated optimisation approach

The μ GM integrated optimization approach lies in the conceptual modification of energy hub to account for management of demand side flexibility to further improving operational performance of an energy infrastructure. Currently, different mechanisms are increasingly being used to act on the demand side and can broadly be considered as Demand Side Management (DSM) measures. The DSM, in general, represents any action associated with change on the demand side, focusing on achieving large-scale energy efficiency improvements by deployment and use of improved technologies and changes in end user behavior or energy practices. In other words, the DSM includes both conventional Energy Efficiency (EE) measures, as well as Demand Response (DR) mechanisms. The EE measures consider retrofit of all major energy consumers, i.e. replacement with more efficient ones, such as energy saving lighting devices, automated switch-off units, air conditioning units/circulation pumps, with improved coefficients of performance, more efficient boilers etc., which will be omitted from further elaboration. The DR, however, considers any action over existing energy consumers, resulting in the change of the overall load profile, which may include both load shifting and load curtailment, and will be directly addressed within the presented optimisation framework. In other words, DR measures represent any intentional modification of load profile by the end users from their common consumption pattern, reflecting changes of energy prices over time (e.g. peak and off-peak hours), or incentive programmes for stimulating lower energy use when system reliability is jeopardized. Lately, the concept is expanded

towards automated DR actions conducted by the power grid itself, naturally including prior end user consent. The objectives for introducing DR programs range from reduction of end user operation costs, over reduction of transmission and distribution losses, towards reduction of ecological and environmental impact, such as reduction of GHG footprint. To reach a predefined objective, load management can be formulated in a number of different ways, ranging from shifting the load profile in time, modifying its instantaneous levels, or altering its cumulative sum. Considering the nature of energy production and supply processes, any occurrence of peaks (or sudden drops) in the load profile usually incurs additional costs (i.e. surcharge not proportional to delivered energy) from the perspective of an energy provider. Bearing in mind that these costs are then passed on to the end customer, effectively avoiding or containing peaks by controlling, curtailing and/or shifting of the load, could result in significant savings in operational expenses. However, not all end-use applications are suitable for DR, so as a first step, it is necessary to identify and appropriately classify different types of loads. With respect to the aforementioned considerations, loads can be categorised according to the following breakdown [104]:

- critical load – should not be altered (typically power supply of fundamental operation),
- curtailable load – could be reduced (e.g. the temperature set-point of an air conditioning system could be lowered during periods of high electricity price, or if the stipulated peak consumption level is being approached),
- reschedulable load – could be shifted forwards or backwards in time (e.g. pre-cooling of a building can be performed early in the morning before there is an actual cooling demand).

Keeping in mind these categories, the identification of the curtailable and reschedulable loads is therefore a prerequisite to select and apply suitable DR measures.

The key to μ GM integrated optimisation lies in the merging of conventional supply optimisation approach with flexibility brought by the DR concept into a holistic energy management paradigm. Although the supply optimisation approaches alone can significantly reduce operation costs by optimizing the energy import, conversion and storage phases, it was challenging to investigate by how much performance can then be

further improved by acting on the demand side as well. To make the fair comparison, the constraint to keep the overall consumption constant is enforced. From the mathematical modelling perspective, joining of the two concepts is done by changing the nature of the loads from model parameters to model variables (i.e. values to be optimized), featuring a set of additional constraints, mainly related to the physical constraints of regular facility operation (e.g. required comfort levels), but also related to operating windows of each individual consumer.

4.3. Modelling and optimisation framework

4.3.1. Infrastructure modelling

4.3.1.1. Energy hub based infrastructure model

As introduced in previous section, the selected approach for development of energy-dispatch optimization framework is based on integrated optimization of both supply and demand side of so-called energy hub, depicted in

Figure 14. Its detailed mathematical representation and theoretical basis for optimization is given in the following chapters.

From the modelling perspective, the hub is represented as a matrix, which includes, in the most generic case, elements that enable conversion of various supply energy carriers to satisfy different load types. Furthermore, it also takes into account energy storages through an additional storage matrix, which maps different energy storage types associated with different energy carriers. From the modelling perspective, they act as energy buffers at the cost of storage efficiency. The energy carrier inputs to the system are denoted by P_{in} , which is an n -dimensional vector (for each discrete-time instant) whose entries contain the energy inflow according to the different possible carrier types (e.g. electricity from the grid, gas, solar energy etc.). These imports are then dispatched to the converters as power converter inputs P_{cin} to generate the power converter outputs P_{cout} , which are successively combined and/or exported to express how much energy P_{out} is effectively made available within the site and in which form. For example, the heating and cooling energy may be immediately used to serve the load, whereas the electrical energy can alternatively be temporarily stored in the battery. The relationships between the variables are presented in detail in the following. For all variables, the argument k denotes the value of the variable sampled at the k -th discrete-time instant kT_s in the

prediction horizon, where the sampling interval T_s is typically chosen with respect to the availability of fine grained measurements data and limitations induced by applicable pricing. The energy inflows into the system are decomposed as stored (Q_{in}) and dispatched (P_{cin}) energy according to:

$$P_{in}(k) = Q_{in}(k) + F_{in} P_{cin}(k) \quad (1)$$

so that F_{in} reflects how the different energy imports are dispatched to the conversion stage (each column in F_{in} represents an input to the converters units and each row corresponds to an energy carrier). Stored energy is further expressed as:

$$Q_{in}(k) = S_{qin} q_{in}(k) \quad (2)$$

where matrix S_{qin} is used to express the number of storage units, available for each carrier and q_{in} denotes the individual power flows, related to each of them. For each physical storage flow, contained in the vector q_{in} , there exists an energy variable representing the state of charge of the storage units, the values of which are stored in the vector E_{in} and for which the following relation holds:

$$\frac{E_{in}(k+1) - E_{in}(k)}{T_s} = q_{in}(k) \quad (3)$$

The matrix F_{in} describes how energy is sent to the converter units. For example, one energy carrier (e.g. electricity) might be used by a single converter (e.g. a transformer), whereas another (e.g. gas) might be used by multiple devices within the hub (e.g. a boiler and a CHP plant). Energy dispatched to the converters is then transformed according to:

$$P_{cout}(k) = C P_{cin}(k) \quad (4)$$

where the converter matrix C is expressed as diagonal matrix

$$C = \text{diag}(c_1, \dots, c_n) \quad (5)$$

and in which coefficients c_1, c_2, \dots, c_n express how much energy is delivered by the conversion process in relation to what the power inflow is. Then, a certain amount of energy can be exported to the network according to:

$$P_{out}(k) = P_{cout}(k) - P_{exp}(k) \quad (6)$$

where P_{exp} and P_{out} denote the exported and remaining (i.e. within the hub) energy amounts respectively.

Finally, the remaining power is delivered to the output stage, comprising the output storage Q_{out} and the load L according to:

$$L(k) = F_{out} P_{out}(k) - Q_{out}(k) \quad (7)$$

Stored energy is further expressed as

$$Q_{out}(k) = S_{q_{out}} q_{out}(k) \quad (8)$$

where matrix $S_{q_{out}}$ is used to express the number of storage units available for each carrier (for the hypothetical case, where there would be multiple storage facilities at the output) and q_{out} denotes the individual energy flows related to each of them. For each physical storage flow contained in the vector q_{out} there exists an energy variable representing the state of charge of the storage units, the values of which are stored in the vector E_{out} and for which the following relation holds

$$\frac{E_{out}(k+1) - E_{out}(k)}{T_s} = q_{out}(k) \quad (9)$$

Lastly, a classical load formulation is specified through:

$$L(k) = \bar{L} \quad (10)$$

or the case where L is a given (fixed) power demand profile, to be met for each operating period. However, by employing modern DR schemes, other formulations of this equation are needed. For example, a DR scheme may be accounted for and implemented as an energy constraint. This implies that the load need not be instantaneously equal to a fixed (power) value at each instant, but rather that a certain energy amount must be delivered over a pre-specified time period. This is achieved by setting a fixed interval $M+1$ for this purpose, and then imposing that

$$L(k) + L(k-1) + L(k-2) + \dots + L(k-M) = \hat{L} \quad (11)$$

in which \hat{L} is the given (i.e. forecasted) energy demand over the moving window, defined by the successive $M+1$ discrete time-instants. Notice that by setting $M=0$, the

formulation would be equivalent to a classic load constraint instantaneously fixing the demand, i.e. exactly satisfying the load profile. Other DR formulations are naturally possible, depending on the scheme, which it intends to implement.

The above expressions refer to the equalities, which describe the hub's topology and operational behaviour. The latter must be complemented with the relevant constraints, depicting hub's physical limitations, which can be described by inequalities. For example, range of any physical variable is bounded and the direction of power flows in the energy hub is usually constrained. To begin with, the inflow of power must obviously be positive, so that the inequality

$$P_{in}(k) \geq 0 \quad (12)$$

is also featured in the model. The power flow into the converters must furthermore be positive, so

$$P_{cin}(k) \geq 0 \quad (13)$$

as must be the output of the converters and the overall energy output, so that

$$P_{cout}(k) \geq 0, P_{out}(k) \geq 0 \quad (14)$$

are added. Lastly, constraints are also relevant for storage, since the amount of storable energy is limited, as is the rate of charge/discharge of the storage unit, meaning that

$$0 \leq E_{out}(k) \leq E_{out,max} \quad (15)$$

and

$$-Q_{out,max} \leq Q_{out}(k) \leq Q_{out,max} \quad (16)$$

Also, as an example, an elaborate energy pricing scheme, accounting for the maximum value of the electrical power intake from the grid, may be modelled with an auxiliary variable t , satisfying the following conditions

$$t \geq 0 \quad (17)$$

$$t \geq P_e(k), \forall k = 1 \dots N \quad (18)$$

where t represents an upper bound to the power absorbed from the grid. Then, when seeking to obtain an optimal solution, subject to the condition that the maximum power intake from the grid lie below a certain limit P_{lim} , the constraint

$$t \leq P_{lim} \quad (19)$$

should also be added, since t at optimality represents the maximum power absorbed from the grid.

4.3.1.2. Load model and DR scheme

As previously introduced, the load is no longer considered fixed, but rather a subject to variation, according to employed DR action. However, modification of load within a pre-specified period may have undesirable consequences for both the underlying end use, as well as for delivered comfort level, yielding further constraints, as modelled in the following.

First, in order to set the margins for load variation, an additional general inequality is defined as:

$$-\Delta L_{max}(k) \leq \Delta L(k) \leq \Delta L_{max}(k) \quad (20)$$

where $\Delta L(k)$ is the admissible deviation from a pre-computed classical load profile, defined at each instant k . Although recent approaches in load modelling feature greater utilization of knowledge about actual appliances and user habits, like in [105] and [106], the boundary values $\Delta L_{max}(k)$ must be determined, based on specific insight into, and knowledge about, the first principle modelling (i.e. building physics), criticality of demand and comfort requirements. Starting from electricity, one must perform a detailed load characterization (auditing), resulting in a breakdown into several categories, such as critical, curtailable and reschedulable loads, in order to be able to derive maximum allowed variations in the load profile. On the other hand, heating/cooling load reflects the amount of energy required to maintain a desired comfort level. Although comfort is, in general, defined by a number of parameters, such as temperature, humidity, air quality, etc., the analysis presented in the following will only consider the room temperature, since it is, in any case, the most influential parameter.

The change in the room temperature is caused by the two factors: building heat gains, associated with the conditioning system and solar irradiation (insolation), and building heat losses, caused by heat conduction, convection and ventilation. Obviously, the conditioning system is used to compensate for unwanted temperature variations and to maintain a desired set-point temperature. Furthermore, given that the selected use case does not feature any cooling load, the following elaboration focuses on the heating aspects, although considerations regarding the building physics are valid for both.

Starting off by assessing building heat gains, one can formulate the expression:

$$\Delta Q_{gains} = \Delta L_{heating} + \Delta Q_{insolation} \quad (21)$$

Heat gains related to insolation may, in principle, contribute significantly in the overall total. On the other hand, thermal energy losses are due to heat conduction and convection phenomena, as well as ventilation. Since ventilation systems are normally equipped with some kind of heat recovery unit, to prevent excess heat losses resulting from the air exchange, it is acceptable to consider only heat conduction and convection losses for the sake of simplicity. Given that different types of surfaces have different thermal conduction properties (e.g. walls, windows, roofing, etc.), the total building heat losses are calculated by summing partial heat losses, coming from each surface in the building. Following is a general heat loss equation:

$$\Delta Q_{losses} = \sum_{i=1}^N \left(\frac{\lambda_i \cdot A_i}{D_i} + h_i \cdot A_i \right) \cdot (T_{room} - T_{out}) \quad (22)$$

where index i is used to denote a particular surface, λ_i represents its thermal conductivity, h_i is its heat transfer coefficient, A_i is its conducting area, D_i is its thickness and T_{out} is the ambient temperature outside the building.

Another feature of buildings is referred to as thermal mass, which represents the ability to store internal energy. In the considered use case, energy is accumulated by the air inside the building (causing the increase of room temperature) as well as by surrounding surfaces, e.g. walls, windows, ceilings, etc., as defined in the following expression:

$$\Delta Q_{stored} = m_{air} \cdot c_{air} \cdot \Delta T_{room} + \sum_{i=1}^N (m_i \cdot c_i) \cdot \Delta T_{room} \quad (23)$$

where again index i is used to denote a particular surface, m_i and m_{air} represent the mass of each building surface and inside air, with their specific heat coefficients c_i and c_{air} , respectively.

Finally, the overall energy balance is derived by splitting the total heat gains into stored energy and total heat losses:

$$\Delta Q_{gains} = \Delta Q_{stored} + \Delta Q_{losses} \quad (24)$$

By combining 21-24, it is possible to derive a dependency between the heating load variation ($\Delta L_{heating}$) and room temperature deviation (ΔT_{room}) at each time instant k :

$$\Delta L_{heating}(k) = m_{air} \cdot c_{air} \cdot \Delta T_{room}(k) + \sum_{i=1}^N (m_i \cdot c_i) \cdot \Delta T_{room}(k) + \sum_{i=1}^N \left(\frac{\lambda_i \cdot A_i}{D_i} + h_i \cdot A_i \right) \cdot \Delta T_{room}(k) \quad (25)$$

4.3.1.3. Objective function

When it comes to definition of objective function for the overall optimisation problem, various technical, economic and environmental criteria can be defined. Being widely used, following is an example of a objective function definition for minimization of operational economic costs in the framework of pricing scheme, which accounts for consumed amount of energy but also the instantaneous power drawn from the power grid, which is a typical scenario for industrial/commercial consumers. Letting the value $\alpha(k)$ represent the cost per unit energy, the cost function

$$J = \sum_{k=1}^{k=N} \alpha(k) P_{in}(k) + \gamma P_{max} \quad (26)$$

is formulated to account for both the total energy inflows over a given horizon and the peak demand, corresponding to the highest electricity import from the grid, during the same horizon. Therefore, P_{max} is defined as the maximum value of P_e over the N discrete time-steps and the cost function J expresses the sum of overall energy purchases and the costs related to the maximal power P_{max} drawn from the grid. To present even more realistic scenario, power drawn from the power grid exceeding a given threshold value will be charged differently than the power consumed within the limits of a pre-defined

contract. For this purpose, parameter γ actually depends on the value that P_{max} attains over the considered optimisation horizon:

$$\gamma = \gamma_{low}, \text{ if } P_{max} < P_{lim} \quad (27)$$

$$\gamma = \gamma_{high}, \text{ if } P_{max} > P_{lim} \quad (28)$$

In other words, if the maximum grid power consumption exceeds a certain threshold P_{lim} then a penalty charge is applied, corresponding to the higher value of γ_{high} compared to γ_{low} . For imported electricity the cost per unit $\alpha(k)$ explicitly varies in time according to low/high tariff periods, and can accordingly be featured as a function of k .

The value P_{max} , however, is not explicitly featured in the model, as it is not known in advance, but rather a value to be reached throughout the operation time horizon. Therefore, it can be accounted for by reformulating (26) as

$$J = \sum_{k=1}^{k=N} \alpha(k)P_{in}(k) + \gamma t \quad (29)$$

where t is the auxiliary variable featured in (17)-(19). Minimizing (29) and (26), under the relevant model conditions and constraints, is equivalent, i.e. t at optimality is equal to P_{max} , because t is a positive variable that must always be bigger than P_e , so its feasible values are always above the maximum of P_e , whereas its optimal value (with respect to minimizing J) must be the maximum of P_e .

Furthermore, in order to address the issue of the binary nature of the cost related to the maximum grid power intake and its associated threshold, which breaks its linearity, the optimisation problem may be solved independently, with the condition that the maximum lays below the threshold and over the threshold, and by applying coefficients γ_{low} and γ_{high} , respectively. Alternatively, the problem may be changed to a mixed-integer one by adding another, binary, variable to account for the non-linear change in the consumed power penalization.

4.3.2. RET modelling

This section elaborates mathematical models, adopted by the μ GM system, used for simulation of operation of renewable energy sources, namely the solar photovoltaic panel and the wind turbine, combined electricity storage as accumulator battery, and the solar

thermal collector. The considered models represent the current state of the art adopted from the available literature. They represent deterministic models, driven by a set of meteorological variables and parameters depicting technical characteristics of each energy source/storage. The employed models are used for both μ GM system use cases, i.e. operation scheduling and energy planning. The difference lies in the input meteorological data that drive the models. In case of operation scheduling use case, it is necessary to obtain forecast of local energy generation and, therefore, the models are run with forecast of meteorological parameters, typically obtained from an external, usually open, service. On the other hand, the energy planning use case is focused on estimating long term performance assessment of a given energy infrastructure, comprising multiple renewable energy sources, and for this purpose it is required to obtain average energy harvesting potential for the location of the infrastructure, i.e. relevant historical values for the necessary meteorological parameters. Moreover, a relevant meteorological dataset should include averaged historical values, which are often referred to in literature as Typical Meteorological Year (TMY).

Given the objective of employed mathematical models, i.e. to serve for energy planning and operational scheduling at relatively low time resolution (e.g. from quarter-hour to one hour level), the complex dynamic models typically comprising differential equations for describing physical processes were replaced with simplified mathematical representations for performance estimation, use of manufacturers' datasheets and/or test procedures from the corresponding performance verification standards.

4.3.2.1. Solar-photovoltaic model

The following is a simplified model of solar photovoltaic panel, which takes into account efficiency of the cell, according to [107]. The employed model is driven by hourly sampled solar radiation and temperature data, but additional pre-processing of data is provided so as to account for different sampling rates. The expression below represents formula for estimation of photovoltaic panel output power as a product of four basic factors. The first depicts photovoltaic panel's rated capacity, as declared by the manufacturer. The second factor stands for the derating factor, used to model the effect of dust, snow, aging or other non-modelled parameters that affect the panel performance. The third factor represents dependency from the solar radiation, while the fourth accounts for impact of panel's temperature on its efficiency.

$$P_{PV} = Y_{PV} f_{PV} \left(\frac{\bar{G}_T}{\bar{G}_{T,STC}} \right) [1 + a_p (T_C - T_{c,STC})] \quad (1)$$

Where P_{PV} is the power output of the PV [kW], Y_{PV} is the rated capacity of the PV array, meaning its power output under standard test conditions [kW], f_{PV} is the PV derating factor [%], \bar{G}_T is the solar radiation incident on the PV array in the current time step [kW/m²], $\bar{G}_{T,STC}$ is the incident radiation at standard test conditions [kW/m²], a_p is the temperature coefficient of power [%/°C], T_C is the PV cell temperature in the current time step [°C], $T_{c,STC}$ is the PV cell temperature under standard test conditions [25 °C]. It should be noted that parameter a_p is negative given that power output decreases with increase of panel's temperature. It is typically provided by the manufacturer, or it may be calculated from the provided power/temperature curve. Some product brochures do not specify the temperature coefficient of power, but do specify the temperature coefficient of the open-circuit voltage. In such cases, the following expression is used to estimate the value of a_p :

$$a_p \approx \frac{\mu_{V_{oc}}}{V_{mp}} \quad (2)$$

Where $\mu_{V_{oc}}$ is the temperature coefficient of the open-circuit voltage [V/°C], V_{mp} is the voltage at the maximum power point under standard test conditions [V].

Calculation of the solar radiation incident on the PV array

The incident solar radiation \bar{G}_T featured in equation (1) combines several components of solar radiation together with incident angle. Namely, it is calculated based on the global, beam and diffuse solar radiation of the location together with parameters depicting orientation of the panel, using the expression from [108] as follows:

$$\bar{G}_T = (\bar{G}_b + \bar{G}_d A_i) R_b + \bar{G}_d (1 - A_i) \left(\frac{1 + \cos \beta}{2} \right) \left[1 + f \sin^3 \left(\frac{\beta}{2} \right) \right] + \bar{G}_g \rho_g \left(\frac{1 - \cos \beta}{2} \right) \quad (3)$$

Where \bar{G}_d is the diffuse radiation [kW/m²], \bar{G}_b is the beam radiation [kW/m²], A_i is the anisotropy index, R_b is the ratio of beam radiation on the tilted surface to beam radiation on the horizontal surface, f is the horizon brightening factor.

Since the employed model uses only global horizontal radiation as input, both beam and diffuse components of the radiation have to be estimated, as detailed in the following. The first step is to calculate extra-terrestrial normal radiation according to the following expression:

$$G_{on} = G_{sc} \left(1 + 0.033 \cos \frac{360n}{365} \right) \quad (4)$$

Then, follows the calculation of solar declination (δ), a factor depending on the earth's position with respect to the sun (B) and finally the so-called equation of time (E), as follows:

$$\delta = 23.45^\circ \sin \left(360^\circ \frac{284+n}{365} \right) \quad (5)$$

$$B = 360^\circ \frac{(n-1)}{365} \quad (6)$$

$$E = 3.82(0.000075 + 0.001868 \cdot \cos B - 0.032077 \cdot \sin B - 0.014615 \cdot \cos 2B - 0.04089 \cdot \sin 2B) \quad (7)$$

In order to calculate the solar time (needed both at the beginning and in the end of the time step), the following expression is used:

$$t_s = t_c + \frac{\lambda}{15^\circ / hr} - Z_c + E \quad (8)$$

Where t_c is the civil time in hours [hr], and t_s is the solar time [hr].

Finally, calculation of the hour angle at the beginning and end of each time step is calculated as follows:

$$\omega = (t_s - 12hr) \cdot 15^\circ / hr \quad (9)$$

The entire above are needed for the calculation of:

$$\bar{G}_o = \frac{12}{\pi} G_{on} \left[\cos \varphi \cos \delta (\sin \omega_2 - \sin \omega_1) + \frac{\pi(\omega_2 - \omega_1)}{180^\circ} \sin \varphi \sin \delta \right] \quad (10)$$

Where \bar{G}_o is the extra-terrestrial horizontal radiation averaged over the time step [kW/m²], ω_1 is the hour angle at the beginning of the time step [°], ω_2 is the hour angle

at the end of the time step [°]. Following is the expression for the calculation of the so-called clearness index:

$$k_T = \frac{\overline{G}}{G_o} \quad (11)$$

Using the clearness index, the following expression is used to calculate the \overline{G}_d :

$$\frac{\overline{G}_d}{\overline{G}} = \begin{cases} 1.0 - 0.09 \cdot k_T & \text{for } k_T \leq 0.22 \\ 0.9511 - 0.1604 \cdot k_T + 4.388 \cdot k_T^2 - 16.638 \cdot k_T^3 + 12.336 \cdot k_T^4 & \text{for } 0.22 < k_T \leq 0.80 \\ 0.165 & \text{for } k_T > 0.80 \end{cases} \quad (12)$$

and from the following expression, the \overline{G}_b is calculated:

$$\overline{G} = \overline{G}_b + \overline{G}_d \quad (13)$$

Given the above, the following parameters are calculated as well:

$$A_i = \frac{\overline{G}_b}{G_o} \quad (14)$$

$$f = \sqrt{\frac{\overline{G}_b}{\overline{G}}} \quad (15)$$

To calculate the angle of incidence ϑ [°], the following is used:

$$\begin{aligned} \cos \vartheta = & \sin \delta \sin \varphi \cos \beta - \sin \delta \cos \varphi \sin \beta \cos \gamma \\ & + \cos \delta \cos \varphi \cos \beta \cos \omega + \cos \delta \sin \varphi \sin \beta \cos \gamma \cos \omega \\ & + \cos \delta \sin \beta \sin \gamma \sin \omega \end{aligned} \quad (16)$$

Where ω [°] is the hour angle in the middle of time step. Similarly, the zenith angle ϑ_z [°] is derived from:

$$\cos \vartheta_z = \cos \varphi \cos \delta \cos \omega + \sin \varphi \sin \delta \quad (17)$$

and hence:

$$R_b = \frac{\cos \vartheta}{\cos \vartheta_z} \quad (18)$$

Calculation of the PV cell temperature

$$T_c = T_a + G_T \left(\frac{\tau a}{U_L} \right) \left(1 - \frac{\eta_c}{\tau a} \right) \quad (19)$$

where τ is the solar transmittance of any cover over the PV array [%], a is the solar absorptance of the PV array [%], η_c is the electrical conversion efficiency of the PV array [%], U_L is the coefficient of heat transfer to the surroundings [kW/m²°C]. The product $\tau a = 0.9$ is considered constant. Given that it is difficult to measure the value of $(\tau a / U_L)$ directly, manufacturers report the nominal operating cell temperature (NOCT), which is defined as the cell temperature that results at an incident radiation of 0.8 kW/m², an ambient temperature of 20°C, and no load operation (meaning $\eta_c = 0$). One can substitute these values into the above equation and solve it for $\tau a / U_L$ to yield the following equation:

$$\frac{\tau a}{U_L} = \frac{T_{c,NOCT} - T_{a,NOCT}}{G_{T,NOCT}} \quad (20)$$

Where $T_{a,NOCT}$ is the ambient temperature at which the NOCT is defined [20°C], $G_{T,NOCT}$ is the solar radiation at which the NOCT is defined [0.8 kW/m²].

For the η_c , it is assumed that the cell efficiency is always equal to the maximum power point efficiency $\eta_c = \eta_{mp}$, where η_{mp} is the efficiency of the photovoltaic panel at its maximum power point [%]. The following expression calculates η_{mp} as:

$$\eta_{mp} = \eta_{mp,STC} [1 + a_p (T_c - T_{c,STC})] \quad (21)$$

Where $\eta_{mp,STC}$ is the maximum power point efficiency under the standard test conditions [%], $T_{c,STC}$ is the cell temperature under standard test conditions [25°C]. To calculate $\eta_{mp,STC}$, the following expression is used:

$$\eta_{mp,STC} = \frac{Y_{PV}}{A_{PV} G_{T,STC}} \quad (22)$$

where $G_{T,STC}$ represents the solar radiation at standard test conditions [1 kW/m²].

Combining the above one can rewrite the T_c calculation expression as:

$$T_c = \frac{T_a + (T_{c,NOCT} - T_{a,NOCT}) \left(\frac{G_T}{G_{T,NOCT}} \right) \left[1 - \frac{\eta_{mp,STC} (1 - a_p T_{c,STC})}{\tau a} \right]}{1 + (T_{c,NOCT} - T_{a,NOCT}) \left(\frac{G_T}{G_{T,NOCT}} \right) \left(\frac{a_p \eta_{mp,STC}}{\tau a} \right)} \quad (23)$$

4.3.2.2. Wind turbine model

The employed wind turbine model estimates the power output based on the power curve, supplied by a turbine manufacturer, as follows

$$P_{WT} = P_{pc} \cdot \frac{\rho}{\rho_0} \quad (24)$$

where P_{WT} is the output power of the wind turbine [kW], P_{pc} is the output power of the wind turbine as calculated from its power curve [kW], ρ is the air density [kg/m³], ρ_0 is the air density under standard conditions (sea level, 15 °C) [kg/m³]. To be able to query the power curve, one must know the exact wind speed at the turbine hub height. Since the wind speed measurements are typically made at some standard height, the speed at hub height is estimated according to either of the following approaches, the power law profile and the logarithmic profile.

The logarithmic profile (or log law) assumes that the wind speed is proportional to the logarithm of the height above ground. The following equation therefore gives the ratio of the wind speed at hub height to the wind speed at anemometer height:

$$\frac{v(z_{hub})}{v(z_{anem})} = \frac{\ln(z_{hub} / z_0)}{\ln(z_{anem} / z_0)} \quad (25)$$

Where $v(z_{hub})$ is the wind speed at the hub height of the wind turbine [m/s], $v(z_{anem})$ is the wind speed at anemometer height [m/s].

The power law profile assumes that the ratio of wind speeds at different heights has power dependency, as defined by the following expression:

$$\frac{v(z_{hub})}{v(z_{anem})} = \left(\frac{z_{hub}}{z_{anem}} \right)^a \quad (26)$$

Empirical research in fluid mechanics has shown that the power factor is equal to $1/7$ for turbulent flow over a flat plate. Wind speed researchers, however, have found that, in practice, the power law exponent depends on temperature, season, terrain roughness, and several other factors.

After calculating the actual wind speed at the hub height, one can use the turbine's power curve to calculate the P_{pc} . The power curve is provided as wind speed – power output pairs. An example is shown in the Table 3.

Air density ratio calculation

Normalization factor used to calculate the final output power (P_{out}) out of the value extracted from the power curve is represented by the air density ratio, calculated using the following expression:

Table 2: Surface roughness length

| Terrain Description | z [m] |
|-----------------------------|---------|
| Very smooth, ice or mud | 0.00001 |
| Calm open sea | 0.0002 |
| Blown sea | 0.0005 |
| Snow surface | 0.003 |
| Lawn grass | 0.008 |
| Rough pasture | 0.010 |
| Fallow field | 0.03 |
| Crops | 0.05 |
| Few trees | 0.10 |
| Many trees, few buildings | 0.25 |
| Forest and woodlands | 0.5 |
| Suburbs | 1.5 |
| City centre, tall buildings | 3.0 |

Table 3: Wind turbine power-curve example

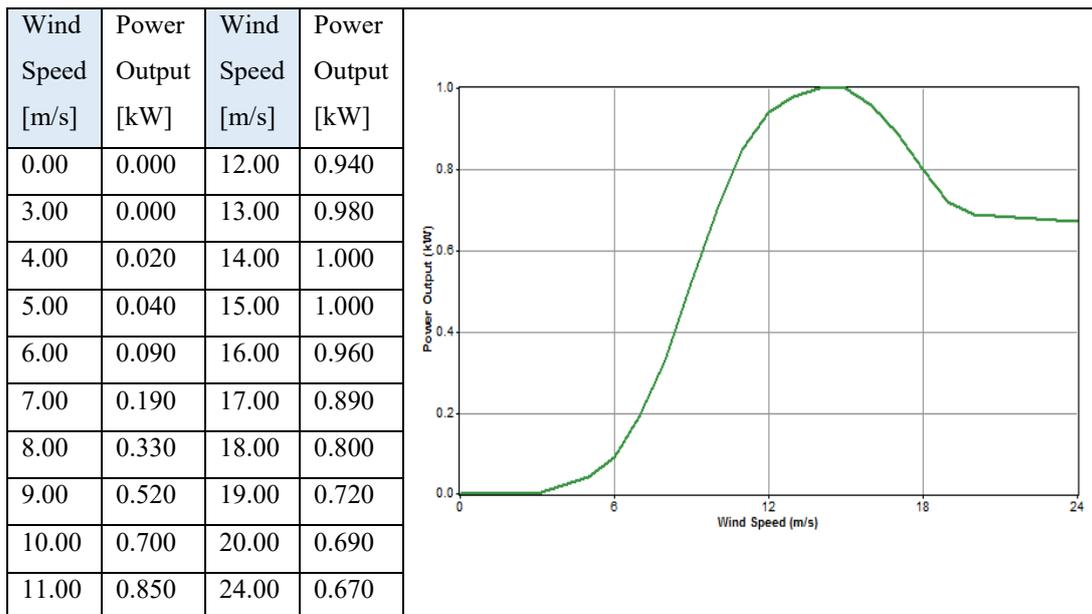

$$\frac{\rho}{\rho_0} = \left(1 - \frac{Bz}{T_0}\right)^{g/RB} \left(\frac{T_0}{T_0 - Bz}\right) \quad (27)$$

Where T_0 is the standard temperature [288,16 K], B is the lapse rate [0,00650 K/m], g is the gravitational acceleration [9,81 m/s²], R Gas constant / Mean molar mass for dry air [$R^*/M = 287$ J/kgK], z is the surface roughness length [m].

As depicted, the air density ratio depends, in fact, on a parameter that characterizes the roughness of the surrounding terrain. The Table 2, adapted from [109], depicts representative values for surface roughness length in different terrains.

4.3.2.3. Electricity storage model

Although the overall modelling framework can accommodate for different electricity storage technologies, the employed storage model is based on the accumulating battery storage. Before elaborating the battery model, one should consider the key parameter depicting battery status, which is called battery State of Charge (SOC) and is simply calculated as:

$$SOC = \frac{Q}{Q_{nom}} \quad (28)$$

where Q is the total amount of energy in the battery [kWh], Q_{nom} is the battery's nominal energy capacity [kWh]. Apart from the SOC, battery is normally characterized with its minimum SOC, which is the level below which the battery should not be drawn, typically a value between 30% and 50%. Therefore, this parameter is taken into account within the employed management strategy. Moreover, the employed battery model also takes into account lifetime throughput, which is the total amount of energy that can be cycled through the battery before it requires replacement, as well as its float lifetime, which is the maximum length of time that the battery will last before it needs replacement, regardless of how much or how little it is used. Finally, it should be highlighted that temperature effects on battery lifetime were not taken into account owing to the assumption that batteries are placed inside a conditioned building.

The kinetic battery model

The employed electricity storage model is based on the well-known Kinetic Battery Model [110], which models the battery as a two-tank system where the first represents the available energy and the second chemically bound energy. In order to estimate battery SOC, used by the energy management applications, the following expressions are used:

$$Q_{end} = Q_{1,end} + Q_{2,end} \quad (29)$$

$$Q_{1,end} = Q_1 e^{-k\Delta t} + \frac{(Qkc + P)(1 - e^{-k\Delta t})}{k} + \frac{Pc(k\Delta t - 1 + e^{-k\Delta t})}{k} \quad (30)$$

$$Q_{2,end} = Q_2 e^{-k\Delta t} + Q(1 - c)(1 - e^{-k\Delta t}) + \frac{P(1 - c)(k\Delta t - 1 + e^{-k\Delta t})}{k} \quad (31)$$

Where Q_{end} is the total amount of energy at the end of the time step [kWh], Q_1 is the available energy at the beginning of the time step [kWh], Q_2 is the bound energy at the beginning of the time step [kWh], $Q_{1,end}$ is the available energy at the end of the time step [kWh], $Q_{2,end}$ is the bound energy at the end of the time step [kWh], Q is the total amount of energy in the battery in the beginning of the time step [kWh], P is the power into (positive) or out of (negative) the battery bank [kW], Δt is the length of the time step [h], c is the battery capacity ratio, k is the battery rate constant [h^{-1}].

Although the previous expression defines, in principle, the change of battery charge based on the supplied, or drawn off, power, there are certain limitations, coming from battery characteristics which are elaborated in the following.

Calculating the allowable range for the power into or out of the battery bank

It is important to note that supplied power P is limited by the allowable range for the power going into or out of the battery bank. To calculate this range it is needed to calculate the maximum amount of power that the battery can absorb or discharge over a specific length of time using the following expression:

$$P_{batt,cmax} = \frac{MIN(P_{batt,cmax,kbm}, P_{batt,cmax,mcr}, P_{batt,cmax,mcc})}{\eta_{batt,c}} \quad (32)$$

Where $P_{batt,c,max}$ is the maximum battery charge power [kW], $P_{batt,c,max,kgm}$ is the maximum battery charge power limitation, due to the kinetic battery model [kW], $P_{batt,c,max,mcr}$ is the maximum battery charge power limitation, due to the maximum charge rate [kW], $P_{batt,c,max,mcc}$ is the maximum battery charge power limitation, due to the maximum charge current [kW] and $\eta_{batt,c}$ is the battery charge efficiency.

For the maximum amount of power that the battery can discharge over a specific length of time ($P_{batt,d,max}$) the next expression is used:

$$P_{batt,d,max} = \eta_{batt,d} P_{batt,d,max,kgm} \quad (33)$$

where $\eta_{batt,d}$ is the battery discharge efficiency, $P_{batt,d,max}$ is the maximum battery discharge power [kW], $P_{batt,d,max,kgm}$ is the maximum battery discharge power limitation due to the kinetic battery model [kW].

To calculate these power limits, at least two points (discharge rates) from the battery's capacity curve are needed. If more points are available, then the least squares fit can be used to find the best values for c and k parameters. An example of how the discharge rates are provided is shown in the Table 4. It is more convenient to normalize the discharge rates using a slow discharge rate. So:

Table 4: Battery storage manufacturer sheet

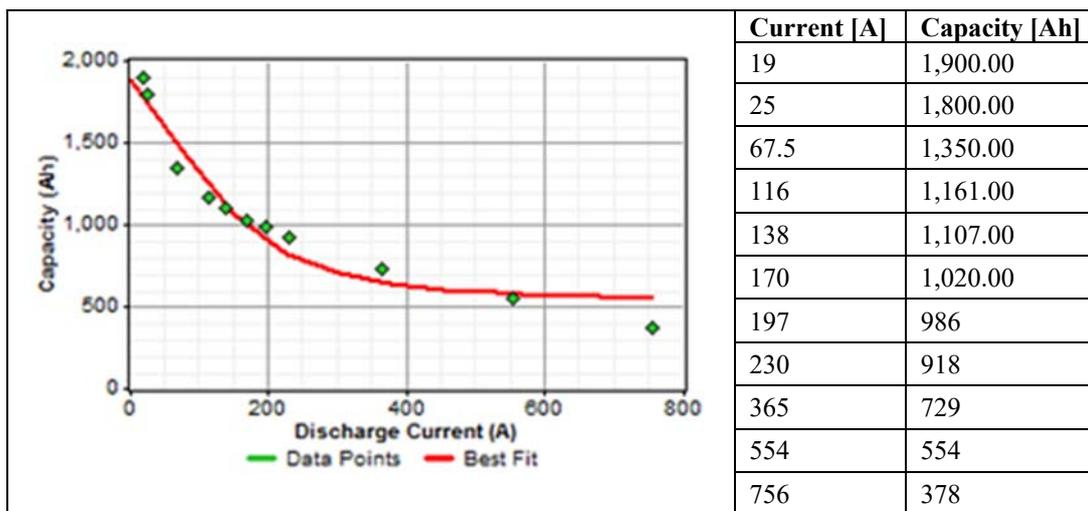

$$F_{t_1, t_2} = \frac{q_{T=t_1}}{q_{T=t_2}} \quad (34)$$

$q_{T=t_1}$ is the discharge capacity at the discharge time $T=t_1$ [Ah]. Using (at least) two given discharge rates, c and k are calculated using the expression:

$$c = \frac{F_t(1 - e^{-kt_1})t_2 - (1 - e^{-kt_2})t_1}{F_t(1 - e^{-kt_1})t_2 - (1 - e^{-kt_2})t_1 - kF_t t_1 t_2 + kt_1 t_2} \quad (35)$$

Where F_t is the F_{t_1, t_2} , t_1 is the chosen discharge time [h] and t_2 is the reference discharge time [h]. Then, the maximum (calculated) battery capacity is calculated using the following:

$$q_{\max} = \frac{q_{T=t} \left[(1 - e^{-kt}) (1 - c) + kct \right]}{kct} \quad (36)$$

Where q_{\max} is the maximum (calculated) battery capacity [Ah], t is a slow discharge time. If more values are available from the battery datasheet then a least-squares fit value could be used [h].

Finally, it is possible to calculate the maximum charge and discharge power according to kinetic battery model, maximum charge rate and maximum charge current. Starting with constraints, coming from kinetic battery model, the following is used:

$$P_{batt, cmax, kbm} = - \left(\frac{-kcQ_{\max} + kQ_1 e^{-k\Delta t} + Qkc(1 - e^{-k\Delta t})}{1 - e^{-k\Delta t} + c(k\Delta t - 1 + e^{-k\Delta t})} \right) \quad (37)$$

$$P_{batt, dmax, kbm} = - \left(\frac{kQ_1 \cdot e^{-k\Delta t} + Qkc(1 - e^{-k\Delta t})}{1 - e^{-k\Delta t} + c(k\Delta t - 1 + e^{-k\Delta t})} \right) \quad (38)$$

The maximum charge rate constraint is featured with following expression:

$$P_{batt, cmax, mcr} = \frac{(1 - e^{-a_c \Delta t})(Q_{\max} - Q)}{\Delta t} \quad (39)$$

where a_c is the battery's maximum charge rate [A/Ah], Q_{\max} is the total capacity of the battery bank [kWh].

And, finally, the maximum charge current constraint is defined by the next equation:

$$P_{batt,cmax,mcc} = \frac{N_{batt} I_{max} V_{nom}}{1000} \quad (40)$$

where N_{batt} is the number of batteries in the battery bank (for use if more batteries are connected in series), I_{max} is the battery's maximum charge current [A], V_{nom} is the battery's nominal voltage [V].

Both, the charge and discharge efficiencies, are based on the battery's round trip efficiency, $\eta_{batt,rt}$, typically assumed to be 80%, according to:

$$\eta_{batt,c} = \sqrt{\eta_{batt,rt}} \quad (41)$$

$$\eta_{batt,d} = \sqrt{\eta_{batt,rt}} \quad (42)$$

Finally, both the $P_{batt,cmax}$ and $P_{batt,dmax}$ can be calculated, which allows for calculation of the battery's SOC at the end of the time step. In case the battery is initially fully charged, the initial Q_1 is calculated as $Q_1 = c \cdot Q$.

4.3.2.4. Thermal solar collector

This following model aims to model domestic water heating system, employing a solar thermal collector and corresponding thermal energy storage, featured by a hot water tank. The employed modeling methodology is based on the valid International Standard ISO 9459-2:1995 (E), Part 2, which refers to 'outdoor test methods for system performance characterization and yearly performance prediction of solar-only systems, and on the analysis found in classic literature on the subject [111]. The term 'domestic' refers to residential or small commercial buildings. As written in the scope of the above standard, this part of ISO 9459 establishes test procedures for characterizing the performance of solar domestic heating systems, operated without auxiliary boosting, and for predicting annual performance in any given climatic and operating conditions with limitation of considering only the evening draw-off. The provided model is valid for all types of systems, including forced circulation, thermosiphon, freon-charged and integrated collector-storage systems. Moreover, it refers to solar-only domestic water heating systems, designed to heat potable water to be supplied for domestic water usage. Lastly,

the considered systems are not meant to use any supplementary energy, other than that required for fluid transport and control purposes.

The adopted methodology leverages standardized performance test procedure, used to predict the long-term output of the system for various values of solar irradiation, ambient air temperature, mains cold water temperature, load volume and hot water demand temperature, with accuracy of about $\pm 5\%$. Given that this test procedure, and the equations yielded from it, consider energy draw-off only during the night time, after a twelve-hour period of energy collection, they were modified accordingly, to allow for hourly and sub-hourly simulation of solar thermal system operation.

Energy production

Starting from the estimation of accumulated solar energy by the system, the following expression evaluates the amount of energy stored in the tank in approximately twelve hours period, according to the standard performance test procedure, as follows:

$$Q = a_1 H + a_2 (t_{a(day)} - t_{main}) + a_3 \quad (43)$$

The coefficients a_1 , a_2 and a_3 are determined from the standard test results, using the least-squares fitting method, where Q is useful (net) solar energy, gained by the storage tank during the day [MJ], H is daily solar irradiation in the collector aperture [MJ/m²], $t_{a(day)}$ is ambient air temperature [°C], t_{main} is cold water supply temperature [°C].

In addition, the test results related to the temperature increase [$t_{d(max)} - t_{main}$] of the water for various values of H and $(t_{a(day)} - t_{main})$ are represented by the following expression:

$$t_{d(max)} - t_{main} = b_1 H + b_2 (t_{a(day)} - t_{main}) + b_3 \quad (44)$$

Similarly, the coefficients b_1 , b_2 , and b_3 are determined from the test results, using the least-squares fitting method. The $t_{d(max)}$ refers to the maximum temperature of the water being drawn off [°C].

For the purpose of using previous expressions for hourly estimations, the following modification were made:

$$\begin{aligned}
 Q &= a_1 H + a_2 (t_{day}^{amb} - t_0^{tank}) + a_3 = \\
 &= a_1 \sum_{i=1}^{12} G_i T_s + a_2 \left(\frac{1}{12} \sum_{i=1}^{12} t_i^{amb} - t_0^{tank} \right) + a_3 = \\
 &= a_1 \sum_{i=1}^{12} G_i T_s + \frac{a_2}{12} \sum_{i=1}^{12} (t_i^{amb} - t_0^{tank}) + a_3 = \\
 &= \sum_{i=1}^{12} \left[a_1 G_i T_s + \frac{a_2}{12} (t_i^{amb} - t_0^{tank}) + \frac{a_3}{12} \right]
 \end{aligned} \tag{45}$$

where G_i is the solar radiation, t_i^{amb} ambient temperature and t_i^{tank} temperature of the water stored in the tank, at the i -th time step (hour). t_{day}^{amb} is average ambient temperature in the twelve hours period (day). On the other hand, the amount of energy stored in the tank in twelve hours period is equal to the sum of the amounts accumulated in each hour

$$Q = \sum_{i=1}^{12} Q_i \tag{46}$$

where Q_i represents amount of energy stored in the tank in i -th hour. It should be emphasized that one cannot simply assume $Q_i = a_1 G_i T_s + \frac{a_2}{12} (t_i^{amb} - t_0^{tank}) + \frac{a_3}{12}$ and should rather calculate Q_i in the same way as energy accumulated in twelve hours period

$$Q_i = b_1 H_i + b_2 (t_i^{amb} - t_{i-1}^{tank}) + b_3 = b_1 G_i T_s + b_2 (t_i^{amb} - t_{i-1}^{tank}) + b_3 \tag{47}$$

where b_1 , b_2 and b_3 are constants. The estimation of parameters b_1 , b_2 and b_3 is based only on the following:

- $b_1 = a_1$, because the amount of solar radiation on one squared meter of absorber area in one hour is $G_i T_s$, and the first term of the equations (45) and (47) represents the amount of energy extracted from sunlight.
- $b_3 = a_3/12$.
- Parameter b_2 should resemble $a_2/12$, but because of the ever changing temperature of the water in the tank in equation (47), instead of the fixed temperature in equation (45), it should be a bit larger. A numerical experiment has been conducted to estimate the coefficient b_2 , which minimizes mean square error of the energy evaluated by summing results of equation (47) repeated twelve times

(once for every hour), with respect to energy evaluated by equation (45). Based on this experiment, the coefficient b_2 is set to $b_2 = 4490.3$.

It is important to emphasize that the energy evaluated by equation (47) is the increment of energy in tank after one hour. The energy produced by thermal solar collector in that hour is the sum of that energy and energy lost from tank (Q_i^{lost} , which is described in future text) in the same hour.

$$Q_i^{produced} = Q_i + Q_i^{lost} \quad (48)$$

Energy losses

Following is the analysis of the heat loss process, continuously ongoing in the storage tank. The available literature experimentally estimates tank's heat loss coefficient U_s , based on water density ρ_w , specific heat capacity of water c_{pw} , tank's volume V_s , duration of the experiment ΔT , initial temperature of water in the tank, t_{init}^{tank} , final temperature of water in the tank t_{fin}^{tank} and the average ambient temperature for the duration of the experiment t_{av}^{amb} as:

$$U_s = \frac{\rho_w c_{pw} V_s}{\Delta T} \ln \left(\frac{t_{init}^{tank} - t_{av}^{amb}}{t_{fin}^{tank} - t_{av}^{amb}} \right) \quad (49)$$

The conducted experiment measures t_{init}^{tank} , lets the tank to cool for approximately twelve hours, measures t_{fin}^{tank} and t_{av}^{amb} and then calculates U_s with those values by using equation (49). This value is then used to calculate the amount of energy lost through the walls of the tank according to:

$$Q^{lost} = V_s \rho_w c_{pw} \left(t_0^{tank} - t_{av}^{amb} \right) \left(1 - e^{-\frac{U_s \Delta T}{V_s \rho_w c_{pw}}} \right) \quad (50)$$

which is equal to the sum of amounts of energy lost in each of twelve hours, calculated in the same way as Q^{lost} but with different parameters

$$Q^{lost} = \sum_{i=1}^{12} Q_i^{lost} = \sum_{i=1}^{12} V_s \rho_w c_{pw} \left(t_{i-1}^{tank} - t_{av}^{amb} \right) \left(1 - e^{-\frac{U_s T_s}{V_s \rho_w c_{pw}}} \right) \quad (51)$$

A numerical experiment has been conducted to estimate the parameter W_s , which minimizes mean square error of the energy evaluated by equation (51), with respect to energy evaluated by equation (50). Based on this experiment, the coefficient W_s is set to $W_s = 1.697768076505273$.

Model scalability

Finally, the existing mathematical model has been adjusted in terms of scalability in order to support an arbitrary system size. In the standard, the model is developed for a tank with 182-liter capacity and solar collector with absorber area spanning over 1.33 square meters. In order to develop model for any volume of the tank and for any value of absorber area of the collector, produced energy should be multiplied by the area of the actual collector's absorber and divided by 1.33. In addition, heat loss coefficient of the tank should be multiplied by the volume of the tank and divided by 182. The first scaling related correction is intuitive, whereas the second one is supported by equation (49), which indicates that heat loss coefficient is proportional with the volume of the tank. Of course, this holds only under the set of strict conditions, among which is the constancy of tank's shape, appropriate adjustment of tank's isolation thickness to the new volume, and so on, but due to the lack of more precise relationship between heat loss coefficient and volume, this approach is utilized. Also, the adopted model assumes that energy stored in tank is zero when the temperature of water in tank is the same as temperature of water in cold water supply. This assumption makes the model unusable in the overall μ GM simulation framework, because the cold-water temperature can vary. In order to overcome this problem, the adjusted model assumes that energy stored in tank is zero when the temperature of water in tank is zero °C.

Having set all the previous parameters, a mathematical model of the thermal solar collector, operating at one-hour sample time, is derived. In other words, an algorithm, which calculates the amount of energy in the tank, based on the user demand, energy already stored in tank and meteorological data, is established. The algorithm also calculates unmet demand, in case of energy extracted from sunlight being insufficient, and is defined in detail with the following steps:

1. Compute temperature in tank

$$t_i^{tank} = \frac{Q_i}{V_s \rho_w c_{pw}} + t_i^{cold\ water} \quad (52)$$

2. Evaluate energy produced by solar collector with absorber area of 1.33 square meters in i -th hour

$$Q_i^{(1.33)} = b_1 G_i T_s + b_2 (t_i^{amb} - t_{i-1}^{tank}) + b_3 - V_s \rho_w c_{pw} (t_{i-1}^{tank} - t_i^{amb}) \left(1 - e^{-\frac{W_s T_s}{V_s \rho_w c_{pw}}}\right) \quad (53)$$

3. Scale that value according to absorber area of the collector A_a

$$Q_i^{produced} = Q_i^{(1.33)} \frac{A_a}{1.33} \quad (54)$$

4. If this value is less than zero, than the collector would actually cool down the water, not heat it up, and should be cut off from the system for i -th hour, thus making produced energy

$$Q_i^{produced} = 0 \quad (55)$$

5. Compute energy lost in i -th hour

$$Q_i^{lost} = V_s \rho_w c_{pw} (t_{i-1}^{tank} - t_i^{amb}) \left(1 - e^{-\frac{W_s T_s}{V_s \rho_w c_{pw}}}\right) \quad (56)$$

6. Compute energy remained in the tank after meeting user demand

$$Q_i = Q_{i-1} + Q_i^{produced} - Q_i^{lost} - Q_i^{userdemand} \quad (57)$$

7. If computed energy is less than zero, then user demand cannot be met by using solar collector only and some auxiliary power source should be used as well.

$$\begin{aligned} Q_i^{auxiliary} &= -Q_i \\ Q_i &= 0 \end{aligned} \quad (58)$$

The previously elaborated model for solar thermal collector, and corresponding hot water tank, acting as thermal energy storage, is used by the μ GM simulation framework and, hence, the energy planning and operation scheduling applications. Model is obtained through measurements and curve fitting (described above), and not through analytical manipulation of differential equations. This makes one unable to incorporate sample period as parameter anywhere in the model, which further results in this model being valid for sample period of one hour only. Obtaining valid model for any other sample period requires repetition of whole process described above. Since expected sample period for model is relatively large (about one hour), an alternative approach is taken in

μ GM modeling. It is important to understand that the model is used for only one purpose in the μ GM system, which is to calculate amount of hot water and heating demand that this model can satisfy.

In case a sample period other than one hour is needed, the following steps were considered.

1. Model is run for sample time of one hour and the amount of hot water and heating demand that thermal solar collector can satisfy for every hour are computed.
2. Interpolation is applied to find values for this signal at the end of each time step.

It is important to emphasize that the process for obtaining parameters of the model by curve fitting and mean square error minimization, described above, was conducted with relatively small number of measurements from the project (Annex). Because of that, error made by this interpolation should be negligible, in comparison to error made by the process of obtaining model's parameters.

4.4. Software implementation

4.4.1. Prototype development

A prototype of the Optimisation engine was first developed in MathWorks®/Matlab® environment, based on the mathematical model, presented in Section 4.3.1.1. Given the provided representation of the energy hub, and featured energy dispatch problem, the employed optimisation approach considers both linear and non-linear techniques. Moreover, given that the non-linearity in hub formulation comes from optional use of binary variables (or integer, in general), the optimisation problem may be solved by employing Linear Programming (LP) or Mixed-integer Linear Programming (MILP) techniques.

In principle, any MILP optimisation problem is defined as:

$$\min_x f^T x \quad \text{s.t.} \quad \begin{cases} x(\text{int}) \text{ are integers} \\ A_{\text{ineq}} x \leq b_{\text{ineq}} \\ A_{\text{eq}} x = b_{\text{eq}} \\ lb \leq x \leq ub \end{cases} \quad (59)$$

where x represents a vector of variable to be optimised, int represents a vector of indices of x which are defined as integers, f represents a vector which defines the objective

function, A_{ineq} represents a matrix featuring inequality constraints, b_{ineq} represents a vector which defines boundaries for inequality constraints, A_{eq} represents a matrix featuring equality constraints, b_{eq} represents a vector which defines boundaries for equality constraints, lb and ub represent lower and upper boundaries for variables x .

Given the above formulation of optimisation problem, there is an abundance of solvers able to deliver optimum solution. Although Matlab framework itself offers an appropriate solver (functions `linprog` and `intlinprog`), it was decided that one of the industry standards IBM® ILOG® CPLEX® Optimizer should be used instead, owing to much better performance in case when the problem is significant in size. To illustrate the need for an efficient solver, one may consider a use case for Energy planning application, when optimisation is typically run for a time-horizon exceeding one-year period. In such case, the above matrix A_{eq} can reach the size of $10^6 \times 10^6$ for an average level of infrastructure complexity.

The major functionality of the developed Matlab prototype lies in the transformation of the hub model and corresponding operation constraints, featured by the equations given in Section 4.3.1.1, into the appropriate matrices and vectors, required by the employed solver. This process has been efficiently performed by exploiting the powerful `sparse matrix` and `vector` manipulation routines in Matlab. The developed Matlab prototype is characterized with following major functional parts:

- Energy infrastructure (hub) model: which represents piece of code devoted to energy hub model of the physical system topology, which is defined by the model matrices, i.e. the input storage matrix S_{gin} , input dispatch matrix F_{in} , conversion matrix C , output dispatch matrix F_{out} , output storage matrix S_{gout} , as elaborated in Section 4.3.1.1.
- Input parameters and pre-processing: which depicts the part where parameters needed for the formulation of the optimisation problem are defined. This entails technical characteristics of energy assets featured in the hub, namely the conversion units and storage devices, but foremost the parameters such as base load profile, local renewable energy generation, applicable energy pricing scheme for both import and export etc., which are stored as time series or read from corresponding files. This part is also devoted to all pre-processing of data, such as

adaptation of meteorological data, building price profiles out of the given pricing scheme, estimation of local energy production etc.

- Optimisation problem definition: which represents section where the previously defined hub model and associated parameters are used to assemble the key A_{eq} and A_{ineq} matrices, requiring complex linear algebra operations. Finally, once the matrices and corresponding vectors are defined, the optimisation problem is transferred to the solver and appropriate optimisation routine is called to execute the optimisation.
- Solution post-processing: which is the part where, in case an optimal solution is returned by the optimisation routine, the acquired solution is processed. This entails calculation of pre-defined set of key performance indicators (KPIs) out of the raw optimised variables.

4.4.2. Software application

Following the development of Optimization engine prototype in the Matlab environment, and achieving positive results, regarding the proposed methodology of integrated optimisation of supply and demand side, the objective was to implement the same engine using suitable technologies for its deployment in the μ GM's service oriented environment. Considering the choice to use open-source technologies for the entire software system, the majority of system's business logic was developed in Java language, while fully adopting the object-oriented paradigm. The same choice was made also for the Optimization engine.

Before going into detail about the Java implementation, the possibility to use existing Matlab code and integrate it within Java application is worth noting. This is possible with the use of Matlab Builder JA™, which is able to generate Java classes out of the Matlab source code. In addition, it should be highlighted that the resulting Java classes can be integrated into Java applications and deployed royalty-free, without installation of Matlab environment, but only by using the Matlab Compiler Runtime™ (MCR). However, the existing Java enable solvers have somewhat different architecture than the ones available for Matlab and require complete restructuring of the underlying optimisation problem. Moreover, the tested performance of compiled Matlab code within Java environment is

far from the native Java application. Therefore, following is an overview of the original application developed in Java.

The Optimization engine, featured in the μ GM system, is in fact a Java application, developed under Integrated Development Environment (Eclipse Java EE IDE - Juno Service Release 2), using Java Enterprise Edition 7 (Java EE 7). Moreover, considering the service oriented deployment environment, the developed Java classes have been wrapped in a web service, which is further elaborated in the following text. The UML class diagrams depicted in Figure 15 represent the design of Optimization engine in Java. The figure shows six classes that implement the core business logic, as follows:

- `class Hub`: models the topology of an energy hub by defining corresponding matrices and necessary parameters.
- `class Parameters`: stores system parameters or generates artificial data for various time variable input parameters such as production from renewables, energy pricing, load profiles etc., which enables testing of the module itself, but also provides opportunity to conduct sensitivity analysis of the proposed design solution.
- `class OperationOptimization`: implements the energy dispatch optimization of a particular hub configuration. It uses the mathematical representation of hub and corresponding parameters to model its behaviour over a given time span as LP or MILP problem. Furthermore, in order to be able to run the CPLEX optimizer, modelling was performed using the appropriate API and interfaces, as elaborated further in the text.
- `class DesignOptimization`: implements the design optimization as multiple concentric loops going over different combinations of corresponding energy asset alternatives (namely different energy sources and storages), which are then used to run corresponding energy dispatch optimization.
- `class OptimisationResults`: stores the optimisation solution and processes the output, by reshaping the one dimension vector into corresponding matrices, to deliver raw data.
- `class KPI` – responsible for post-processing of the optimization results and calculation of corresponding Key Performance Indicators (KPIs), out of the raw

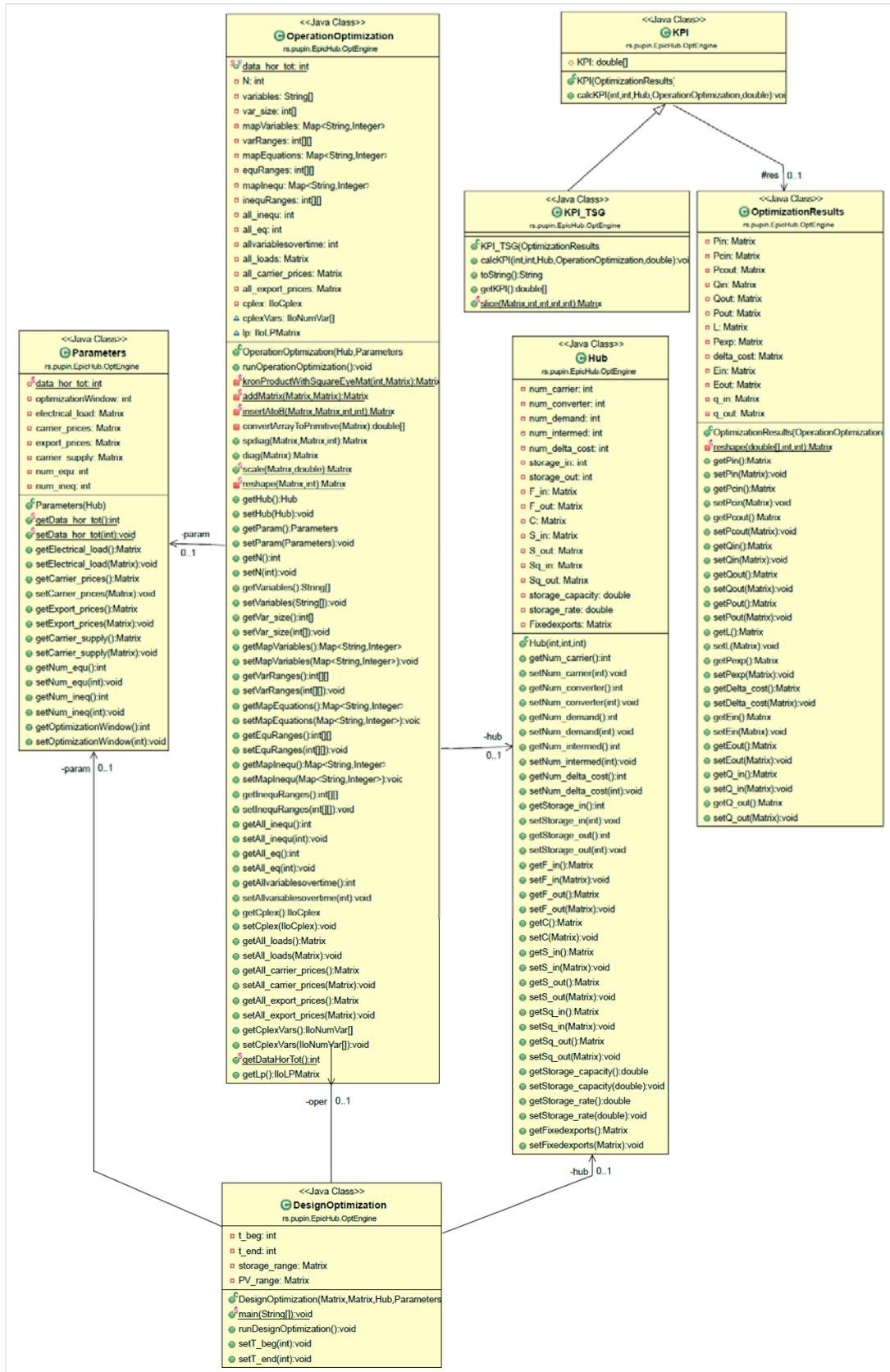

Figure 15. Optimization engine UML class diagram

data, to be used for evaluation of different alternatives. The class `KPI_TSG`, represented in the same figure, is in fact the child class of the class `KPI`, which is used to calculate indicators for a specific case.

To deliver described functionalities, the above listed classes leverage external components, other than the Java System Library:

The CPLEX API - Similarly as for the development of the Matlab prototype, CPLEX was used as a solver in the Java environment as well. Using CPLEX in Java environment is, however, a bit more complex and requires utilization of a specialized Application Program Interface (API), which allows Java applications to call CPLEX directly, through the Java Native Interface (JNI). As depicted in Figure 16, the Java interface is built on top of ILOG Concert Technology for Java and supplies a rich functionality allowing use of Java objects to build an optimization model¹⁴. The available library offers suitable API, that provides a set of interfaces and classes that enable typical CPLEX features such as creating a model, solving the model, querying results after solving, and handling error conditions in Java environment. In other words, it allows seamless way for developers to embed CPLEX optimizer in Java applications. The supplied API, however, requires complete restructuring of the optimisation problem definition according to its key classes:

- `class IloNumVar`: used for modelling of problem variables
- `class IloRange`: used for formulation of ranged constraints

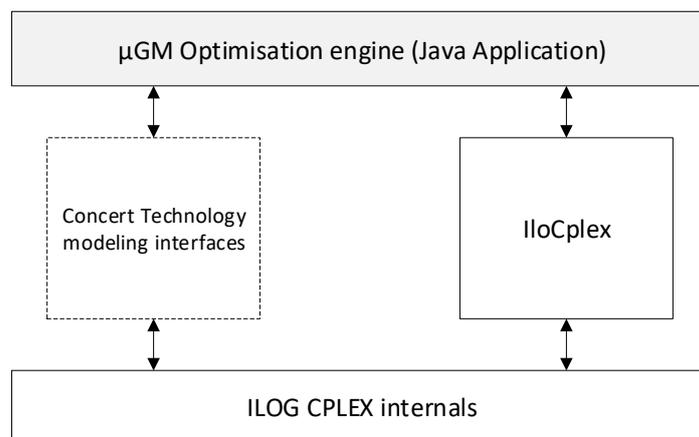

Figure 16. IBM ILOG Concert Technology for Java

¹⁴ Adapted from IBM CPLEX Optimization Studio,[link/](#)

- `class IloObjective`: used for definition optimization objective
- `class IloNumExpr`: used for definition of equations employing variables

The CPLEX core engine - It represents implementation of CPLEX optimization engine in a dynamic linked library (.dll) which is required to run Java applications that use CPLEX. In fact, this lightweight .dll replaces the entire ILOG CPLEX Optimization Studio and allows for compact application design. Although there are available, open source, solver solutions, the CPLEX was chosen owing to its unprecedented performance and royalty-free availability through an Academic Licence.

The Matrix library – It represents a native Java library that provides Linear Algebra primitives (matrices and vectors) and manipulation algorithms. Given the overall hub model and optimisation problem formulation leverage matrix representation, employment of a suitable Linear Algebra library, offering definition and manipulation with sparse matrices was of critical importance. For this purpose, an open-source Java library called *La4J* was chosen, owing to its ability to manipulate the extremely large matrices, through its implementation of the sparse matrix concept. This feature enables efficient manipulation of the oversized sparse matrices, having approximately 10^6 rows and columns. The *La4J* library was selected, based on the exhaustive investigation and benchmarking of group of libraries with similar features comprising: *Commons_math*, *Colt*, *Ojalgo*, *JBlas*, *EjML*, *MtJ*, *Jeigen/Eigen* and *La4J*.

4.4.3. Integration and deployment within μ GM system

This section aims at briefly discussing the deployment and integration aspects of the previously elaborated Optimization engine within the μ GM environment. As discussed within Section 2 (Energy Management Application Layer), the described Optimization engine represents a core application on top of which the end user applications *Operation scheduling* and *Energy planning* are built. In other words, these applications are acting as a wrapper for optimization engine and are focusing on the two different use cases, i.e. planning optimization and operation optimization). Furthermore, these applications are devoted to gathering relevant user inputs, collecting necessary data from the system (e.g. collecting production forecast or accessing external service for energy pricing), performing appropriate pre-processing of data, running the Optimization engine for the

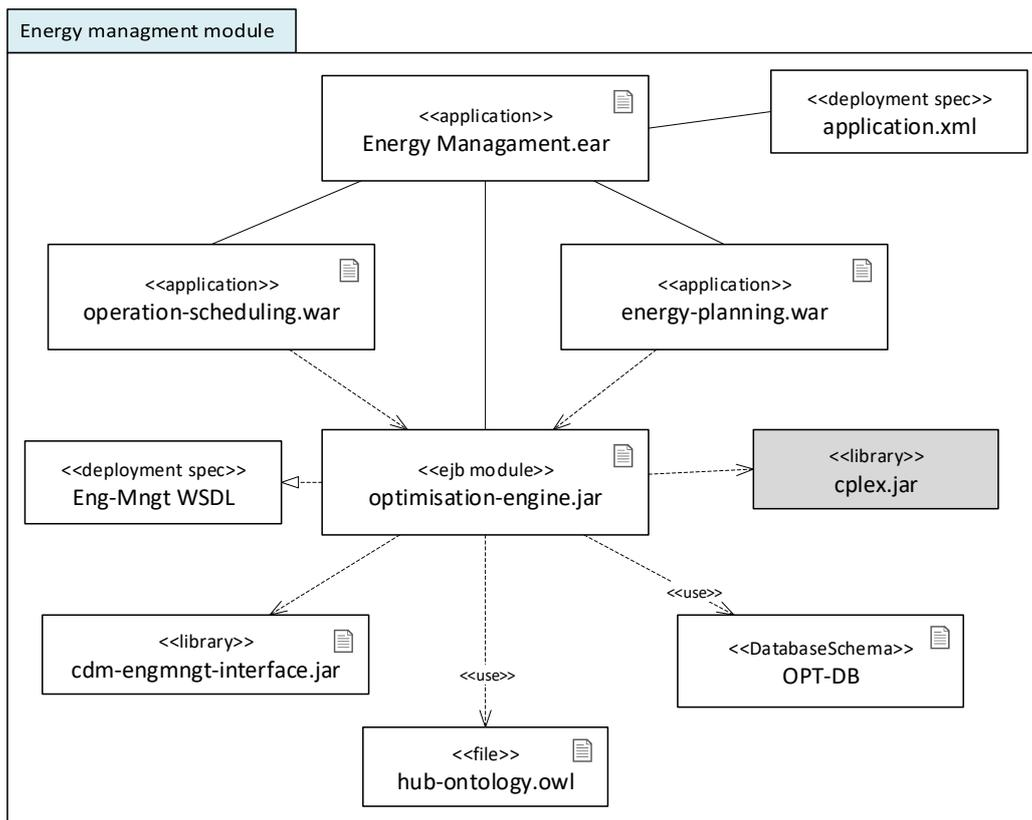

Figure 17: Energy management module – component diagram

desired use case and, finally, prompting the user with the desired output, after appropriate processing of optimization results. A detailed elaboration on the development of these two end user applications is, however, out of the scope of this thesis, given their limited scientific impact.

The Energy management module, which encompasses both Operation scheduling and Energy planning and underlying Optimization engine, has been developed as a Java Enterprise Application (EAR) with the following components being part of the module, as depicted in Figure 17:

- Web application (WAR file, Web application ARchive): which is used to implement the user interface for the Energy planning application, offering configuration and management of the Optimization engine. The Web application collects the following components (bundled in a WAR file): HTML pages, JSP pages, servlets, utility classes, libraries and other resources (e.g. deployment descriptors as web.xml and sun-web.xml).

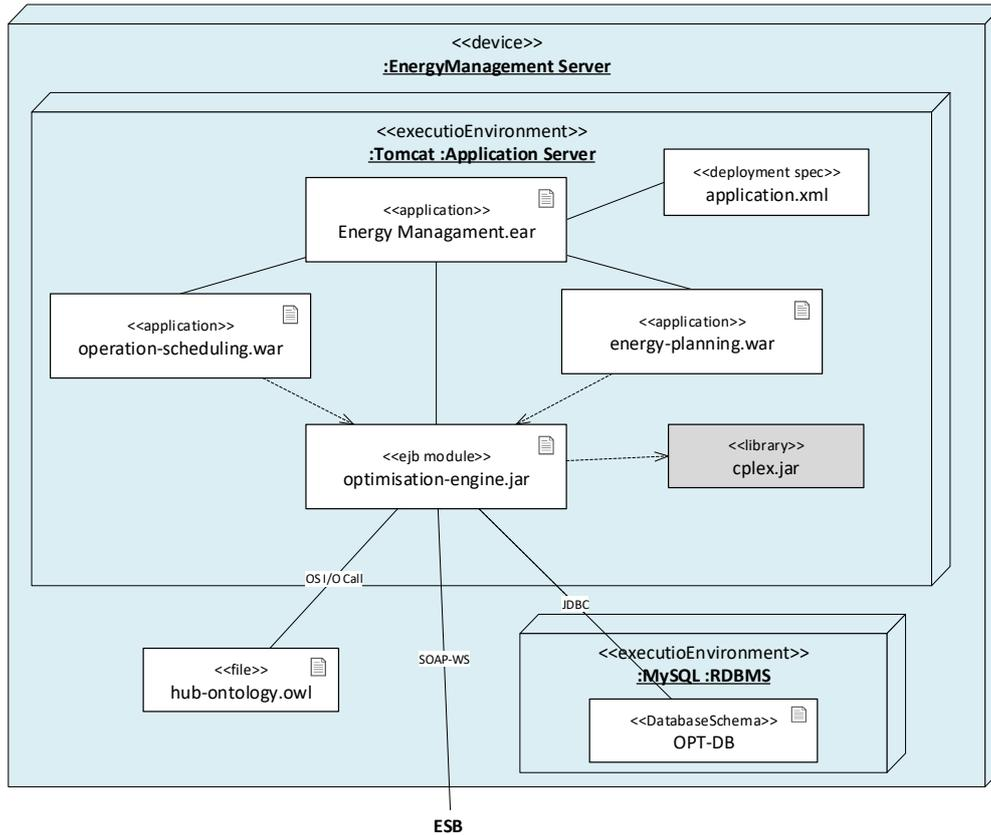

Figure 18: Deployment of Energy management module as a single EAR application

- EJB (Enterprise Java Bean) module (JAR file, Java ARchive): which is devoted to the implementation of application’s business logics, Optimization engine, but also other aspects beyond the optimization. As highlighted previously, both Energy management applications (Energy planning and Operation scheduling) use the same logic (EJB), while the nature of inputs and objectives implement different use cases. Each EJB JAR contains:
 - o Enterprise Java Beans (EJB) representing the core of the business layer (business logic and persistence management);
 - o Java Beans to manage the data flow between the application layers;
 - o Data Access Objects (DAO) to communicate with the database and in general manage the information persistence;
 - o Java classes providing utilities to the application.
- OWL ontology: which stores the contextual μ GM knowledge about the system and is used to manage semantics used in the optimization process through a Java API, such as Apache Jena.

- Supporting relational Database: which manages additional data and information used by the module (e.g. user authentication, configuration parameters of the simulation engine, hub topology, nodes attribute, etc.).

The *Optimization engine* module receives all necessary data from the middleware through different methods/operations. It can be either subscribed to a particular topic, e.g. to receive regular updates about real-time measurements, or request specific information from a corresponding component. In both cases, communication with other system components is compliant with the Canonical Data Model (CDM) definition and proposed *Comet* approach, based on WSDL/SOAP services. The SOAP WS interface defined by the μ GM CDM identifies all the services and methods used by the Middleware and by the Energy management component to interact. Finally, the Figure 18 depicts deployment of Energy management module as a single EAR application on a given application server (i.e. Tomcat server).

5. Planning service for multi-criteria design/retrofit of hybrid microgrid

This section elaborates the development of μ GM's Energy planning application, which aims at providing system end user with a decision support tool for optimal microgrid design and retrofit. In other words, it focuses on delivering recommendation about the most suitable topology of energy assets and their corresponding sizes, against a range of parameters, either set by the user himself, or determined according to the context (geographical, market, environmental) in which the future system, or retrofit, is to be deployed. To illustrate the need for a structured approach and an elaborate design methodology, one may first consider several factors influencing the planning of a hybrid microgrid, which may, in principle, comprise different conventional and renewable energy sources, energy conversion assets as well as energy storage units:

- Geographical context: on-site energy production from renewables, especially from wind and solar photovoltaic units, is governed by the availability of the primary energy source and the harvesting potential for a given geographical location.
- Microgrid deployment options and underlying business model: microgrid can operate in several utterly different modes such as grid-tie, isolated (island), near-zero energy, positive energy etc.
- Energy policy and market conditions: existence of governmental incentives in the form of tax reductions for particular energy sourcing equipment, or feed-in tariffs for guaranteed energy export prices.
- Energy demand requirements: seasonal energy use patterns for workdays, weekends, holidays, etc. (e.g., required indoor temperature, the frequency and intensity of appliance operation).
- Multi-criteria design: involves various, often confronted, technical, environmental, economic and societal criteria.

The stated challenge of microgrid design boils down to deciding on the optimal microgrid topology, i.e. particular type of energy sources, converters, storages to be involved, and the sizing of each involved energy assets, in terms of its rated power, throughput and capacity respectively. Although these aspects seemingly represent independent problems,

suitable for sequential resolving, in fact they are very much connected and ought to be jointly considered. Moreover, the design criteria are typically driven and dependent on a given microgrid deployment scenario. For example, in case of an isolated microgrid one might seek to minimize the loss of power supply probability (LPSP) whereas for a grid-tied power plant scenario it may be to maximize the net profits or, in the case of residential microgrid, to minimize the energy related operation costs and/or decrease environmental impact, i.e. greenhouse gas emissions. When it comes to determining suitable microgrid topology, in some cases, a particular energy source might be discarded from consideration in advance, based on a heuristic, e.g. if solar harvesting potential is below a certain threshold the photovoltaic panels should not be considered for deployment. However, in principle, suitability of a particular source and its recommended size can only be determined once a comprehensive simulation and optimization of microgrid operation is performed. To illustrate in a simple example, a decision to deploy solar photovoltaic panels over wind turbines, or to have their combination, in an isolated microgrid, depends heavily on the correlation between generation profiles of each energy source with requested energy demand profile. Even such simple scenario of an isolated microgrid requires a long-term simulation and analysis, whereas in the case when all previously listed factors are considered it becomes a complex multi-criteria optimization problem.

Given the highlighted importance of energy demand profile on selection and sizing of appropriate microgrid architecture, a focus of presented research was partly focused on introducing an innovative approach for estimation of energy demand profile. Although being developed as part of the overall μ GM's Energy planning application, its underlying methodology and calculation algorithm will be elaborated independently in the following sections.

5.1. Overview of the state of the art approaches

The following section provides an overview of the state of the art energy planning tools and methodological approaches relevant for the microgrid design problem.

5.1.1. Energy planning tools and approaches

As previously elaborated, the μ GM's Energy planning application aims at providing end user with a tool for optimal microgrid design and retrofit. In particular, it aims at multi-criteria feasibility analysis of combination of different distributed energy sources, both

conventional and renewable, storages (and their corresponding sizes) and grid exchanges, to satisfy energy demand requirements under the dynamic market of energy prices. Currently, there is a number of integrated tools which focus on feasibility analysis of energy projects which might be considered for this purpose, to a lesser or greater extent. A recent review [112] covers 19 corresponding software solutions. Moreover, there is a vast number of scientific papers in the literature that feature advanced methodologies and approaches in solving this problem, at least to a certain extent. Before going into an overview of the most prominent tools and scientific approaches, it should be highlighted that the majority of them deals with the feasibility analysis of renewable energy projects, which is indeed a dominant aspect of the microgrid planning, but not the only one, as conventional distributed sources also play an important role, especially when it comes to the overall cost effectiveness.

Starting with an overview of the most prominent software tools, one of the most widely acknowledged tools is HOMER [113], initially developed at the U.S. National Renewable Energy Laboratory (NREL), which deals with evaluation of design options for large-scale off-grid and grid-connected power systems for remote, stand-alone, and distributed generation applications. It represents a renewable energy sources simulation framework, where different design options are evaluated, using a mixed integer optimization. Following is energyPRO software package [114], which represents planning tool for combined techno-economic modelling, design, analysis, and optimization of fossil and bio-fuelled cogeneration and tri-generation projects, as well as wind power and other types of complex energy-projects. Following is the RETScreen [115], which evaluates and compares renewable energy projects, their life cycle costs and greenhouse gas emission reductions with conventional technologies. A simulation and optimisation software iHOGA [116] evaluates performance of hybrid stand-alone electric renewable systems using evolutionary algorithms.

When it comes to existing scientific literature, the problem of planning hybrid renewable energy systems and microgrids has been extensively investigated in the past years. An exhaustive review of optimal planning of distributed generation systems is given in [117]. The most commonly adopted approach was to focus on analysis of isolated, the so-called island, use case scenarios. This was a natural first step, since the cost of renewable energy hindered its large-scale deployment and was limited to employment in rural areas, where

no conventional power grid was available. In such case, the planning problem was reduced to satisfying demand requirements and technical feasibility of proposed system, without taking into account flexibility of power grid nor the economic impacts associated with it. However, with the recent increase of various government-level subsidy programs for renewables, such as tax reductions for purchase of the renewable energy technology equipment and/or feed-in-tariffs that guarantee export price for produced renewable energy, their use even in electrified urban areas quickly became more attractive and even economically viable. However, maximizing the utilization of renewable energy sources in a grid-connected system and preserving the system reliability, while minimizing the energy costs, became the challenging task, one that the μ GM's Energy planning tool is aiming to solve as well. Although there is an abundance of scientific publications dealing with the problem of planning isolated hybrid renewable energy systems, the following is a brief overview of the scientific contributions dealing, in particular, with the grid-connected systems, as being more relevant for the development of the proposed solution. One of the initial approaches for the design of hybrid power generation systems considered algorithm based on a modified particle swarm optimization (PSO) algorithm [118]. The same technique was used for a real case study involving small sized renewable energy system [119]. Recently, a somewhat similar technique of artificial bee colony algorithm was used in [120] to determine optimal design of a grid connected hybrid photovoltaic-biomass energy system. In addition, the proposed approach was compared against the results received from the HOMER tool. Application of multi-criteria decision analysis (MCDA) for optimal sizing of hybrid photovoltaic and wind turbine systems was reported in [121]. The use of fuzzy logic for optimal design of a residential grid-connected microgrid with hybrid renewable generation and storage was reported in [122]. Employment of linear and mixed integer programming techniques for optimal design of grid-connected systems featuring plug-in electric vehicles (PEV) and integrated distributed resources was presented in [122]. The methodology presented in [124] utilized the same optimization techniques for planning of residential microgrid with demand side flexibility.

The enumeration of state of the art approaches in the domain is hereby concluded with the list of particular scientific contributions that are in direct relation with the proposed solution, given the adopted concept of energy hub as a general simulation and

optimization framework. Finally, to conclude, the following is an overview of scientific contributions directly connected to the purposed solution. As previously mentioned, the energy hub concept and its generic simulation and optimization framework were originally presented in [125]. The stated objective was to design a modelling concept that would be “sufficiently general to cover all types of energy flows, but concrete enough to make statements about actual systems”. Envisaged energy carriers comprise electricity, heating and gas, and possible application systems of the energy hub concept include power plants, industrial facilities, commercial complexes and urban areas [126], [127]. A key advantage of the energy hub model consists in the fact that it can be easily employed in conjunction with fast, reliable optimization algorithms, such as linear programming. Depending on the model formulation, more complex optimization approaches have been proposed in the literature. The work featured in [128], [129] develops a transient, nonlinear version of the energy hub that allows for variable efficiencies, and the generalized reduced gradient approach is employed to iteratively solve the nonlinear problem. A robust optimization approach is implemented in [130] for operating an energy hub with uncertain plant efficiencies. A mixed-integer linear programming modelling approach is employed therein and the solution approach featured in [131] is exploited to find solutions that are minimally affected by bounded uncertainties in the equipment parameters. Mixed integer formulations are also utilized in [132] for building energy systems, and in [133] and [134] where a combination of expert systems approaches and evolutionary programming techniques is applied to derive the optimal solution.

The methodology presented in the following is derived from the work presented in [135]. Linear and mixed integer formulations were adopted, since they are sufficiently accurate to model the system and afford a higher degree of computational efficiency. Extensions of the model, with particular regard to mixed-integer linear formulations, can be easily integrated in the model, if desired. The chosen approach is employed to model the Bilbao Exhibition Centre, for which it is desired to purchase and install additional energy assets to increase its overall efficiency.

5.1.2. Demand modelling

Currently, a number of building energy-demand simulation tools serves a variety of building energy management purposes. Depending on the adopted modelling methodology, the input data, required to develop energy models, include information on

the building physical characteristics, its occupants and appliances, historical energy consumption patterns, climatic conditions and macroeconomic indicators [136]. Dynamic models, involving building physics (envelope materials), building geometry and number of users are typically used to address building thermal energy demand, which comprise cooling, heating and domestic hot water demand. Inevitably, meteorological data are also found as one of the key inputs for such models and have a significant impact on their performance. Moreover, although complex computational fluid dynamics algorithms can further improve accuracy of such models, they increase model complexity and hence the required computational effort [137] [138]. Building energy efficiency related legislation in the EU, enacted during the recent years [139] [140], has resulted in an increased interest in utilization of energy demand simulators and development of underlying algorithms and approaches. In this regard, the EU member states are currently setting up comprehensive national calculation methodologies, in order to determine energy performance of both residential and non-residential buildings. This requirement for a methodology that may be sufficiently simple to be applied to a large number of buildings (potentially the entire EU building stock) to model their energy demand, and thus allow for their benchmarking and classification, coincided with the development of energy demand model for the purpose of Energy planning application. Therefore, considering this broader perspective, and opportunity to develop a model that can be exploited independently, an innovation energy demand modelling methodology was developed. The proposed methodology leverages user behaviour and existing appliances rather than building physics. In particular, its main objective is to enable estimation of electricity demand and associated costs at reasonable time resolution (e.g. hourly). The proposed methodology has been developed and integrated in a broader μ GM environment, i.e. the energy planning application. In addition, being less computationally demanding than typical building physics approaches, it can be applied with little overhead to expanded scopes such as districts, neighbourhoods, municipalities, as well as other utilities (e.g. water use and pricing), where the former approaches are clearly not applicable. Moreover, it should be noted that just as in the case of electricity and along a completely similar rationale, a model based consumption simulation could be developed also for non-electric energy use (oil, gas, etc.). To summarize, based on [142] and [143], energy demand estimation may considers several broad approaches as follows:

- The selection of an established, literature based, benchmark value; this value is mainly based on the building type and its geographic location. The benchmark value can be typically used to estimate the expected energy consumption of a building before it is built. It is useful and viable for buildings that are in a design phase, when it is not possible to audit an existing building or to use actual consumption data.
- The conduct of an energy audit; this approach requires the registration of all parameters affecting energy consumption (e.g. size, users, activity, number and type of energy consuming devices, etc.). This is achieved by means of an audit of the equipment being installed (KW) along an estimation of how long they will be running. The energy audit approach closely reflects the actual energy infrastructure in place, and results to a more accurate estimation when compared to the above, simple, benchmark values.
- The use of actual building consumption data; Here, real consumption data need to be used. Typically, these may be available in a time interval of one, two, three, months, etc. Obviously, for the method to be used, data, for at least a year, must be available. In addition, besides building level energy bills, other sources of actual energy consumption data, such as smart energy meters, may provide actual consumption data at device level and at various sampling rates, ranging from seconds to days. The estimates of appliance usage times, required in the previous energy audit method, may now be eliminated by “sub-metering”. This implies usage of energy metering devices on specific, usually energy consuming, appliances within the building, with the aim to determine both their component of the energy consumption as well as their usage profile in time [144].

Having briefly introduced the state of the art in the respective domains, the following sections elaborate in detail the methodology proposed by this thesis, as well as the developed software tool.

5.2. Proposed methodology

5.2.1. Multi-criteria microgrid design

The proposed microgrid planning methodology, used to devise optimal microgrid topology and sizing of its individual components, aims at fundamentally enhancing

existing planning tools and algorithms by combining previous approaches and adding new design aspects. In particular, it introduces and brings together the following aspects:

- First, the overall microgrid planning process considers simultaneously both electric and thermal energy demand. Current approaches typically consider either electric or thermal domain and leverage their methodology on balancing this demand independently with considered energy sources and storages. However, increased utilization of devices like heat pumps, which satisfy thermal demand by contributing to electricity demand, requires an integrated assessment approach.
- Second, the common approach of considering an isolated microgrid is extended towards grid-tied configurations and a more dynamic context, where varying energy prices are applied and unlimited energy exchange with power grid is enabled.
- Third, the ever increasing application of Demand Response (DR) programs in day-to-day operation is evaluated and corresponding implications on the sizing of individual microgrid components (e.g. demand flexibility may reduce the required storages size) and life-cycle assessment (LCA) is considered through an integrated optimization process (supporting both linear and non-linear optimization techniques).
- Fourth, multi-criteria decision algorithms (MCDA) are employed to rank feasible microgrid topologies and simultaneously evaluate a wide range of technical, economic, environmental, and societal design criteria.
- Finally, for the purpose of increasing robustness of the proposed methodology, a sensitivity analysis of all critical parameters is enabled through employment of stochastic models for renewable energy generation and end user consumption.

5.2.1.1. Design criteria and constraints

The proposed methodology considers different design criteria, which can be summarized into four general categories. Following is their enumeration whereas detailed elaboration of each category and its items will follow later in the text:

- Technical criteria: Loss of Power Supply Probability (LPSP), Wasted energy

- Financial criteria: Capital Expenditure (CAPEX), Operational Expenditure (OPEX), Net Present Value (NPV), Internal Rate of Return (IRR), Payback Period (PP)
- Environmental criteria: Greenhouse gas emissions (CO₂, NO_x, SO_x)
- Social/Economic/Political criteria: Fuel Reserve Years, Job creation, Inter-country energy dependence etc.

When it comes to design constraints, various context- and user-defined constraints are considered. The former represents renewable energy harvesting potential, applicable energy pricing policy, space availability and orientation for deployment of energy assets etc. while the latter entails constraints in terms of energy demand and associated end user habits, demand flexibility, allowable equipment budget etc. The following list aggregates the most influential design constraints into several categories:

- Renewable energy sources (RES) harvesting potential
- Building characteristics and space availability constraints
- Energy demand requirements
- Dynamic energy pricing
- Financing conditions
- RET equipment characteristics
- RET installation parameters

Each category entails a list of constraints, as depicted in Figure 19, which are simultaneously assessed by the proposed methodology in order to deliver optimal microgrid topology and sizing.

The previously elaborated design constraints, in fact, define a set of boundaries for the search space in which the optimal design solution is found. However, within this constrained space there is still a significant number of feasible design alternatives found. In the following elaboration, each design alternative will be referred to as microgrid configuration, which entails both topology and sizing of the energy assets within.

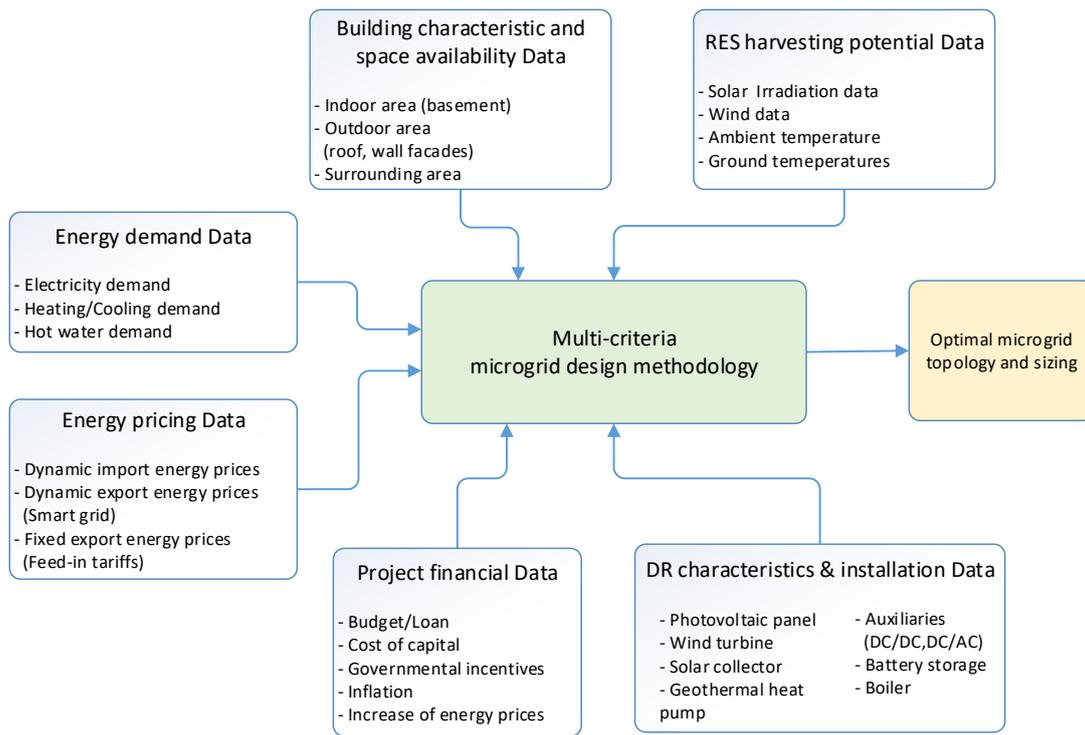

Figure 19: Overview of RET configuration design parameters

Given the variability of generation from renewable sources, energy demand requirements and dynamically determined energy costs, each feasible configuration is modelled and its long-term operation is simulated/optimised. When deciding on the simulation time horizon and size of the time step resolution, several factors were taken into account. First, a long-term performance of a microgrid is heavily influenced by the renewable energy harvesting potential, which implies utilization of historical meteorological conditions for a given location. Moreover, since the performance should be evaluated for the entire microgrid lifetime, which is typically around 20 years, it was decided to use the so-called Typical Meteorological Year (TMY) data, which provide hourly data for averaged meteorological conditions over a relatively long period and, thus, objectively characterize the specific geographical location. Second, given the objective to establish long-term assessment of microgrid operation, the linear (or mixed integer) models of energy assets running on hourly resolution are sufficiently complex. Consequently, hourly resolution was chosen as the time step, whereas the time horizon is one year, although performance assessment takes the results of this one-year simulation/optimisation as many times needed (e.g. 20 years), while taking into account events such as replacement of an asset (e.g. batteries typically last for 5 years).

5.2.1.2. *Microgrid configuration*

Electrical domain

The electrical domain of a microgrid configuration considers all devices that produce, store and use electricity for the end use, as defined in the previous chapters. The backbone of this domain is represented with two buses, direct current (DC) and alternate current (AC) bus, to which all devices are connected. In order to allow for unlimited energy flows from one bus to another, appropriate energy converters were introduced, i.e. a DC/AC inverter and a rectifier, accordingly.

As far as energy production is concerned, both photovoltaic panels and wind turbines are considered. Having in mind the application of the overall sizing methodology, i.e. to size a small-sized (residential or building level) microgrid system, utilization of DC generation units was primarily considered. However, this does not affect the applicability and generality of the approach. These generation units are then connected to the rest of the system via DC bus. Although, in reality, each of these units is followed by a DC/DC converter before connecting to the DC bus, in order to stabilize the current and voltage levels, these converters are intentionally omitted from the figure for the sake of clarity and simplicity. Once generated energy is delivered to the DC bus, it can be stored in a battery storage system, via bi-directional DC/DC converter, or transferred towards AC bus, via DC/AC inverter, where it can be further used either to satisfy the local AC loads or to export energy towards energy market via utility grid.

The storage system represents one of the key elements in a microgrid configuration, as it is able to store excess energy from generation units or to provide energy in case the local loads are not fully satisfied. In that way, storage system acts as a unique energy buffer and allows for optimization of both microgrid configuration topology, as well as energy dispatch strategies. In the configuration depicted in Figure 20, storage system takes the central position (at least logically) and has all the necessary interfaces that enable previously described functionalities, as following. First, the storage system is connected to a DC/AC inverter, which enables discharge of storage towards AC bus and

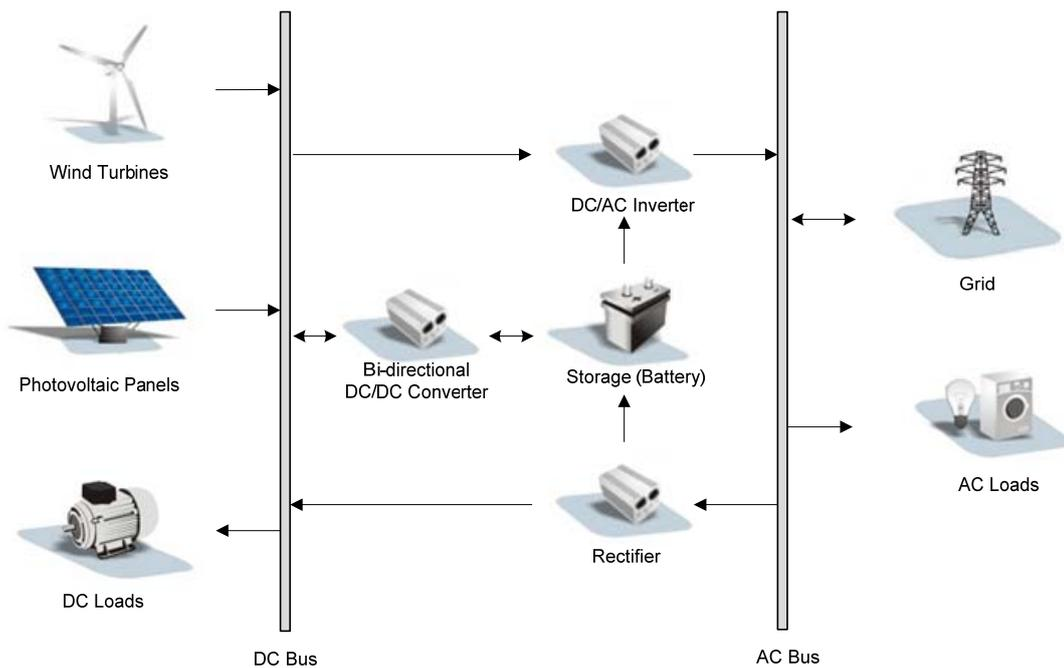

Figure 20: Electrical domain

consequently assures satisfaction of local AC loads or export to the utility grid. Second, the storage system is connected to a rectifier, between DC and AC bus, and enables charging of the storage system with energy coming from the utility grid. This operation has particular sense in case of dynamic energy purchase prices. In that case, storage system can store energy when the tariff is low and use it afterwards, when the tariff gets high. The same operation is applied in the utilization of hybrid electric vehicles (HEVs) as storage systems, which is a common procedure in the Smart Grid concept. Finally, the storage system is connected to a bi-directional DC/DC converter, which enables connection towards DC bus, and therefore has a dual role. First, it allows for charging of the storage system with energy coming from the local generation units and, second, it allows for discharge of the storage system in order to satisfy the local DC loads.

Considering that the local loads were already analysed with previous units, it can be simply summarized with the following. The local loads are divided into AC loads and DC loads and consequently connected to appropriate buses. Auxiliary units in the configuration enable transitions between the two domains, DC and AC, and/or simply secure that voltage/current levels are within allowed limits. Their more specific use is previously explained. Finally, the utility grid is concerned within the general microgrid configuration. Although, this seems as a natural component of any electrical system, the

utility grid was not taken into account in the previous methodologies, aiming to determine topology and size of a small-scale microgrid system. Moreover, the vast majority of investigated methodologies from the literature took into account only “island” microgrid configuration, which represents an isolated microgrid, where there is no possibility for the utility grid to intervene in cases of lack or excess of energy coming from the generation units, when trying to meet the local loads.

Thermal domain

The thermal domain of a microgrid configuration considers all devices that produce, store and use heat for end use, as depicted in Figure 21. Considering that the aim is to size an optimal system for a residential (and/or building) user, appropriate heating systems, that leverage themselves on renewable energy, were considered. Starting with energy generation, or more specifically, heat generation, the two typical systems were considered - the solar collector system and geothermal heat pump system. Unlike the production and storage units form the electrical domain, which can be analysed independently, the thermal systems usually consider these units as an integrated system.

The solar collector system consists of the collector itself, which may be strictly referred to as generation unit, and a thermal storage system, which is a boiler. However, this boiler is not just simple hot water storage, but usually has an electric heater attached to it. This heater enables that user’s hot water requirements, in both volume and temperature, are met, regardless of the captured solar energy coming from the collector. Apart from electric heater, the solar collector system requires several auxiliary devices, such as water pumps, to enable the distribution of hot water. Since both heater and auxiliary devices contribute to the overall electrical loads, this represents one of the key points of integration between electrical and thermal domain.

The other heat generation unit is geothermal heat pump system, which consists of the ground loops, which are used to extract the heat from the ground and thus generate the thermal energy, and a geothermal heat pump itself. Similarly, as in case of solar collector, a geothermal heat pump has a dual role of storage system, as well as booster of heat generation, leveraging on the utilization of electricity. Namely, the heat pump uses the electricity to power the compressor and perform the heat exchange between the ground

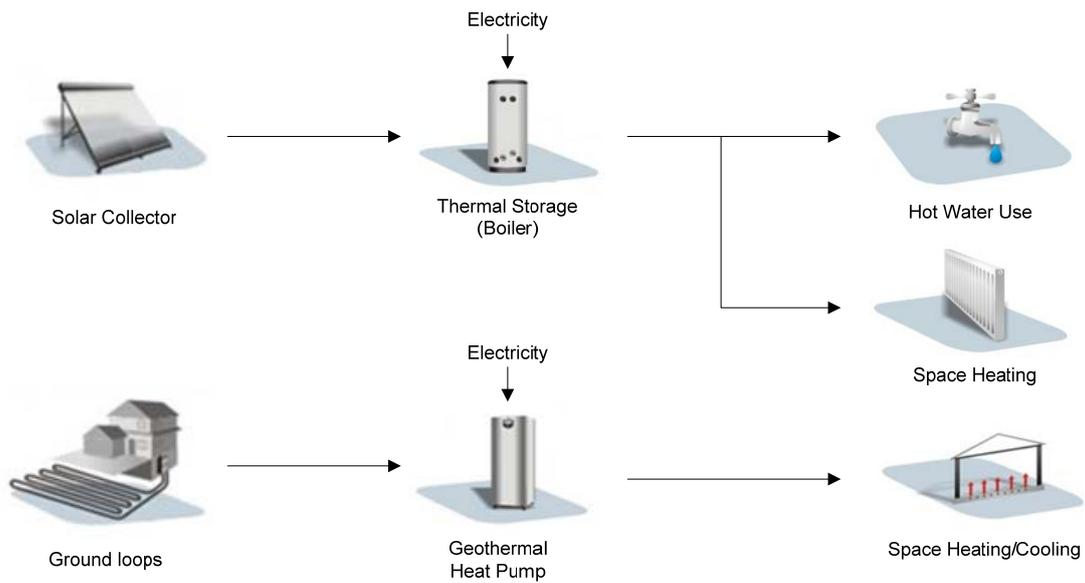

Figure 21: Thermal domain

loops and loops responsible for delivery of hot water for end use. Moreover, there are several water pumps, powering the hot water distribution system, that also contribute to the overall electricity consumption and thus create another integration point between the electrical and thermal domain. When it comes to the thermal energy end use, the typical residential usage was considered. This implies hot water use for sanitary purposes, heating and cooling. Owing to the particular construction of both generation units as well as their thermal energy harvesting potential and conventional application in practice, the following relations were established. The hot water coming from the solar thermal system can be used in two typical scenarios, either for hot water end use only (sanitary purposes) or for an integrated system, allowing for both heating of sanitary water as well as space heating. In case of geothermal heat pump system, water coming from the ground loops can be used for either space heating or space cooling, depending on the season. The reason for this is that the temperature of the ground loops water is almost constant throughout the year, depending on the particular geographical location, which often results in ability to cool in summer periods and heat in winter periods.

5.2.1.3. *Microgrid design optimization*

The proposed methodology is depicted in Figure 22 and suggests all the necessary algorithmic steps that lead towards the most appropriate microgrid configuration.

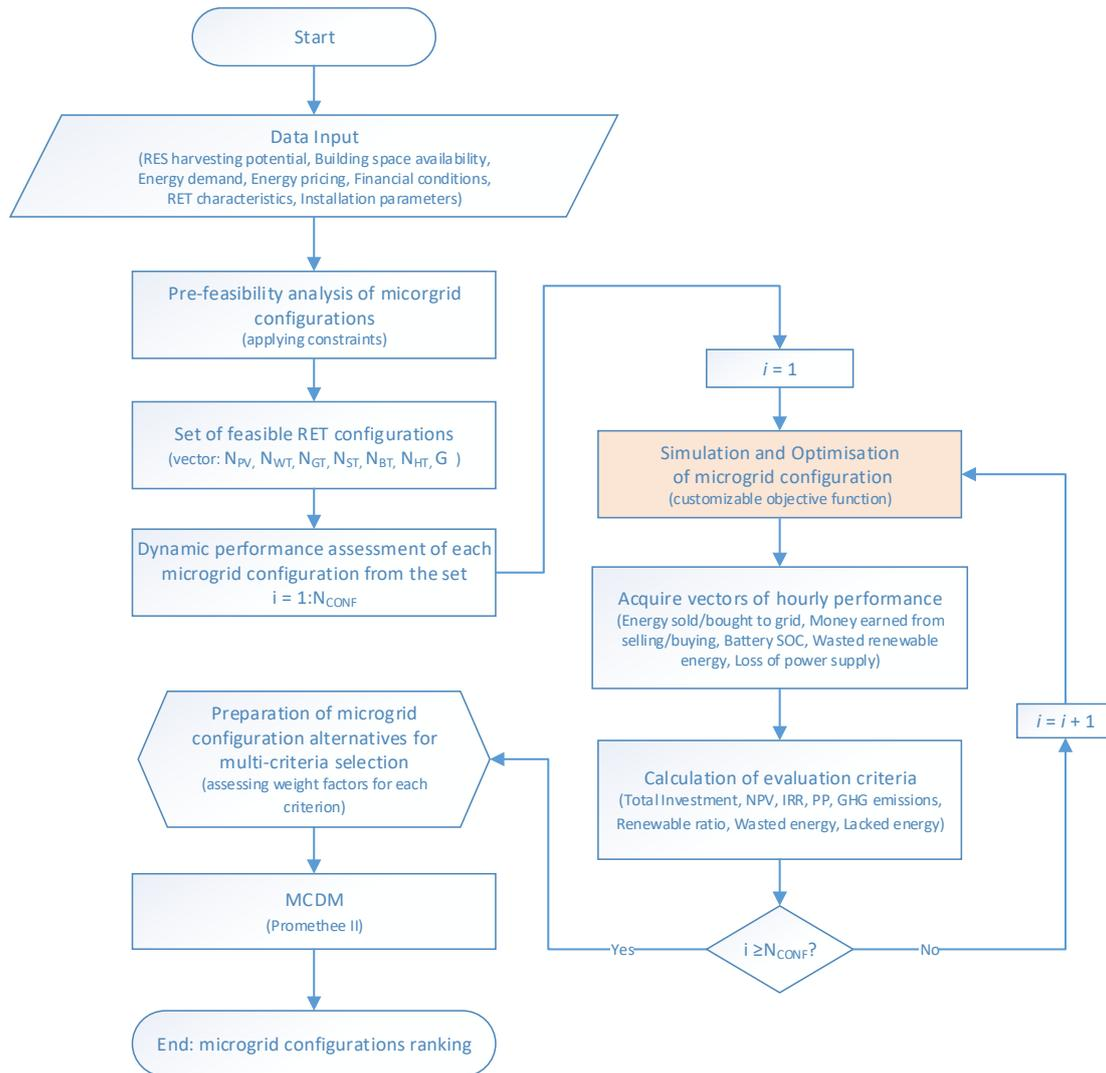

Figure 22: Microgrid design optimisation workflow

Data input

The algorithm starts with gathering of all previously elaborated inputs, which can be summarized into the following: renewable energy harvesting potential of location, building space availability, requested energy demand, applicable energy pricing, financial conditions, microgrid equipment characteristics and finally equipment installation parameters.

Pre-feasibility analysis of microgrid configurations

The algorithm continues with the pre-feasibility analysis of potential microgrid configurations, which aims at acquiring a limited set of configurations that satisfy the following user and site constraints.

Once the constraints are applied, they form an intersection of solutions (configuration super-set) which typically considers a wide range of possibilities and narrows the search only to a certain level. However, since all configurations from the super-set are then considered for further revision and investigation in the following steps, thus subjected to hourly based simulations, it is important to reduce this set as much as possible and avoid involving enormous computational efforts, which is one of the most important objectives of the proposed methodology. Therefore, in order to avoid any brute force approach that would go through all possible combinations for a microgrid configuration several important heuristics were introduced that reduce the number of possible alternatives.

First, regarding the electricity domain of configuration, it is important to distinguish the two typical use case scenarios for the resulting configuration, i.e. whether it will be operated in an island (off the grid) or grid-connected mode, which influences the approach dramatically for several reasons. In case of island mode, which is the common scenario tackled by the similar methodologies, the number of generation units is estimated following the requirement that the total generation from renewable energy sources should be able to satisfy the energy demand, since there is no other option. However, considering very high discrepancies between the typical hourly generation and consumption profiles this condition may result in an extremely oversized system, which would never be economically justified comparing to any other alternative (e.g. fossil fuels). Therefore, this requirement ought to be relaxed in a way that only the yearly totals must match, regardless of the mismatch that would, naturally, occur between the profiles. However, with the utilization of appropriate energy storages this mismatch could be successfully tackled and uncompromised energy supply can be provided. Contrary to island mode use case scenario, a grid-connected scenario fails to provide such distinct requirement when it comes to the number of generation units, since the power grid, acting as unlimited source and storage of energy, can compensate any mismatch between the generation and consumption profiles. Therefore, in case of either over- or under-sized system, any excess or lack of energy can be compensated by unlimited export or import of energy, respectively. Hence, there is no reasonable heuristic that could be employed to size the generation system unless an evaluation of configuration economic benefit is undertaken, considering dynamic import and export energy prices. Moreover, having in mind the stochastic nature of renewable energy sources, unpredictable energy market prices and

user's energy demand, a range of different system size alternatives should be inspected and carefully evaluated in order to reach the most suitable one. On the other hand, initially introduced constraints, related to harvesting potential, spatial, and financial boundaries, represent a common limitation as far as number of generation units is concerned, regardless of the use case scenario. Regarding the electricity storage capacity (battery storage), their utilization, and thus dimensioning, is also strongly affected by the use case scenario. In case of grid-connected systems, their only role is to serve as energy buffers and allow for operation optimization, taking the advantage of fluctuations of energy prices. Therefore, several options for the battery capacity should be included in the search. However, in the case of island mode operation, the battery storage should provide the means for uninterrupted energy supply and therefore strongly affects the reliability of the system. Considering this, the storage system capacity is determined by the nature of the energy generation and consumption profiles, more precisely, their mismatch over analysed time period which will be assessed in detail in the following subsection.

When it comes to dimensioning of thermal part of the system, the situation is opposite, comparing to the one of electricity, again for several reasons. First, in case of existing buildings, there is usually some kind of thermal system already installed, such as district heating system, boilers using fossil fuels (gas, fuel oil, coal, wood chips), electric boilers etc. These systems usually require high initial investment costs and therefore installation of any redundant thermal system, based on renewables, for example, would have to compensate double investment costs in order to reach the return on investment. Therefore, this methodology suggests that only unmet thermal loads, if they exist, should be considered for dimensioning of additional thermal system. Naturally, in case of new buildings, without any pre-installed thermal system, all thermal loads should be accounted for. As defined previously, the thermal loads consist of space heating/cooling demand and hot water demand and, depending on the existence of each type of demand, a specific renewable energy based thermal system is suggested.

Regarding the problem of over- or under-sizing of the thermal system, there is a critical difference between thermal and electrical domain. Contrary to the electrical domain, where there is usually a power grid available, serving as unlimited source and storage of energy, in case of thermal domain there is no, at least for now, existing infrastructure that would enable unlimited export of thermal energy. Consequently, there is no use of over-

sizing the thermal system and thus producing more thermal energy than required (especially as it requires consumption of electricity to a certain extent), as it cannot be sold and/or exchanged. On the other hand, under-sizing the system may cause increased consumption of electricity if there is no other alternative source of thermal energy, as previously mentioned. Considering the thermal energy storage, which is typically a boiler, its size is commonly predetermined with the estimation of the appropriate heating system capacity.

Having in mind the previously stated, it is obvious that the dimensioning of the thermal system is independent from the rest of the configuration. Therefore, sizing of the thermal components should be conducted, first as they will make significant reduction of the overall budget (geothermal system require high investment costs) and available space (solar collectors require large areas), which will influence dramatically the search space for the appropriate combination of electrical sources.

Nevertheless, a number of potential combinations for microgrid configuration can still be very high, especially if it is a grid-connected case and the number of energy sourcing units cannot be reasonably predicted without conducting hourly simulations and performing an economic evaluation of hourly energy exchanges with the power grid, throughout the simulated period. Therefore, additional reduction of configurations super-set is performed, utilizing the principles of linear programming (LP) which will be further elaborated in the following subsections.

Dynamic performance assessment

Once the reduced super-set is derived, it consists of a range of feasible solutions under the given constraints and the requirements set by the user. In order to be able to compare them across several design criteria, it is necessary to run the hourly simulations for each alternative. This leads to another key feature of the proposed methodology, which is to allow for multi-criteria evaluation of each alternative. Unlike the vast majority of similar methodologies, which commonly leverage their optimization on a single criterion (financial benefit, reliability etc.), the proposed methodology takes into account a range of criteria, covering technical, environmental, financial and socio-political objectives.

The algorithm then enters a loop, the purpose of which is to run the hourly simulations for each configuration alternative. As discussed before, a customizable energy dispatch strategy is applied and a list of monitoring variables, used for evaluation of design criteria, is derived. It should be emphasized, though, that each of these variables is, in fact, a vector containing $24 \times 365 = 8760$ values. Although a complete list of variables is too extensive, a subset of the most important ones is given in the following:

- Energy sold – stores the information about renewable energy export towards the grid.
- Money earned – stores the information about money earned from selling which is product of exported amount of energy and dynamic energy selling tariff.
- Energy bought – stores the information about energy import from the grid.
- Money spent – stores the information about money spent for buying, which is product of imported amount of energy and dynamic energy purchase tariff.
- Battery SOC – stores the information regarding the fluctuations of battery SOC.
- Wasted renewable energy – stores the information about the intervals when wasting of renewable energy occurred.
- Loss of power supply – stores the information about the intervals when loss of power supply occurred.

Using these variables that reflect dynamic performance of an alternative and combining them with general (fixed) parameters of the configuration itself (e.g. number of units, investments/maintenance costs etc.), a list of evaluation criteria, combining the aforementioned objectives, is defined as following:

- Total investment costs –overall investment costs, encompassing equipment capital cost as well as necessary equipment installation costs.
- Net Present Value (NPV) –NPV of the project associated with the overall investment in microgrid configuration.
- Internal Return of Return (IRR) –IRR of the project associated with the overall investment in microgrid configuration.
- Return on Investment (ROI) –ROI of the project associated with the overall investment in microgrid configuration.
- Greenhouse Gas (GHG) emissions –overall emission of GHG during average year of operation.
- Renewable energy ratio – ratio of consumed renewable energy over total consumed energy.
- Wasted energy –ratio between the wasted and total harvested renewable energy (island mode).

- Loss of Power Supply Probability (LPSP) –ratio between the total hours when loss of power supply occurred over one-year period and the actual amount of energy that was lacking.

The list of evaluation criteria is then calculated for each configuration from the set in an iterative procedure involving hourly simulations of the system in each iteration.

Total investment costs

The total investment is used as one of the key design criteria, as it allows the user to make the preference for the most affordable RET configuration alternative among the feasible solutions. The total initial investment costs consider both equipment capital costs and installation costs, reduced for the amount of governmental subsidies (in percentage), covering a share of these costs. The following mathematical expressions are used for the calculation:

Initial investment costs = (Equipment costs + Installation costs) · (1 – governmental subsidies)

$$C_{investment} = [N_{pv} \cdot (C_{pv} + I_{pv}) + N_{wt} \cdot (C_{wt} + I_{wt}) + N_{gt} \cdot (C_{gt} + I_{gt}) + N_{st} \cdot (C_{st} + I_{st}) + N_{batt} \cdot (C_{batt} + I_{batt}) + N_{tank} \cdot (C_{tank} + I_{tank}) + N_{inv} \cdot (C_{inv} + I_{inv}) + N_{rec} \cdot (C_{rec} + I_{rec})] \cdot (1 - gs) \quad (60)$$

where $C_{investment}$ – represents overall investment, N_x – number of units of device/system X , C_x – capital cost in Euros per unit of device/system X , I_x – installation cost in Euros per unit of device/system X and gs – governmental subsidies, depicting government contribution in the overall investment in percentages.

Net Present Value

The economic appraisal of the proposed investment is depicted with a set of common project evaluation parameters, starting with the net present value (NPV) defined for the purposes of this methodology as following:

$$NPV = -C_{investment} + \sum_{k=1}^{N_t} \frac{C_{cf}(k)}{(1 + i_{dsc})^k} \quad (61)$$

where $C_{investment}$ have been defined previously, $C_{cf}(k)$ – represents annual net cash flow for year k , i_{dsc} - is the discount rate and N_t – is number of years of the lifetime of the project. When determining the applicable discount rate, various parameters, such as

capital cost, risk, inflation rate etc., can be taken into consideration. For the purposes of this methodology, a common solution was applied:

$$(1 + i_{dsc})^k = (1 + i_{cc})^k (1 + i_{inf})^k = (1 + i_{cc} + i_{inf} + \underbrace{i_{cc} \cdot i_{inf}}_{\rightarrow 0})^k \quad (62)$$

where i_{cc} - is the cost of capital rate, i_{inf} - is the inflation rate. The annual net cash flow represents the overall expected net cash flows, originated from the operation of the proposed investment such as expected income, outcome, savings, maintenance costs and replacement costs.

Internal Return of Return (IRR)

Another economic evaluation parameter, which serves as complementary criterion to NPV, is the internal rate of return (IRR), which is defined as a rate of return at which NPV equals zero. Therefore, the following equation, where IRR is expressed implicitly, is used:

$$-C_{investment} + \sum_{k=1}^{N_t} \frac{C_{cf}(k)}{(1 + IRR)^k} = 0 \quad (63)$$

Similarly as NPV, the IRR can be used for determining whether the investment is justified, especially in cases when NPV does not provide for a clear suggestion. This is achieved by comparing calculated IRR against Minimum Attractive Rate of Return (MARR), which is the minimum discount rate accepted by the market corresponding to the risks of an investment.

Return on Investment

Often referred to as one of the most tangible economic evaluation parameters, the return on investment (ROI) clearly depicts the time necessary for the investment to pay-off. Although it seems as a simple benchmarking tool, it is necessary to establish the distinction between the return on invested money, which involves the cumulative net cash flows, and the return on invested value, which includes consideration of discounted cash flows. The second approach takes into account the time value of money and therefore is assumed to be more accurate than the first one. Therefore, the return on investment can be derived from the cumulative discounted cash flow, which is calculated in an iterative

procedure for each year and then compared with the investment. Once the cumulative discounted cash flow exceeds the overall investment it is considered that the investment is returned. Similarly as for the NPV, the following equation implicitly defines the ROI:

$$-C_{investment} + \sum_{k=1}^{ROI} \frac{C_{cf}(k)}{(1+i_{dsc})^k} = 0 \quad (64)$$

Greenhouse Gas emissions

As commonly acknowledged, the conventional power grids offer electricity which is associated with emission of gases that harm the environment. They are known as greenhouse gases (GHG) and encompass various harmful gases. The overall emissions are estimated by applying an “emission factor” to the quantity of energy consumed by the analysed system. These emission factors are country-specific and depend on the structure of the country energy system, i.e. the share of hydro, thermal, nuclear plants etc. Moreover, it basically depicts whether the country has low or high carbon electricity generation and thus create lower or higher GHG footprint. Emission factors for grid electricity are published for most of the countries and they are easily accessible at the International Energy Agency¹⁵. Typically, the emission factors encompass CO₂, CH₄, and N₂O gases and therefore the total yearly GHG emissions are estimated using the following expression:

$$GHG = \sum_{i=1}^{8760} E_{import}(i) \cdot (EF_{CO_2} + EF_{CH_4} + EF_{N_2O}) \quad (65)$$

where $E_{import}(i)$ is energy imported from the power grid [kWh], EF_{CO_2} is emission factor [kgCO₂/kWh], EF_{CH_4} is emission factor [kgCH₄/kWh], EF_{N_2O} is emission factor [kgN₂O/kWh].

As elaborated, the above expression depicts the absolute figure of GHG emissions for the given system after the implementation of the proposed RET configuration. Therefore, the information about the actual GHG emission savings that were yielded by the system that

¹⁵ IEA Statistics by country/region for electricity/heat, <http://www.iea.org/statistics/>

the proposed methodology suggests are not revealed. In order to do so, baseline energy consumption should be hired and the following expression estimates the savings:

$$GHG_{savings} = \sum_{i=1}^{8760} (E_{baseline\ import}(i) - E_{import}(i)) \cdot (EF_{CO_2} + EF_{CH_4} + EF_{N_2O}) \quad (66)$$

where $E_{baseline\ import}(i)$ - energy imported from the power grid in a baseline scenario when the RES system is not applied [kWh].

Non-renewable energy ratio

The following evaluation criterion describes how much the proposed system is “green” or not, by taking into account the non-renewable energy share in the overall consumption. Basically, it is calculated as the ratio between non-renewable energy consumed, over total energy consumed throughout the year, as defined in the following:

$$Non - renewableratio = \frac{\sum_{i=1}^{8760} E_{import}(i)}{\sum_{i=1}^{8760} (E_{electricity}(i) + E_{heating/cooling}(i) + E_{hot\ water}(i))} \quad (67)$$

Wasted energy

Considering the island operation, occurred either from the lack of power grid infrastructure or temporary grid failure, it is of critical importance to evaluate any wasted renewable energy, which is the result of the mismatch between energy generation and consumption profile and lack of storage capacity. This information can be then used for analysis and consideration of existing or new storage systems, which would be able to compensate the profiles mismatch. Even more, appropriate sizing of the storage system may result in reducing the size of generation system and thus cutting the investment costs.

$$Wasted\ energy = \sum_{i=1}^{8760} E_{wasted}(i) \quad (68)$$

where $E_{wasted}(i)$ - represents the unused renewable energy at hour i .

Unmet supply and Loss of Power Supply Probability

Contrary to the previous, another, even more important, criterion is used for the evaluation of system reliability regarding power supply. Considering that uninterrupted

power supply became a standard and even a critical requirement in some applications, it is necessary to define and include a measure of reliability in the overall evaluation of the proposed system configuration. In relation to this, the two parameters were defined, the total unmet supply and a well known loss of power supply probability (LPSP), which clearly represent the system availability throughout the typical operation.

$$Unmet\ supply = \frac{\sum_{i=1}^{8760} E_{lack}(i)}{\sum_{i=1}^{8760} (E_{electricity}(i) + E_{heating/cooling}(i) + E_{hot\ water}(i))} \quad (69)$$

$$LPSP = \frac{\sum_{i=1}^{8760} hour_{lack}(i)}{8760} \quad (70)$$

where $E_{lack}(i)$ - represents the lack of power supply at hour i and $hour_{lack}(i)$ - is a logical variable representing whether an interrupt of power supply occurred during hour i . Apart from the evaluation of each system configuration, which is then used for mutual ranking of different alternatives, these parameters also offer a valuable backward loop for the design of generation system and may result in changing the considered configuration super-set in order to obtain more reliable system.

Multi criteria ranking of configurations

Finally, when the iterative simulation procedure is concluded, and the list of evaluation criteria is derived for each configuration, it is necessary to establish appropriate ranking among the configurations, considering multi-criteria (multi-dimensional) evaluation space. In order to do so, an existing multi-criteria decision making (MCDM) algorithm was employed. The functioning principle of MCDM is depicted in Figure 23.

At initial stage, the MCDM is fed by a list of alternatives (A) which ought to be simultaneously ranked across multiple criteria (C). Each alternative A, represented by individual microgrid configuration, is first individually evaluated across the whole range of criteria C, referred to as evaluation criteria in the dynamic performance assessment elaboration. Following is the assignment of the weighting factors (W) to each criterion C. These weight factors allow for non-uniform distribution of the level of importance assigned to each criterion, allowing end user to practically steer the selection process,

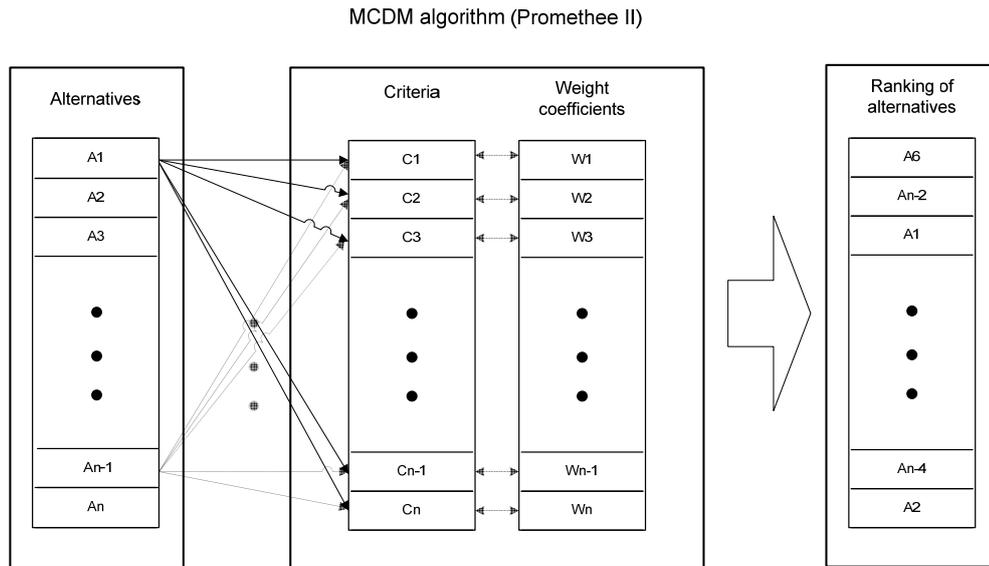

Figure 23: MCDM functioning principle workflow

according to desired needs and preferences. For the purpose of development of MCDM functionality, the acknowledged Promethee II algorithm [145] was utilized.

5.2.2. Energy demand modelling approach

The energy demand modelling approach assumes an hourly resolution, which has proven adequate. This applies to both the electric energy use (kWh) and the applicable, within every hour, electricity price (c€/kWh). The applicable electricity tariff will often require considering electricity price as dependent on the energy use itself. The methodology includes an energy audit component, while the simulation results are calibrated by means of actual consumption data, to improve accuracy. Last, the new concept of “use profiles” is introduced, to allow for a radically increased accuracy of the simulation. The proposed energy demand modelling methodology will be presented as a conceptual framework as well as a calculation procedure in the following.

Energy use profiles

Energy use profile is a concept used to identify distinct building energy use patterns. User behaviour is one of the most important input parameters, influencing the results of building performance simulations as introduced in [145], [147] and [148]. The energy use profiles, in the EUM methodology, is essentially the concept introduced to model user

behaviour. Energy systems and devices installed in a building can then be easily allocated to one or more of these energy use profiles. For instance, outdoor lighting may be switched on during the night hours. Thus, the “night hours”, need be defined as a specific use profile. Personal computers, in a school, may be switched on only during daytime on working days. The “working hours” would then be the respective, required, use profile for these electric devices. The user can define as many profiles as he wishes. A status bit (ON/OFF) serves to define whether the use profile refers to devices switched on (ON status) or switched off (OFF status) during the selected hours of the profile. An energy use profile is, technically, a matrix of 8760 (hours of a year) binary values. For the “ON” profiles, the selected hours will be set to one, while all the rest will be set to zero. For the “OFF” profiles the selected hours to be set to zero, while the rest of them will be one. Every electric device may now be allocated to one or more use profiles. Device use profiles are essentially a combination of simple energy use profiles. For example, a school is normally closed during summer months. Thus, its electric devices will be influenced by both the “working hours” use profile and the “summer” use profile. The methodology allows constructing device profiles from any number of use profiles, previously defined.

Energy audit

A breakdown of the electric equipment installed in the building needs to be prepared by means of a classic audit exercise. This will be used by the EUM methodology to calculate hourly energy use values. Electrical energy use refers to lighting, appliances (cooker, washing machines, etc.) and equipment (PC, TVs, printers, etc.) as well as heating/cooling equipment. In the case of a renewable energy system installed, energy use models may also greatly assist renewable sizing and installation decisions, by providing a good estimation of the hourly energy demand. Ideally, besides the use models, hourly production models would be also required to best optimize the renewable set-up and support decisions on storing, selling and using renewable energy.

Electric energy pricing

The pricing application has been designed to support the two main current tariff practices, either separately or in combination. These are time period pricing and load zone pricing. In period pricing, the price of electricity may differ from hour to hour, day to day, or month to month. A number of pricing periods are usually applied and the price is

discriminated among them. The Italian case study, described in Section 6.2 involves this type of energy pricing. Load zone pricing differentiates energy prices, based on the consumption level within particular billing periods. Two types of load zone pricing are possible:

- The price is generated from the total consumption within the billing period. Thus, it may only be known and applied after the end of the billing period.
- The price varies according to specified load zones within the billing period. The Greek case study, described in Section 6.1, involves this type of energy pricing.

It should be mentioned that in cases where period and zone based pricing are both part of the tariff scheme, priorities must be assigned for cases of potential conflict. For example, if period pricing requires a high tariff for summer noon hours, and the consumption level, within the billing period, is low, then the priority must dictate whether the price is selected based on the period tariff or on the load zone one. From investigated cases, the period seems to be taking priority over the load; however, in the simulator the option to select and assign the priority is provided. It is important to stress that the energy use models will affect the pricing simulation in the case of load zone pricing, since the tariff will change every time consumption crosses over the higher zone. Thus, in the simulation it has been necessary to use the energy use model estimations as a basis for estimating the applicable hourly consumption zone level and therefore retrieve the correct price.

5.2.2.1. Calculations

When an energy audit is carried out, all the energy devices/systems in place, as well as their nominal figures [power: P_n , W], should be identified. The wattage labelled is the power drawn by the appliance. Since many appliances have a range of settings (for example, the volume on a radio), the actual amount of power consumed depends on the setting used, at any particular time. Devices such as speakers rarely work on their full power. Therefore, the auditor should make a relatively accurate approximation of the actual power as a percentage of the respective nominal one. A special, device level coefficient [act nom, actual to nominal coefficient], is introduced to model this difference between the nominal and actual figures.

The percentage of the running time [time percentage, use time percentage] of all devices is now required. Even if this could be possible in a yearly level, it would be difficult to

provide an hourly distribution of the figure throughout the year to essentially match the resolution of the simulator. In other words, even if one succeeded in an estimation of the hours per year a particular energy system runs, the question remains how these hours could be possibly distributed at the hourly level. The concept of the use/device profiles is pivotal in reaching a realistic estimation of this distribution. For example, if the selected profile for a lamp is night, and night is defined by the user, from 10 pm to 6 am every day, then a time % = 100% means that lamp is switched on from 10 pm to 6 am every day. On the contrary, 50% use means that device is used for about 4 h during night hours.

The simulated energy use within the [i] hour by the [j] electric system is then calculated as follows:

$$E_j[hi] = Q \times P_n \times act_nom \times time_perc \times UP \times 1 h \quad (71)$$

Where

- Q - is the number of devices of the electric system
- $E_j[hi]$ - is the energy consumed within the referenced hour by the specific device
- P_n - is the nominal power of the specific device
- act_nom - is the ratio of actual to nominal power
- $time_perc$ - is the time percentage of use, when the system is used;
- UP - Is 1, if the device profile has the referenced hour set at 1 or $UP = 0$ if the device profile has the referenced hour set at 0.

Overall, the simulated energy consumed by all the electric systems is calculated as follows:

$$E[hi] = \sum_{j=1}^n E_j[hi] \quad (72)$$

where n is the number of electric systems identified. The total annual building energy E used by all the electric systems identified, is calculated as follows:

$$E = \sum_{i=1}^{8760} E[hi] = \sum_{i=1}^{8760} \sum_{j=1}^n E_j[hi] \quad (73)$$

5.2.2.2. *Verification and calibration of the proposed methodology*

Energy bills

The last phase of the simulation is the calibration. Calibration is performed using actual monthly consumption data. On this stage, the simulator predictions are compared with the actual consumption data and two mechanisms have been incorporated to manage the deviations between actual and predicted consumption and cost. Energy use (kWh) is calibrated by adjusting the time use percent-ages, while energy cost (€) is calibrated by shifting loads into cheaper/more expensive device profile hours.

The energy use for a billing period (m hours) by all the devices identified is calculated as:

$$Ep = \sum_{i=1}^m E[hi] = \sum_{i=1}^m \sum_{j=1}^n Ej[hi] \quad (74)$$

where Ep is the total energy use for the billing period and m is the hours of billing period. On the other hand, energy cost for a particular hour is estimated as:

$$C[hi] = E[hi] \times P[hi] \quad (75)$$

where $E[hi]$ is the energy use for the particular hour and $P[hi]$ is the energy price for the particular hour by considering the tariff schemes.

Energy use calibration: adjustment of the time coefficients

For every billing period, the EUM simulator calculates the overall consumption within the billing period via the Eq. (74) (kWh) and compares the overall simulated consumption with the real consumption during the billing period. Any deviation is taken account of by adjusting the time coefficients, within the specific billing period. In this way, by means of this adjustment of the use time percentages, the simulated consumption can be made equal to the actual one.

Energy cost calibration by load shifting

The second calibration step compares the total energy cost, predicted by the methodology within the billing period, with the amount paid in to the electric utility as shown on the bill. This is done by means of shifting loads to a higher or lower pricing zone, depending, respectively, on whether the cost was underestimated or overestimated [149].

Let us consider:

- $E_o(h_i)$ - is the electricity demand, estimated by the simulator
- $P_o(h_i)$ - is the estimated price, calculated and applied to the hi hour
- $C_o(h_i)$ - is the cost of the electricity consumed in the hi hour
- E_o - is the electricity demand, as estimated by the simulator, for the whole billing period
- C_o - is the electricity cost, as estimated by the simulator, for the whole billing period
- E_a - is the actual electricity consumption for the period
- C_a - is the actual cost of electricity for the specific period
- P_w - is the weighted price for the billing period, i.e., the total electricity cost divided by is the total load for the period, $P_w = C_a/E_a$
- E_{peak} - is electricity consumed in higher prices than P_w
- $E_{off-peak}$ - is electricity consumed in lower prices than P_w
- $minC$ - is $E_o \times P_{min}$ equals minimum energy cost for the billing period
- E_{Pmin} - is the amount of energy consumed during minimum price hours within the period
- $E'(h_i)$ - is the electricity demand after calibration in the h_i
- $C'(h_i)$ - is the electricity cost after calibration in the hi hour

For every billing period, the EUM calculates the cost difference ($C_o - C_a$) and the weighted price P_w . If the energy cost in this period is overestimated, EUM calculates the required amount of energy (E_{shift}) to be shifted for C_a cost as a ratio of the total load within the period.

$$E_{shift} = \frac{(E_o - E_{Pmin}) \times (C_o - C_a)}{C_o - minC} \quad (76)$$

EUM calculates the calibrated energy consumption for every hour via equations (77) and (78):

$$E'(h_i) = E_o(h_i) - \left(\frac{E_o(h_i)}{E_{peak}} \right) \times E_{shift}, \text{ if } P(h_i) > P_w \quad (77)$$

$$E'(h_i) = E_o(h_i) - \left(\frac{E_o(h_i)}{E_{off-peak}} \right) \times E_{shift}, \text{ if } P(h_i) < P_w \quad (78)$$

Finally, EUM calculates the new cost of energy for the period as:

$$C' = \sum C'(h_i) = \sum E'(h_i) \times P_o(h_i) \quad (79)$$

A similar process applies to the case of an underestimated energy cost with reverse signs in equations (77) and (78) and using the maximum price, instead of the minimum, in the E_{shift} calculation. $maxC$ and E_{Pmax} should be now calculated and used in (76) instead of $minC$ and E_{Pmin} .

5.3. Software implementation

The previously introduced methodology for microgrid design has been used for the developed μ GM's Energy planning application. As described in Section 4. both Operation scheduling and Energy planning applications, in fact, make the call to the core *Optimization engine* to perform simulation/optimization of the microgrid operation. As stated, the main difference between the two calls lies in the specified time horizon and the nature of inputs, i.e. use of historic or forecasted values.

The core of the developed Energy planning application was developed in Java (Enterprise Edition 6), under the Integrated Development Environment (NetBeans IDE 6.9.1) and deployed on Application Server (Apache/Tomcat 6.0). Energy planning application offers both an intuitive, user-friendly, graphical user interface (GUI) as well as a web service interface oriented towards communication with components from the rest of the overall μ GM system. The GUI was implemented using Java Server Faces (JSF), AJAX and Adobe Flash technologies to facilitate a rich, fast and easy-to-use application development. Moreover, one of the main open source JSF libraries used for the development of this application is Richfaces™. It is an Ajax-enabled component library for JavaServer Faces, hosted by JBoss.org. It allows easy integration of Ajax capabilities into enterprise application development. For the purposes of integration of Flash into Java server side technology, i.e. Java servlets (in order to provide data to Flash applications and send data to back-end data sources), Adobe Flex data access component was utilized. Apart from the previously mentioned, the following list of open-source components was used to support the development of various functionalities, as briefly outlined:

- GMaps4JSF: integration of Google Maps with JSF
- iText: creation and manipulation of PDF documents within Java applications
- Jcaptcha: captcha definition and integration into JSF
- JfreeChart: chart library for displaying professional quality charts in Java applications
- PrimeFaces: lightweight component suite for JSF 2.0 featuring 100+ rich set of JSF components
- Dygraph: JavaScript library for production of interactive, zoomable charts of time series
- Jersey - Sun's reference implementation for the Java API for RESTful Web Services

The business logic is implemented with over 150 Java classes, divided into 18 packages. These packages and their roles in the simulator are listed below and graphically presented in Figure 24:

- Beans: Contains JSF backing bean and business logic classes
- Captcha: Contains classes used in the implementation of Captcha challenge-response test.
- Datatypes: Contains classes, which are used to transfer the data to and from JSF pages.
- Reporting: Contains classes, which are responsible for the creation of simulation reports in PDF format.
- Validator: Contains classes, which ensure the validity of input data from JSF pages.
- DAO: Contains classes, which communicate with EWS database and perform retrieval and storage operations for objects. This package communicates with the EWS database using the corresponding JDBC driver.
- transferObject: Contains classes, which are used to transfer the data from EWS database to the business logic component.
- Flash: Contains classes, which perform the communication between Adobe Flash and JSF pages.
- GMaps: Contains classes, which enable EWS to use the potential of Google Maps.

- Controller: Contains classes used by the simulation algorithm for the optimization of produced and consumed energy management.
- Validator: Contains classes which validate various user input.
- MCDM: Contains classes required for execution of the multi-criteria decision making algorithm.
- Entities, service, wrapper: Contains classes responsible for communication with designated controller using REST-full approach
- Calibration: Contains classes, which are used to validate and calibrate models and algorithms with measurements.

The following are several screenshots from the developed application.

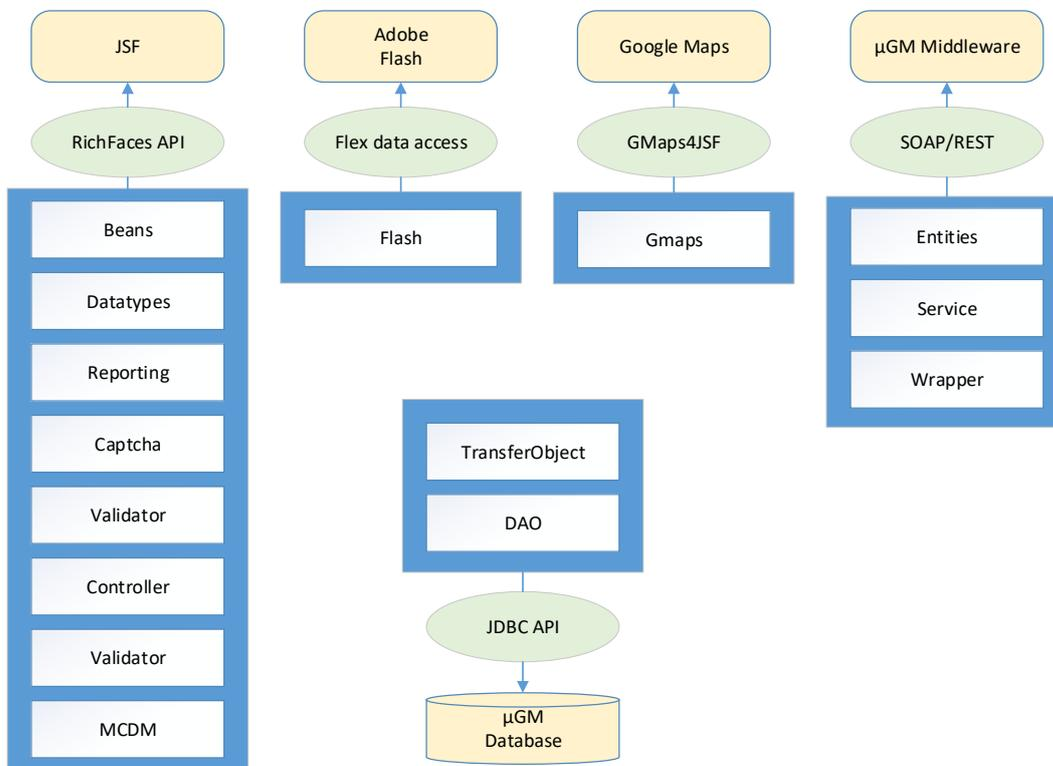

Figure 24. Simulator Java packages and their roles

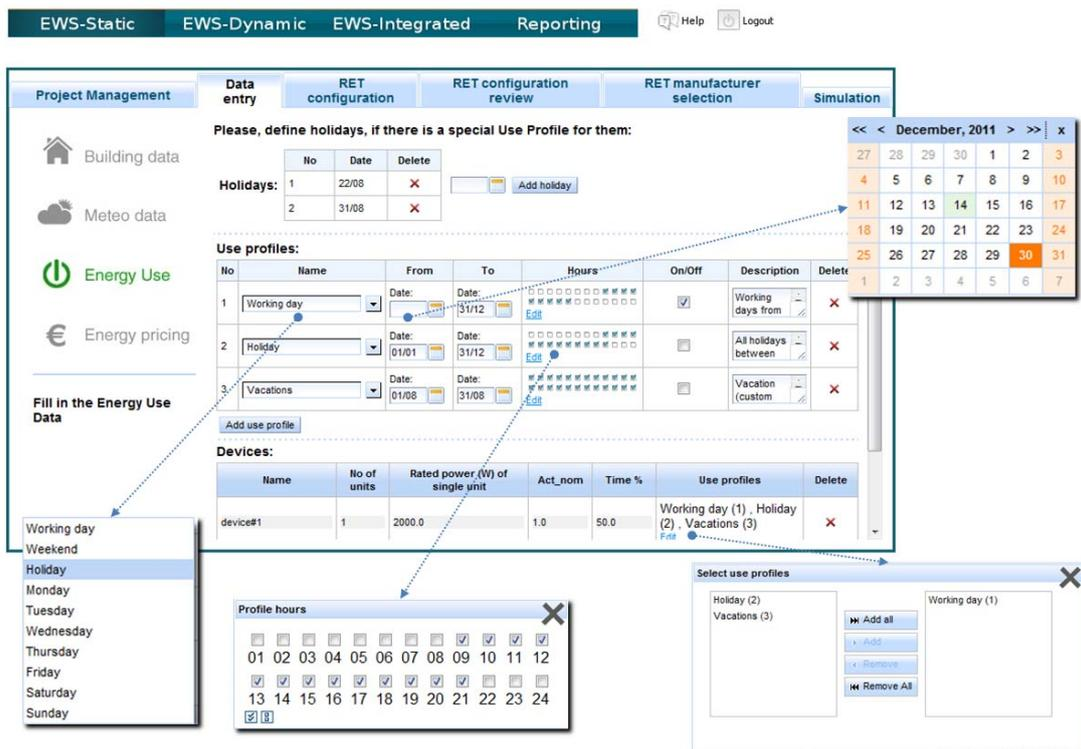

Figure 25: Module for energy demand modelling

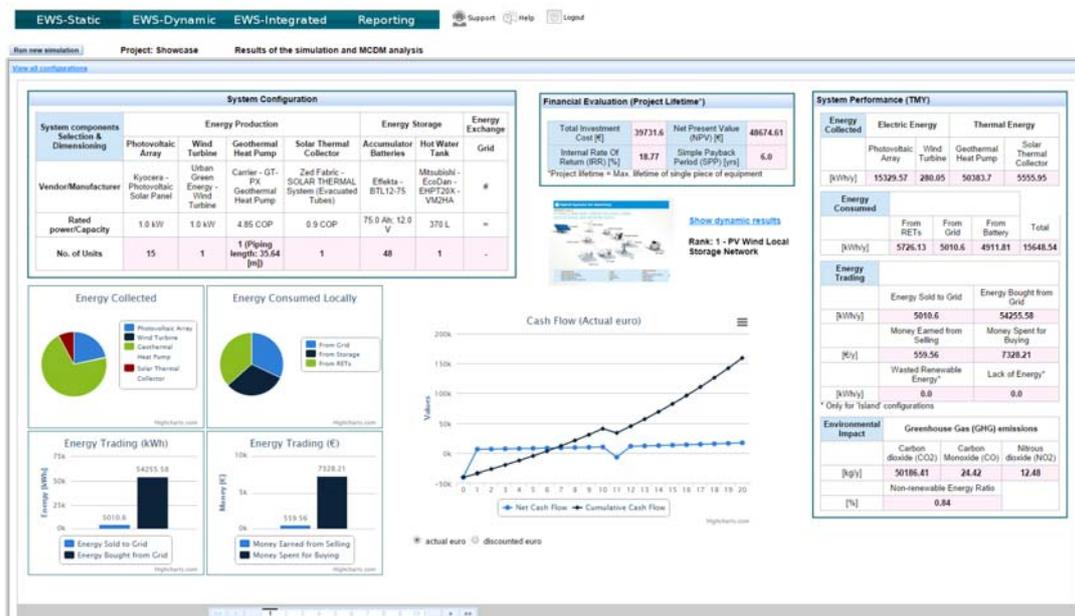

Figure 26: Final output from Energy planning

The software was extensively tested and validated, and successfully used in several EU projects (Energy Warden, CASCADE, RESPOND, etc.) afterwards.

6. Application of proposed solution and impact validation

The practical application of the thesis developments is demonstrated in real-world use-case scenarios. To grasp the full potential of the developed ontology-based facility model in terms of semantic interoperability and enabling advanced energy efficiency measures, its application was demonstrated in the context of the two EU airports. Their infrastructures were modelled according the actual data. A real world use case was devised to show how contextual knowledge could be employed to enhance Fault Detection and Diagnosis (FDD) algorithms.

On the other hand, the entire μ GM architecture was deployed at the Institute Mihajlo Pupin and the microgrid management functionality was tested and validated for an actual building within the Institute's campus. The Institute was chosen as it represents a multi-carrier environment featuring on-site generation from solar photovoltaic plant, access to the power grid, local thermal plant running on fuel oil and complex heating system capable of switching between carriers.

6.1. Semantic integration of legacy EMS with advanced energy services at Malpensa and Fiumicino airports

The flexibility of the proposed facility modelling approach reflects the possibility to instantiate any complex infrastructure, starting from the core facility ontology. This procedure includes first extension and then population of the core facility ontology, according to the actual state of the target facility. For the purpose of modelling the test-bed platform, airport infrastructures were chosen. Airports, serving as the critical transportation infrastructure nodes, are significant energy consumers and emission producers. Owing to their rather complex infrastructure, technical characteristics and different aspects of the existing devices and modules installed at the site, two major European air-traffic hubs, MXP airport in Milan (with total yearly electricity consumption of 140GWh) and FCO airport in Rome (with total yearly electricity consumption of 176GWh) were analysed (shown in Figure 27). Therefore, two airport ontology instances were developed, representing the facility models of MXP and FXO airports. Various data sources, such as technical sheets, equipment manuals, audits, questionnaires and

interviews, were used to acquire the input data, which were then transferred to the ontology [150]. More precisely, based on the gathered data, the core facility ontology model was first extended and then further populated into two separate ontology instances. These two ontology instances, built upon

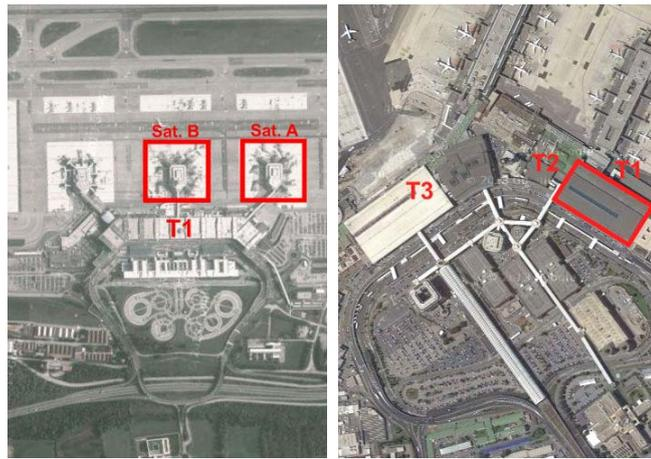

Figure 27: MXP and FCO airports (target areas)

the core facility ontology, represent two full-blown airport ontology models, tailored to reflect the actual state of the chosen airports. Extended class hierarchies of these two full-blown models are shown in Figure 28 (where additionally defined entities are marked with yellow). Serving as the central data repository of the overall μ GM solution, the airport ontology was used to store all the static data, regarding the target systems and significant energy users (such as nominal air supply flow, fan drive power, air flow frequency of AHUs etc.), which could be exploited further by an advanced energy analytics algorithm, such as FDD or to calculate potential energy waste due to detected faults.

6.1.1. Airport ontology population

For the purpose of the ontology population, detailed facility technical characterization was performed. Gathered data were transferred into the airport ontology, by instantiating the ontology entities with associated property values and relations. In order to provide the means for semantic interpretation of signals coming from the field devices, all signals extracted from the data-point list of the main BMS (more precisely, the DESIGO system, which currently operates at both airports as the main platform for supervision and control [151]) were instantiated as corresponding control or reading signals. Apart from other parameters, every signal instance was defined with a unique identifier from which required additional semantics were extracted, in a fully automated manner, by querying the ontology. Furthermore, for semantic enrichment of low-level signals, different information needed to be instantiated, starting from the technical system (such as AHU, water loop system etc.), over the device or functionality which triggers some event or

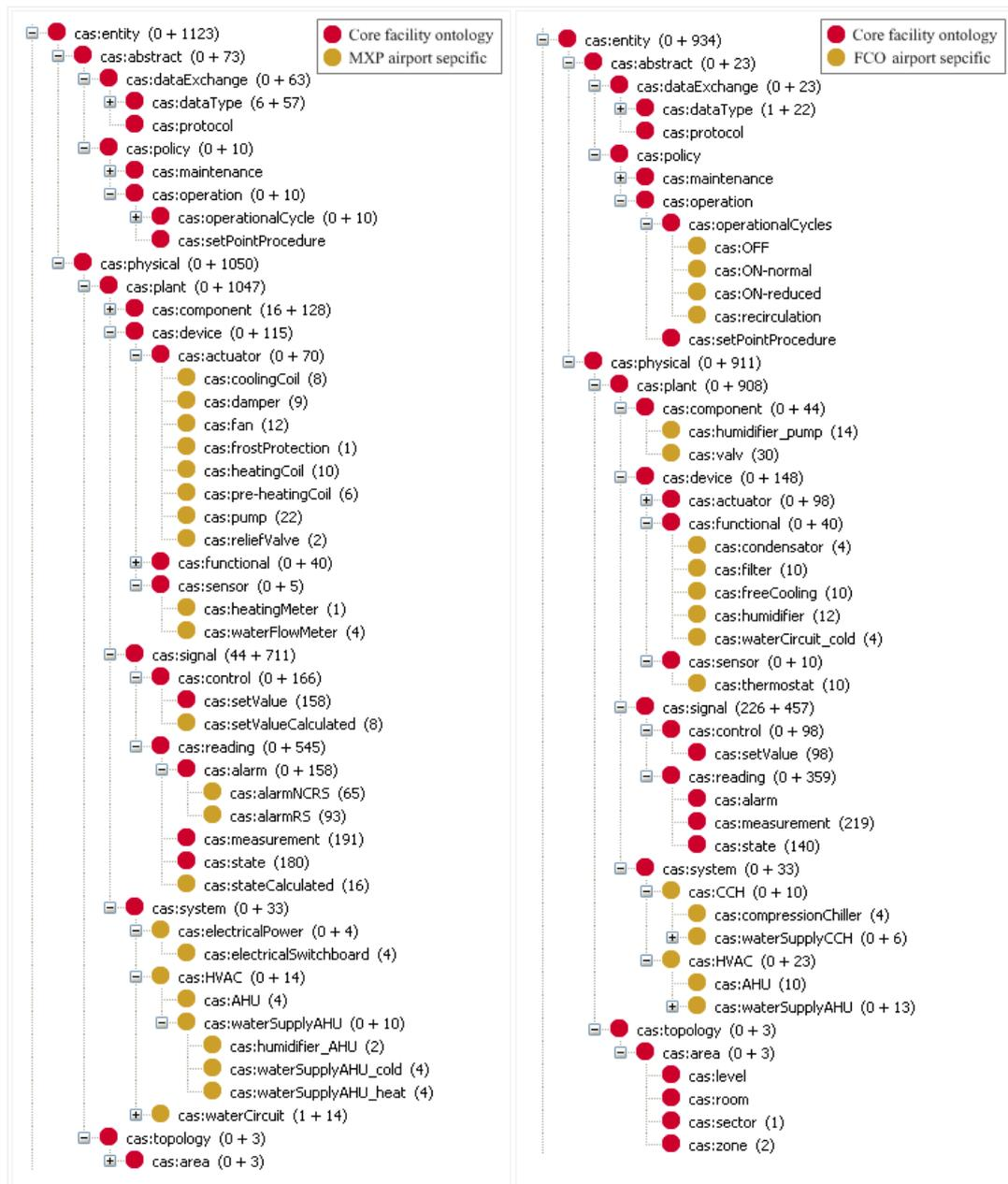

Figure 28: Airport ontology for MXP (left) and FCO (right)

signal (such as cooling/heating coil modelled as actuator or signal instances such as pressure drop, exhaust fan alarm etc.), to corresponding measurement type (such as ambient temperature or humidity defined as reading signals).

For the modelling of the information about the physical placement of devices and associated signals, airport infrastructure and its premises (offices, waiting halls etc.) were mapped and instantiated so that they reflected the actual state of the airport. Each topological area was defined with corresponding parameters, indicating its

interconnection and geographical position with respect to other airport premises. By mapping devices and signals to the associated topological entity, it was possible to extract the information about the location of a specific physical entity.

For the population of airport ontology instances, representing MXP and FCO airport facilities, specific target airport areas (shown in Figure 27) were taken into account. In case of the MXP airport, the instantiation of satellites A and B (holding 16% share of total energy consumption) as parts of the Terminal 1 (T1) building was performed. Mapping of corresponding target devices (such as double duct AHU group 20 located in Satellite A, water side substation 4 and 5 located in Satellite A and B, respectively) was carried out according to the detailed airport facility 2D plans. T1 of the FCO airport (holding 13% share of total energy consumption) with associated equipment (containing target devices such as AHU groups 1 to 12, compression chillers 1 to 4 etc.) was used for the population of the corresponding ontology instance. Relevant statistics of the populated airport ontology instances, such as number of classes, instances and properties/relations, is presented in Table 5. Once the airport ontology was populated, semantic queries were defined and utilized for the extraction of the data from the ontology, as it was described in the previous section.

Both extension and population of the core facility ontology were carried out based on the BMS data point lists, carrying the information about every low-level signal that the EMS framework might have to deal with. Since at both airports, signals were complied with the Unified data point naming convention [150], alignment of the airport ontology was carried out accordingly. This included mapping of the data point property value (such as signal identifier, data type, source etc.) into the airport ontology, as the entity instance or property value.

Table 5: Airport ontology statistics

| Complex infrastructure | Classes | Properties | | Instances |
|------------------------|---------|------------|-----------|-----------|
| | | Object | Data-type | |
| Malpensa Airport | 119 | 16 | 46 | 1123 |
| Fiumicino Airport | 73 | 16 | 69 | 934 |

6.1.2. Ontology API parameters

The airport ontology could be applied by facilitating the manual user input for definition of corrective actions to creating the high-level energy saving messages, which contain precise information about the critical device. In any case, the extraction of the additional semantics was performed automatically, by querying the ontology based on the corresponding input argument, such as, for instance, a signal identifier indicating the critical system or device, and predefined API functions with embedded SPARQL queries. Therefore, as a part of the specification of the ontology API, it was necessary first to define parameters/data relevant to be extracted and further exploited within the energy management framework. The excerpt of the full-blown list of parameters (with corresponding source ontology entities), which were determined as relevant and provided through the API of both the MXP and FCO airport ontologies, is shown in Table 6. Through the ontology API functions or, more precisely, by using the SPARQL queries embedded within, these data were available on demand and used to assist the creation of the high-level energy saving messages for the end-user, for FDD system integration and interactive visualization of the critical device related information.

Table 6: Ontology API parameters

| No. | Parameter | Ontology entity |
|-----|-----------------------------|---|
| 1 | System name | class:system |
| 2 | Subsystem name | class:device |
| 3 | Device name | class:component |
| 4 | Location | class:topology |
| 5 | Sub-location | class:topology |
| 6 | Location related parameters | property:area_description,property:area_m2,property:volume_m3 |
| 7 | Technical data sheet | property:technicalSheet |
| 8 | Signal type | class:signal |
| 9 | Sensor ID | property:signal_id |
| 10 | Source | property:source |
| 11 | Signal description | property:signal_description |
| 12 | Signal related prms. | property:data_type,property:medium,property:position |
| 13 | Nearby devices/signals | property:locatedAt |

6.1.3. Energy saving messages

To increase the awareness and consequently the overall energy efficiency, “content rich” energy saving messages, carrying the precise information about the potential energy conservation opportunities detected by the FDDs, were developed. Such “content rich” messages were compiled and visualized to the end-user as part of the ISO 50001 energy management guidelines [12], [14]. They were composed by extracting the additional semantics, i.e. parameters listed in Table 6, from the ontology. These parameters were extracted in a fully automated manner, simply based on the signal identifier (unique ID of a specific low-level signal) coming from the faulty device and presented in an intuitive and easily understandable manner to the end-user.

The screenshot of the “content rich” energy saving message is shown in Figure 29, indicating a potential energy conservation action/opportunity. This particular example depicts all the information relevant to the energy conservation measure, which should be carried out and corresponding references (next to the data fields in Figure 29) to the ontology entities listed in Table 6, which were used to extract the corresponding data. As it can be seen from this particular message, the fault was detected on the heating coil valve located at the secondary side of the pre-heating coil of AHU water supply system, within the thermal substation B, serving Terminal 1 of the FCO airport (more precisely, arrivals and baggage claim area). Marked fields represent the additional information extracted from the ontology, based on the signal ID, which was provided through the metadata, sent from the field devices and FDDs. However, the information sent through the metadata is usually represented by unintuitive entity acronyms and therefore the airport ontology was used to deliver and present this information in natural language, as shown in Figure 29. For instance, the following is the signal identifier FCO_T1_CCH.02_CTO.TE01__RET_MEA_T, representing the sensor measurement of the cooling tower return air temperature, according to the unified data-point naming convention, which is meant for data exchange among system components and not for the presentation to the end-user. In that way, by extracting the additional semantics related to the detected fault from the ontology, precise high-level information was shown to the end-user in an understandable form in order to initiate appropriate corrective actions and stop further energy leakage on time.

Action Content

Please enter the following information to create a Improvement Opportunity document.
The information with * must be filled in order to submit or save the form.

Requestor: Mark McCaffrey

Basic Information

Action Title: A short summary of the opportunity

Priority/Severity: Please select the priority/Severity.

Reference: System will add the reference after saving or submitting the form

Fault description/diagnosis: Please enter the fault description & diagnosis

Time Stamp: System will add the time stamp after saving or submitting the form

Location: 4 Please select the location

Sub-Location: 5 Please select the sub-location after you have selected the location

Area Description: 6

Surface [m2]: 6

Volume [m3]: 6

System name: 1 Please select the system name.

Sub-System name: 2 Please select the sub-system name.

Device name: 3

Sensor ID: 9

Signal type: 8

Source: 10

Signal description: 11

Medium: 12

Position: 12

Data type: 12

Unit: 12

Measurement range: 12

Data Sheet: 7

Adjacent sensors (ID): 13 Please enter the sensor names

Trends and data:

Technical data sheet for component/system:

Action Category: Please select the action category

Action Sub-Category: Please select the sub-category after you have selected the category

Significant Energy User: Please select the SEU first, then open it by clicking "Open SEU"

Attachments: - None -

Figure 29: “Content rich” energy saving message

6.1.4. Ontology validation considerations

Owing to the comprehensive impact of the proposed ontology-based facility data model, its validation has to be considered from both internal and external perspectives. These two validation dimensions are elaborated in more detail in the following.

6.1.4.1. Internal validation

When it comes to the internal validity of the developed ontology, its purpose is to ensure that all defined concepts are viable from a technical viewpoint. This means that consistency verification of the ontology model and its concept interdependencies against the real pilots is necessary. Although the facility model was leveraged based on physical inspection of both facilities, interviews with airports' personnel and available documentation, a certain degree of inconsistencies and errors inevitably emerge during the modelling process. For instance, ontology errors manifest themselves when there is an incorrect association between a particular system and different low-level devices, e.g. between an HVAC system and humidifier. To prevent this, an online validation was performed during the entire ontology design process. This was achieved by using a range of "semantic rules" (SWRL rules), together with an inference engine which provided reasoning over any new entry in the model. As already mentioned, this represents one of the main functionalities of the developed ontology API. Figure 30 represents an example of the SWRL rule, which ensures that a low-level device or signal, which is part of a particular device, can only be associated with a high-level system to which that particular device belongs as well. Rules like this ensure that semantics of the facility model, interdependencies between devices, systems etc., correspond to the actual situation in the field. The critical importance of performing internal ontology validation can be fully comprehended after considering the challenges of the external validation, elaborated in the following.

```
#rule:(?x pref:partOf_device ?y)(?y pref:partOf_system ?z) -> (?x pref:partOf_system ?z)";
```

Figure 30: Example of consistency check rule

6.1.4.2. External validation

While the internal ontology validation aims at providing a facility model that accurately describes the considered building, external validation seeks to prove the purposefulness of the proposed solution in terms of increasing the energy saving potential of the conventional means, using FDD algorithms.

FDD algorithms were implemented to detect faults quickly, systematically and, as much as possible, automatically before additional damage to the system occurs, and/or before the system fails, or too much energy is wasted [152], [153]. This was achieved by a

measurement-based system, as a combination of continuous monitoring, data collection, visualization and corresponding FDD analysis. Both rule-based and qualitative model-based FDDs were implemented leveraging upon acquired measurements and *a priori* knowledge of a target system (such as AHUs, chillers, heat exchangers etc.). A variety of faults, in terms of type and complexity, could be detected by the proposed approach, depending on the number of monitoring points, models of dynamic processes and *a priori* knowledge of a target system, upon which FDD algorithms are operating.

It is important to know that FDD algorithms are commonly applied to a single device and aim at detecting irregularities in their operation, without any concern of the wider context in which they operate. However, additional saving potential, both in terms of energy and human resources, can be unlocked by considering, for instance, not just a single AHU, but a complex system consisting of several AHUs, serving a common open space, such as those inside terminal buildings of airports.

A simple, yet descriptive, example of a space, conditioned by a pair of AHUs that share common set points and operation strategy, can be used to demonstrate our approach. Namely, the consumed energy of an AHU is proportional to the difference between the room temperature and a given set point. If one of the AHUs were malfunctioning, it would fail to reach the requested temperature or simply would not secure enough airflow at the requested temperature, while the other AHU would try to compensate for this deficiency, in order to preserve the comfort level. This results in higher power/energy consumption for the remaining AHU, although the set point temperature would remain unchanged. This would be understood as a device failure, if the two faults were to be analysed independently. More precisely, two fault signals corresponding to each AHU would come from the FDD tool, suggesting that, seemingly, the group of AHUs is underperforming. Eventually, personnel on site would inspect the referred subsystem and try to isolate the fault among different devices forming the group, costing precious time and imposing economic penalties. This is exactly where the ontology metadata layer may bring comparative advantage, by providing the semantic correlation between the detected fault and the designated (sub)systems. Furthermore, it should be emphasized that the proposed approach could easily cope with more complex scenarios, such as with higher number of AHUs serving entire airport terminals. Owing to the scalability of the proposed approach, the rationale behind it would be exactly the same, as in the case with pair of AHUs (as

described previously), by delivering the semantic relations from the ontology which imply that all AHUs are serving the same space and that one part of AHUs is trying to compensate the malfunction of another.

6.2. Improved operation of IMP energy infrastructure

6.2.1. Physical Layout and Use Case Description

The proposed concept is demonstrated and validated through physical deployment of necessary hardware and software at the premises of the Institute Mihajlo Pupin (IMP), located in Belgrade, Serbia (N44°48'22", E20°30'23"). The IMP has a campus-like structure, consisting of several buildings (containing offices, laboratories and workshops), and a common energy supply infrastructure. The latter comprises a thermal plant, running on fuel oil (mazut) and a local Photovoltaic Power Plant (PVPP), installed on the rooftop of the main campus building. Furthermore, the campus is connected to the public power grid via common transformer station at the low-voltage level (0.4 kV/220 V). Owing to such diversity, in terms of energy supply carriers, the IMP campus is suitable for the application of the proposed concept. The focus for the deployment of the presented approach is one of the buildings within the campus (commonly referred to as the "Blue building"), featuring several offices and a workshop. The layout of the Blue building with relevant common campus infrastructure, which was elaborated previously, is represented in the form of an energy hub in Figure 31. The figure highlights existing energy flows and depicts photos of actual plants and equipment present on site. This building was selected owing to the existing supervision and control of energy assets, which required only a minor additional investment in metering equipment, in order to allow for the unambiguous assessment and validation of impact of the applied control/operation strategies. However, it should be highlighted, though, that the proper validation requires consideration of both local (Blue building) and common IMP campus energy assets, which are laid out in Figure 31.

Following is a brief description of typical operation of the energy assets, depicted in Table 7 and Table 8, with regards to the satisfaction of electricity, heating and cooling requirements of the Blue building. The electricity requirements are primarily served by the power grid, but a significant contribution is also made by the local PVPP featuring the total peak power of around 50 kWp [155], [157]. The locally generated DC electricity

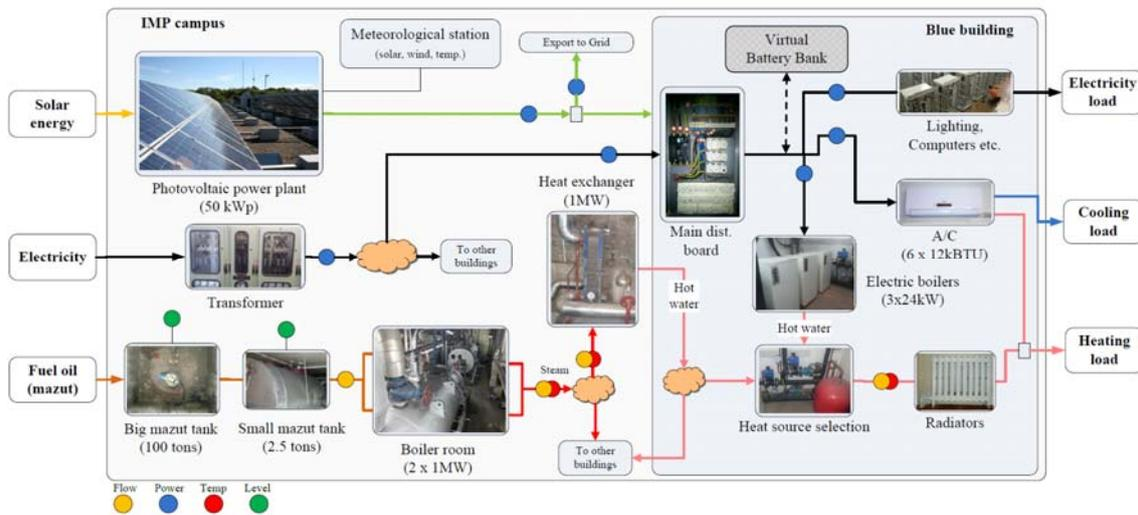

Figure 31: Multi-carrier energy system Use Case (IMP campus)

is first transformed to AC, by means of three inverters, and then either exported to the power grid or used for immediate load fulfilment. In addition, it can be temporarily stored via battery unit, which is foreseen as a future addition to the system.

When it comes to the heating requirements, they are primarily served by radiators running on hot water or, alternatively, by ductless mini split-system air conditioners (A/C). If the radiators are used, the hot water may be delivered either from the common thermal plant or from the local electric boilers, placed in Blue building. In case of the thermal plant, the two fuel oil boilers are first used to produce steam, which is then fed to the heat exchanger, which is used to produce hot water for entire campus consequently. The portion of heat delivered to the Blue building is monitored via corresponding calorimeters. Alternatively, the hot water is

Table 7: Blue building energy assets

| | Blue building energy assets | |
|---------------------|-----------------------------|-------------------------------|
| Type | Electric boilers | Split-system air conditioning |
| Vendor/Manufacturer | Ei ETK-24 | MEH-30LiH2 |
| Power/Capacity | 24 kW | 30 kBTU |
| No. of units | 3 | 6 |

Table 8: Common IMP campus energy assets

| | Common IMP campus energy assets | | | | |
|---------------------|---------------------------------|------------------|--------------------|--------------------|--------------------|
| Type | Photovoltaic Power Plant | Fuel oil boilers | Heat exchanger | Inverters for PVPP | |
| Vendor/Manufacturer | Suntech STP280-24/Vd | Djuro Djakovic | APV Baker AS - K34 | REFUsol | Schneider Electric |
| Power/Capacity | 280W | 1 MWt | 1 MWt | 15 kW | 20 kW |
| No. of units | 180 | 2 | 1 | 2 | 1 |

supplied from the local electric boilers and a switch between the two heat sources is performed by two remotely controlled servomotors, which operate the designated valves to open/close the appropriate branch. Finally, concerning the cooling requirements, there is no centralized air conditioning system for campus, such as those based on chiller machines, due to the old age of the campus buildings and lack of associated air/water distribution infrastructure. Hence, the building is cooled by means of the six ductless mini split-system air conditioning units.

The overall supervision and control of energy flows is based on deployed SCADA system (View4), which communicates with several Remote Terminal Units (pAtlas RTUs) and PLCs (ATLAS MAX) placed in corresponding DC and AC cabinets (all proprietary solutions made by the IMP). The RTUs are then used for data acquisition from a number of sensors and meters, measuring relevant energy flows, as depicted in Table 9. For this purpose, the employed RTUs support several communication protocols and interfaces, e.g. ModBus for inverters, DLMS for main electric meter and M-Bus for ultrasonic meters for fuel oil consumption and calorimeters. The actual placement of the physical meters is illustrated in Figure 31 and each type is marked with different colour: flow (orange), temperature (red), electric power (blue) and mazut level (green). Finally, the RTUs are also used to pass the control commands issued by SCADA system, by acting on the corresponding switches and thus allowing for the remote control of actuators.

The specific objective of the IMP use case consists in developing an operational tool for determining the optimal operation profile of the energy assets located in the hub, as identified in Figure 31. The optimal operation involves minimizing the economic cost associated with load satisfaction, by establishing the best energy source split between locally produced electricity, imported electricity (subject to a dynamic pricing scheme) and mazut, optimally operating the energy storage unit and appropriately scheduling the loads, in compliance with the selected DSM setup. Furthermore, given the diversity of

Table 9: Energy flows monitoring equipment

| Energy flow | Electricity production | Electricity consumption | Fuel oil consumption | Heat consumption |
|-------------------------|--------------------------|-------------------------|-----------------------------|---------------------------|
| Vendor/ Manufacturer | Embedded in inverters | Panoramic Power | SIEMENS Sitrans Probe LU | Danfoss Sonometer 1100 |
| No. of units | 3 | 3 x PAN10, 9 x PAN12 | 2 | 3 |

options to fulfil heating requirements, specific emphasis will be placed on the operation optimisation during the heating season.

One specific feature lies in the stipulated dynamic electricity-pricing scheme, whereby a variable charge is paid for the maximum power intake from the grid over a selected temporal horizon. The charge consists of the maximum electrical power, multiplied by a coefficient which, in turn, varies depending on whether the same maximum has exceeded a certain threshold value or not. The described use case can be cast as an optimisation problem, featuring the energy hub and DSM as model equations and constraints and the operational cost for a selected temporal horizon, as the objective function.

6.2.2. Infrastructure modelling

Starting from the diagram in Figure 31, the IMP use case can alternatively be represented in the form of the energy hub in Figure 32, as detailed in the following. Notice that all model equalities and inequalities, featured herein and in Section 3.3, are taken as constraints for the cost function to be optimised (see Section 3.4). In this respect, there is no distinction between modelling and optimisation, since the former is sufficiently simple (a linear approach is followed) to be employed in the latter.

6.2.3. Numerical Simulation

6.2.3.1. Data and parameters

Numerical values for the system data and parameters are required in order to fully define the model. In particular, the following are required:

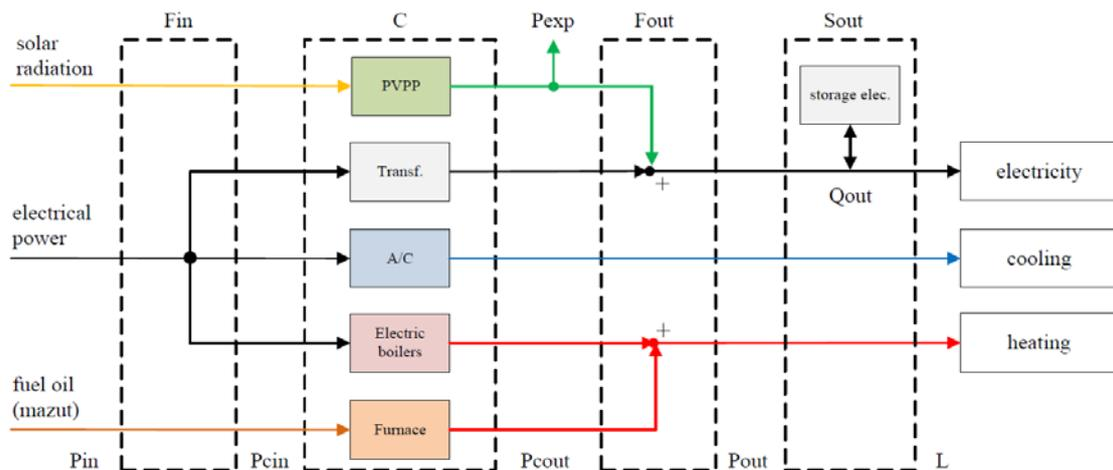

Figure 32: Energy Hub representation of Use Case (IMP campus)

- Dynamic tariff scheme for electricity provision
- Dynamic cost of mazut
- Overall electricity load (including cooling)
- Overall heating load
- Overall electricity production of the PVPP

All the above parameters were captured for the 24-hour period from 00:00 to 23:45, on the 29th of January 2015. The above data time-series were all acquired or reconstructed, by employing a sampling period T_s equal to 15 minutes, for an operation horizon $N = 24 \cdot 4 = 96$ steps (one day).

Electricity prices per unit energy depend on the hour of day, with a “high” value of 4.877 c€/kWh being applied from 08:00 to 24:00 and a “low” value of 2.62 c€/kWh at all other times. Reactive power is priced at 0.97 c€/kVArh (for $0.95 \leq \cos\phi \leq 1$). The power value P_{lim} is set to 30 kW, and the parameters γ_{low} and γ_{high} are respectively equal to 6.7 €/kW and 13.4 €/kW. Although the contracted power limit value is in reality set for the entire IMP campus (currently equal to 300 kW), the considered value for P_{lim} corresponds to the share presumed to be due to the Blue building, as a first order approximation. The cost of mazut fuel is constant and equals to 3.2 c€/kWh. The dynamic prices per energy carrier and per unit energy are depicted in Figure 33. As for the export of electricity, the IMP has acquired the so-called status of *preferential energy supplier* from the Serbian Ministry of Energy, which enables it to participate in the *feed-in* tariff scheme. This allows it to export locally produced electricity from the PVPP at a fixed export price of 23.7 c€/kWh.

For the reconstruction of loads, the deployment of sensors and logging systems (see Figure 31) enables the physical measurement and recording of the electricity demand and heat flows, so that the required data is available to assess daily load patterns. The electricity power meters were distributed across all the relevant devices (electric boiler and A/C units), allowing for the analysis and assessment of the load profile, which is necessary for the application of DSM. As for the heating load, a number of hot water flow and temperature sensors were used to reconstruct the heating load profile (in kWh), as well as to evaluate the efficiency of both the thermal plant (energy conversion from mazut to steam) and the heat exchanger (steam to hot water). Furthermore, the relevant meteorological parameters are also monitored and their profile for the chosen day is

depicted in Figure 34. Concerning the conversion matrix C , the c_1 coefficient should reflect the conversion from solar energy to electricity. However, given that the output from the PV unit is directly measured, the value of c_1 is set to 1.0 and the actual (measured) electricity inflow is taken as input to the hub. The conversion coefficient c_2 of the transformer is set to 97% and for the A/C units c_3 is set to 80%. In the case of electric boilers, the conversion efficiency of electricity to heat is estimated at $c_4 = 94\%$, based on the manufacturers' datasheet, and the overall efficiency of the thermal plant is evaluated at $c_5 = 72\%$, based on data acquired by the deployed calorimeters. The battery features an energy capacity of 10 kWh and a charge/discharge rate of 3 kW.

For the DSM formulation, featured in (11), the value $M=11$ was selected, equivalent to a 3 hour sliding window ($M+1=12$ steps), during which the cumulative energy must remain the same before and after application of DSM actions. The length of the sliding window was taken as an assumption with respect to the fact that wider window would result in significant changes of the load profile, commonly not acceptable by the building users, whereas narrower window would leave little room for changing the load profile and thus hinder generation of cost savings.

The boundary values for admissible load variations used in (20) are calculated separately for electricity and heating. For the electrical load, ΔL_{max} is set to 0.9 kW, which corresponds to the rated power of reschedulable servers. In the case of heating, maximum load deviations were obtained using the expression (25).

A temperature bandwidth of $\pm 1^\circ\text{C}$ was selected, as it corresponds to the level of room temperature variations that are allowed by comfort class A in ISO 7730 [159], and the

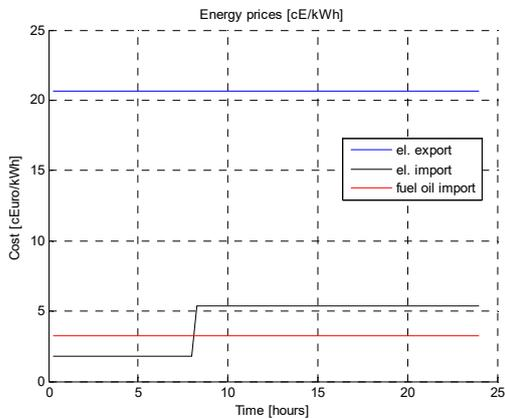

Figure 33: Applicable pricing for energy import/export

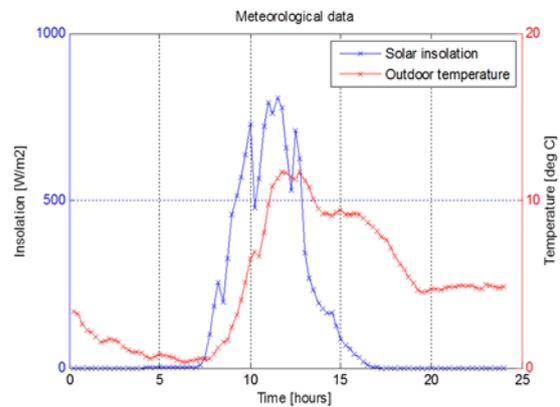

Figure 34: Solar irradiation and temperature

corresponding heating load margins are illustrated in Figure 35, as derived from the model described in Section 3.3, which was numerically modelled in Matlab®Simscape®. The employed building and heating load models are instantiated according to numerical parameters for the building geometry, reported in Table 10. The parameters depict a simplified building model with three types of surfaces (Walls, Roof and Windows), where the floor is considered to be ideal, i.e. it does not feature any heat losses, and is thus omitted from consideration.

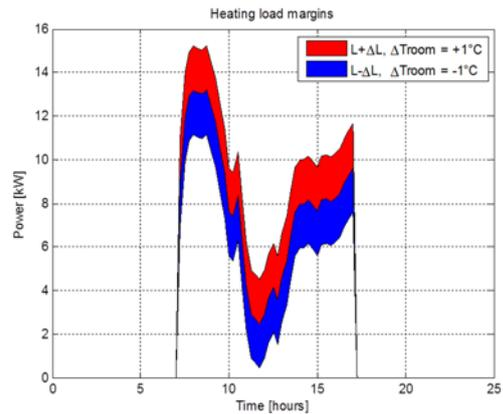

Figure 35: Heating load margins for $\Delta T_{room} = \pm 1^\circ C$

6.2.3.2. Implementation

The proposed holistic energy management approach was implemented according to a generic architecture depicted in Section 2. It consists of three main parts, starting with a pre-processing stage, the key component of which is the Forecaster module, which takes into account the weather forecast, historical energy demand data, models of different renewable energy sources and applicable pricing schemes, to produce all input data required by the energy dispatch optimisation. The following stage is devoted to the actual scheduling and optimisation, which entails an overall mathematical model of the given energy infrastructure, together with routines for simultaneous numerical optimisation of supply and demand side variables. Given the flexibility and reusability of such

Table 10: Parameters for building and heat load modelling

| Building geometry | Walls | Roof | Win. | Air |
|--|--------|-------|------|------|
| Area A_i [m ²] | 320 | 601 | 8 | - |
| Thickness D_i [m] | 0.2 | 0.2 | 0.01 | - |
| Mass m_i [kg] | 122880 | 3846 | 162 | 1496 |
| Building thermal properties | Walls | Roof | Win. | Air |
| Specific heat c_i [J·kg ⁻¹ ·K ⁻¹] | 835 | 835 | 840 | 1005 |
| Thermal conductivity λ_i [W·m ⁻¹ ·K ⁻¹] | 0.038 | 0.038 | 0.78 | - |
| Heat transfer coeff. h_i [W·m ⁻² ·K ⁻¹] | 15 | 9 | 14 | - |

optimisation engine, it was developed as a separated and independent component. Lastly, the management and control stage assesses the optimisation outputs and performs the desired control actions by acting on the automation and control system (i.e. SCADA).

However, results presented in this thesis are not based on forecasted data, but rather on actual measurements, to avoid an interference or uncertainty due to forecast errors (e.g. meteorological conditions, energy demand) and to assess the performance of the proposed optimisation scheme, implemented in SEM, unambiguously. The latter is modelled in Matlab® environment by defining the linear programme consisting of minimizing (26) subject to (1)-(19), as defined in Section 4.3.1. The optimisation problem itself is solved by porting the model to CPLEX®, which is an industry-standard optimization software based on mathematical programming technology [162], equipped with a flexible programming interface that facilitates the development and deployment of applications such as the proposed EMS.

6.2.4. Optimisation results

6.2.4.1. Baseline approach

In order to evaluate properly the potential impact of the joint application of EH and DSM concepts, a baseline control approach, based on simple operating rules, was devised to serve as a reference. The baseline operation of the energy system at the IMP's Blue Building considers that heat demand is completely covered by the heating plant, while the electricity demand is satisfied either from the grid or from local PVPP, depending on the import/export price. Although heat demand can also be covered via existing electric boilers, their use was limited to back-up supply, in case the heating plant fails, or the times when the plant is normally not working (e.g. during the weekend). The overall baseline operation is depicted in Figure 36, by providing time series of four key system variables over a 24 hours period. Distribution of energy demand across different energy carriers is given in Figure 36a. Given that the optimisation is conducted for a winter day, the demand is reduced to heating and electricity. The former originates from maintaining indoor temperature at a desired level (i.e. 21°C), while the latter is primarily coming from the use of electronic equipment inside the building (PCs, servers, lighting etc.). The matching energy supply is depicted in Figure 36c and is comprised of electricity imported from the grid, locally produced electricity from the PVPP as well as heat from the local

heating plant running on fuel oil (mazut). When it comes to energy export featured in Figure 36b, a simple, yet reasonable, heuristic was adopted, i.e. to export all locally generated electricity whenever export price is higher than purchase price or to use it locally otherwise. Owing to the high feed-in tariff (export price) for photovoltaic, which well exceeds both “low” and “high” import electricity prices, all locally produced electricity is exported to the grid, while much cheaper energy is bought from the grid to satisfy the local demand.

Regarding the virtual electricity storage, it is managed according to another simple heuristic-based algorithm, which stores energy during the “low” tariff period, i.e. during night in this case, and releases it in the “high” tariff period (peak hours), to satisfy the demand at the maximum charge/discharge rate. Furthermore, in order to provide for fair comparison among different operation strategies, an additional constraint was set, i.e. that net energy going in and out of the battery during the 24-hour period is equal to zero. Otherwise, any additional energy remaining in the storage, compared with the initial state

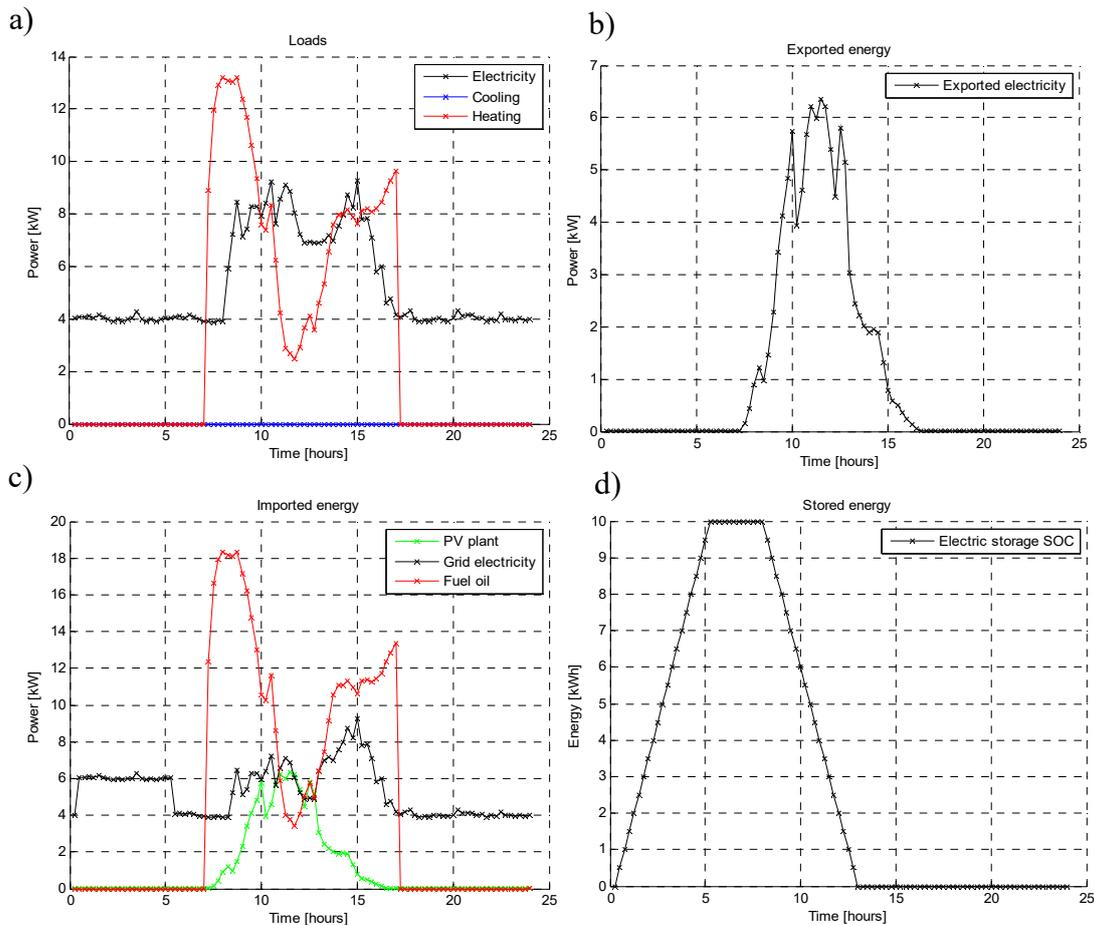

Figure 36: System baseline operation (No EH, No DSM)

of charge (SOC), would impact the measured cost effectiveness of the proposed operational strategy. The baseline storage management is depicted in Figure 36d with the corresponding SOC profile. Bearing all the above in mind, the heat demand is fully satisfied with the heat from the local heating plant while the electricity demand is satisfied partly from the grid and partly from the storage, while the entire locally generated electricity is exported to the grid. The notable deviation in the electricity supply and demand profile (Figure 36a and Figure 36c) during the night and morning hours matches the period of storage charge and discharge, respectively. The outlined algorithm was adopted owing to its cost effective approach and its robustness when utilized for different demand profiles.

6.2.4.2. *Integrated optimisation*

In the case of the integrated optimisation approach, the profile of the four key system variables is depicted in Figure 38. Starting from the demand, Figure 38a includes the baseline profile (full line), together with the proposed DSM changes (dashed line). By comparing the two lines, one can notice a significant change in demand in the morning hours from 07:00-09:00 (circled in red). This is due to the fact that the optimisation scheme aims at satisfying the increase in heating demand by exploiting the low electricity price level, which is active until 08:00, by shifting the load to an interval preceding this hour of the day. The featured variation in the heating demand may be interpreted as a common procedure of pre-heating, which takes advantage of the allowed change in the room temperature. The operation of the PVPP (export) remains the same as in the baseline case, as depicted in Figure 38b, since the level of export prices remained much higher than for import. The battery SOC profile is displayed in Figure 38d, where it can be seen that it essentially mirrors the electricity price levels.

The integrated approach yields a relative improvement of about 11%, if compared with the operating costs associated with the baseline. Although the presented results hold for the selected sample day, similar values hold for other days during the heating season, which feature comparable load patterns and demand profiles.

6.2.4.3. *Modified prices scenario*

As an additional case study, the given scenario was altered by considering a slightly changed electricity-pricing scheme compared to the one defined in Section 6.2.3.1.

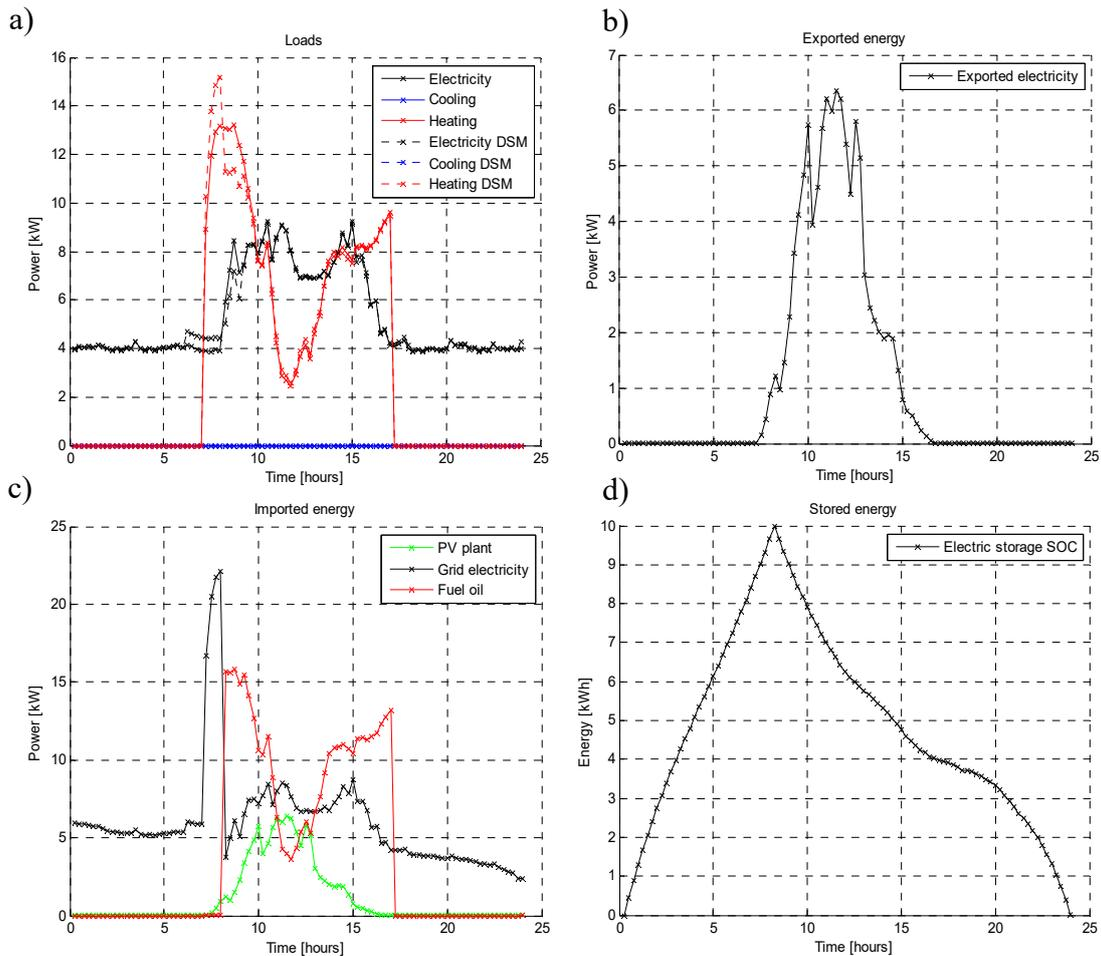

Figure 38: Optimization results for joint application of EH and DSM

Specifically, the new pricing profile considers additional price peaks during midday and evening hours, as depicted in Figure 37. For this new scenario the baseline approach employs the same heuristic-based algorithm for electricity storage, i.e. to store electricity during the “low” tariff period, defined in Section 6.2.3.1, (at night), and release it whenever the price exceeds that tariff. The baseline operation yields practically the same outputs as the ones given in the Figure 36. The reason for this is that the battery is discharged immediately after the electricity tariff exceeds the “low” tariff value, without being

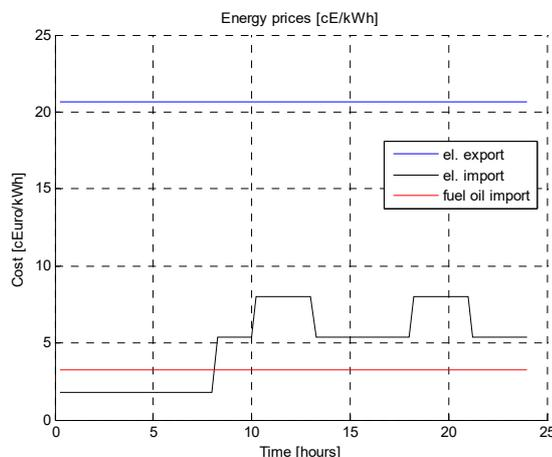

Figure 37: Variable price of electricity and fuel oil

aware that the price still has not reached its maximum value and that it would be more reasonable to store energy a bit longer. On the other hand, the proposed integrated optimisation paradigm does take into account the dynamically varying prices and makes the optimal energy dispatching decisions accordingly, as depicted in Figure 39. This is reflected in Figure 39d, which shows that the battery is discharged mainly during the hours when the highest tariff is applicable. Furthermore, the DSM recommendation for the electricity load becomes more sophisticated than in the previous scenario, as it lowers the load in the period of the peak price, as circled in red in Figure 39. As a result of more sophisticated load and battery management strategy, even slightly higher cost savings were achieved (almost 15%), than with the baseline method. Admittedly, by using a somewhat smarter heuristic, it is possible to improve the baseline performance. For example, one could devise an algorithm that charges the battery during the night (low tariff) and discharges it during the day, but only in the highest daily tariff. As a result, a

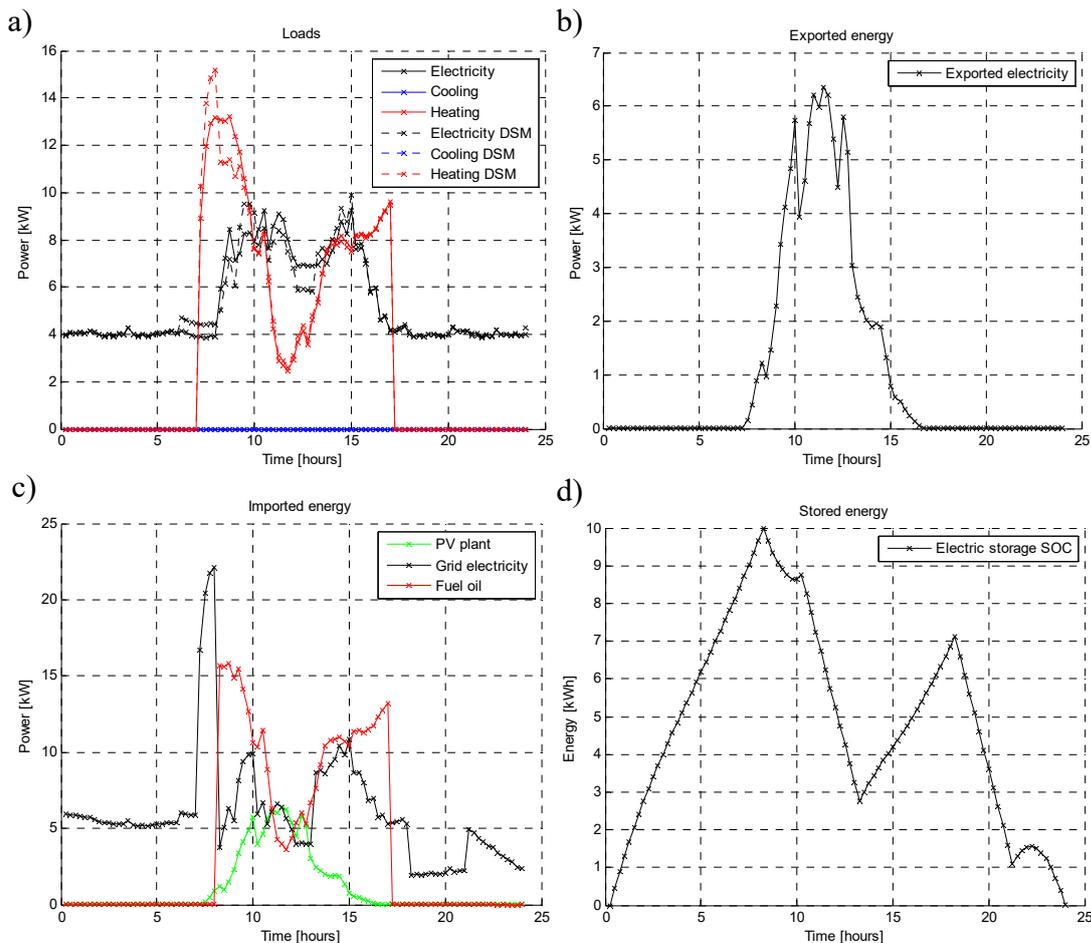

Figure 39: Optimization results for joint application of EH and DSM (modified prices scenario)

somewhat more sophisticated baseline battery operation is employed, yielding the SOC profile depicted in Figure 40. With this strategy the relative benefit, yielded by the integrated optimisation approach, decreases to about 12%. One could arguably derive some other heuristic for the baseline approach that yields an even higher degree of performance, and therefore an even lower degree of relative improvement

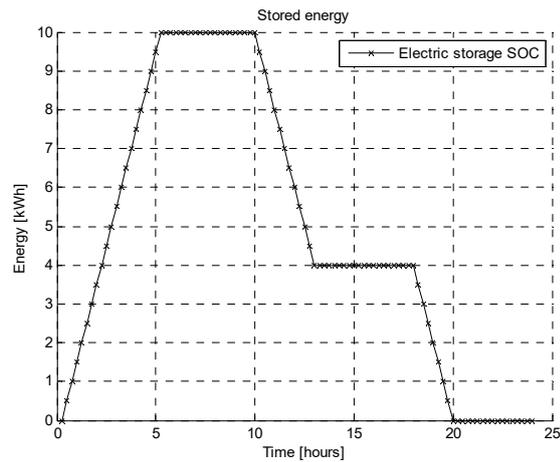

Figure 40: SOC profile for improved heuristic baseline

for the proposed method. However, the price profile might change on a seasonal, weekly, or even daily basis, depending on contractual stipulations, as will the load, so that the heuristic might have to be adapted on an almost daily basis, depending on operating conditions, to avoid performance degradation. This would, in turn, imply extensive tuning and calibration procedures, which would be rather empirical in nature and require several trial and error tests, without any guarantee of conclusively reaching the optimum solution. The proposed model/optimisation based approach is therefore inherently comprehensive and systematic, and exemplifies what can be realistically achieved with interconnected and integrated infrastructure, by using application-ready tools and concepts.

6.2.4.4. Discussion

This previous section presents a holistic energy management paradigm that merges supply and demand perspectives into a unified approach by exploiting the energy hub concept and DSM schemes. The applicability of the proposed concept has been shown based on data, parameters and problem characteristics acquired from an actual building in Belgrade, Serbia. The analysis was conducted for a sample winter day and cost savings exceeding 10% were achieved, if compared to a heuristic based method, with comparable results for other days during the heating season. Furthermore, the proposed approach can be easily adapted to cases with varying pricing schemes or load patterns. Thus, this exemplifies what it is possible to achieve if an integrated model-based optimisation approach is employed, specifically in the case where it is possible to, at least partially, reschedule some of the load.

7. Conclusions and future work

7.1. Discussion on achieved results

The overarching objective of this thesis was to enable improved operation performance of the existing hybrid microgrids, without costly retrofit of its energy assets, but rather through the ICT retrofit and extension of existing supervision and automation tools (e.g. SCADA/BMS/EMS). Moreover, the goal was also to develop innovative microgrid design approaches, which increase their cost-effectiveness. As a result, innovative methodologies, models and concrete software artefacts were developed. The concrete software tools presented in this thesis were developed as a part of a larger, complex, ICT system called μ GM. The μ GM was designed on top of existing supervisory and control systems, aiming to provide the advanced energy analytics and management services. This comprehensive, service-oriented, ICT system takes the advantage of the existing physical systems for monitoring and control and uses them for information retrieval, as well as for forwarding the control actions by connecting to them via software-based communication gateways.

Regarding the improvement of microgrid operation, the microgrid management tool was developed, which serves for scheduling of energy assets within a multi-carrier hybrid energy infrastructure with distributed generation, converters and storages. It is designed to operate in a complex energy infrastructure and to take timely decisions about energy dispatching from on-site generation and imports from the distribution network towards storages and end users, under dynamic energy pricing schemes. The underlying methodology advances the existing approaches by combining demand response schemes with conventional optimization of energy supply for enhanced optimization of microgrid operation. In particular, the presented methodology features modelling of the appliance-level demand response actions which complements the existing approaches by allowing for immediate application of optimization results into the real-world control actions.

This combined approach is validated in an actual building within the campus of the Institute Mihajlo Pupin. Based on this experimental setup, the numerical results show that the combined approach can lead to overall cost savings typically exceeding 10%, compared to a baseline scenario where no energy management solution is applied, i.e. where only a rule-based heuristic is employed to control the available energy assets. This

emphasizes the advantages brought by a systematically integrated modelling and optimization approach.

By leveraging on the same optimization framework, the microgrid planning tool was developed to serve as decision support for optimal RET and DR deployment. The tool takes into account all relevant factors for RET and DR deployment, such as geographical location, energy demand requirements, spatial availability, applicable energy pricing schemes and governmental subsidies and incentives (e.g. feed-in-tariffs), etc. An innovative methodology was employed, which concurrently assesses both electric and thermal energy domains, considers both grid-connected and isolated microgrid configurations, and takes into account flexibility on the demand side to deliver the most cost-effective solution. Moreover, the underlying planning methodology takes into consideration a number of technical, economic and ecological evaluation criteria and assesses them simultaneously. As a part of the planning tool, a detailed and generic environment for simulation of RETs has been developed, based on the state of the art mathematical models, to reinforce the tool with estimation on the long-term energy harvesting potential for specific location.

The microgrid-planning tool also required the development of energy demand model to determine expected load profile. As a result, an innovative energy demand-modeling tool was developed, which leverages user habits and behavior together with the existing energy infrastructure characteristics, rather than employing common building physics approaches. Moreover, the tool uses previous energy costs to calibrate its output. The proposed approach is flexible and scalable enough to support demand modelling on a larger scale such as neighborhoods and districts.

Definition of a comprehensive facility data model, presented in this thesis, primarily aimed at tackling the underlying heterogeneity of complex infrastructures and enabled the semantic interoperability with legacy supervision and control systems. Moreover, besides providing more flexible data interpretation, event management and advanced communication, it also unlocks the potential for advanced controls and dynamic energy efficiency measures. This thesis proposes one of the possible implementations of a facility data model, utilizing the concept of ontology as a part of the contemporary Semantic Web paradigm. The proposed facility ontology was defined and developed to model all the

static knowledge related to the target energy infrastructure. Furthermore, this thesis describes the overall methodology and how the common semantics offered by the ontology were utilized to improve the interoperability and energy management of complex infrastructures. Initially, a core facility ontology, which represents the generic facility model providing the general concepts behind the modelling, was defined. In order to develop a full-blown model of the specific infrastructure, Malpensa and Fiumicino airports in Italy were taken as a test-bed platform in order to develop the airport ontology, owing to the variety of the technical systems installed at these sites. For the development of the airport ontology, the core facility ontology was first extended and then populated to reflect the actual state of the target airport facility. The developed ontology was tested in the environment of the two pilots, and the proposed solution proved to be a valuable link between separate ICT systems, involving equipment from various vendors, both on syntactic and semantic level, thus offering to the facility managers the ability to retrieve semantically enriched information regarding both the structure and the performance of their infrastructure.

To summarize, the significance of the conducted research and developed software is manifold. Considering the microgrid-planning tool can be deployed as an independent, web-accessible, decision support system it can offer the unlimited public access to feasibility assessment and economic appraisal of DR and RET, which may generally contribute to penetration of renewable energy and overall energy supply sustainability. Moreover, optimized planning avoids having under- or oversized infrastructure, which would result in additional unnecessary costs in both cases. On the other hand, the innovative energy management approaches may deliver considerable cost savings over the existing energy infrastructures and thus provide an alternative for the costly retrofit of energy assets, which typically hinders reduction of operation costs.

7.2. Future work

The work presented in this thesis was conducted in the framework of the so-called, “initial penetration phase” of VRE into the conventional power systems. During this initial phase, one of the main objectives was to overcome, at least partially, the economic ineffectiveness associated with deployment of renewables and increase their share in the overall energy production. The examples of the best practices are Denmark with 42%

penetration of VRE, Germany 20%, and California 14% in 2015; however, they still operate in the context of larger, synchronous, AC grids, which they use to export excess power from VRE and as support in maintaining overall system stability¹⁶. Therefore, although stated globally as one of the main sustainability and environmental objectives, transition to “green” energy supply has proven to be quite challenging, not only from the economic perspective, but also from the perspective of various technological barriers, coming from the very nature of existing power systems. Although both capital and maintenance costs for renewable energy projects are constantly decreasing, the original conceptual design of power systems, featuring centralized and controllable energy production, hinders higher penetration levels of distributed VRE. Namely, current research demonstrated that achieving 30% penetration of VRE is possible with minimal system changes. Reaching very high levels of VRE integration (more than 50%), currently only applicable to some geographical islands, is however hindered by numerous technical challenges, such as:

- variability and uncertainty of VRE,
- distributed controls,
- power system stability,
- protection coordination,
- unintentional islanding,
- black-start capability etc.

As an immediate response to the listed open issues, several countries (e.g. Ireland) have established the maximum limit for the so-called system non-synchronous penetration (SNSP), i.e. penetration of VRE, to maintain sufficient synchronous inertia and thus the grid stability and operability¹⁷. Therefore, having 100% of VRE requires a paradigm shift for future power systems, which will leverage innovative power electronics solutions to solve primary synchronization challenges (e.g. smart inverters) and data intensive monitoring to increase system observability, but will also require new architectures and advanced, distributed, management and control systems. These systems will undoubtedly

¹⁶Benjamin Kroposki (NREL), Integrating High Levels of Variable Renewable Energy into Electric Power Systems, *B. J. Mod. Power Syst. Clean Energy* (2017) 5: 831. <https://doi.org/10.1007/s40565-017-0339-3>

¹⁷ International Energy Agency, *Renewable Energy: Medium Term Market Report 2016, Market Analysis and Forecasts to 2021*, 2016.

leverage state of the art artificial intelligence (AI) techniques and algorithms to solve problems of the real-time dispatch, scheduling and operational planning. Moreover, the energy management systems at transmission and distribution levels will need to be able to monitor and control millions of distributed devices, which will require employment of Big Data analytics. Large-scale deployment of monitoring equipment will surely leverage internet of things (IoT) solutions, which will have to be adapted for this particular use.

The focus of the future work, in the context of this thesis, will therefore lie in further application of ICT technologies in power systems. In particular, the future research will be fostered by the three Horizon 2020 research and innovation projects¹⁸, recently acquired by the candidate's research laboratory at the Institute Mihajlo Pupin and will focus on the following topics:

Cloud-based ICT platform for advanced energy services – development of scalable and adaptable software platform, acting as intermediary between a power system or energy service company (ESCO) and the end users. The aim is to facilitate provisioning of advanced energy services, such as demand and distributed production forecasting, supply scheduling, aggregated demand response etc. while, complying with the existing Smart Grid Architecture Model (SGAM). The main challenge will lie in solving both communication and semantic interoperability of diverse protocols used in conventional power grids (e.g. IEC 61850 at plant controller and IEC 61968 or IEC 62325 at grid controller and distributed energy management system), but also the emerging frameworks dealing with demand response (e.g. OpenADR or USEF). For this purpose, a unified (XML-based) messaging format, acting as canonical data model (CDM), will be defined across the system. The CDM will primarily be focused on alignment with common interoperability standards (such as IEC 61970 (CIM), IEC 61850) but also recently introduced SAREF4ENER alignment for Demand Response (CIM/OpenADR), Machine to Machine communication (oneM2M), Smart Meters (DLMS/COSEM), Smart Appliances (SPINE EEBus), thus achieving an extended interoperability scope. Overall

¹⁸H2020 REACT – Renewable Energy for self-sustainable island Communities, 2018-2022
H2020 RESPOND – Integrated demand Response Solution towards energy Positive Neighbourhoods, 2017-2020.
H2020 InBETWEEN – ICT enabled Behavioral change Towards Energy Efficient lifestyles, 2017-2020.

implementation will leverage open source Java and OSGi technologies that provide cross-platform execution environment.

Scheduling and operational planning at community level – development of a holistic, community level, energy management service for the aforementioned cloud-based platform. The underlying algorithms will fully exploit flexibility of cooperative demand response actions (automated and manual) and community level VRE and energy storages. Depending on the adopted energy-related infrastructure models, and chosen decision criteria, a choice will be made to use integer (or mixed integer) programming techniques or appropriate non-linear programming techniques. Moreover, use of dynamic programming technique will be investigated for the purpose of implementation of optimal control approach.

Non-intrusive load monitoring (NILM) – which is used for disaggregation of the load monitored through a single metering point (e.g. smart meter). Such disaggregation enables application of advanced demand response techniques, which are used for short-term planning, or immediate balancing of the system. The underlying NILM algorithms use various, data-intensive, machine learning techniques (e.g. deep or convolutional neural networks). The aim of the research is to improve current NILM approaches but also to investigate optimal software implementation and establish a cloud based service, which will offer NILM functionality.

Local generation forecast – which is required to cope with variability and uncertainty of VRE. The future work will combine the existing deterministic and stochastic approaches with data driven ones that leverage huge amounts of available monitoring data. The investigation will be made to find the most appropriate machine learning and Big Data analytics technique for the problem, as well as to deliver a corresponding cloud base service.

Lastly, the proposed software system architecture, defined in Section 2, is sufficiently generic, flexible and scalable to allow for seamless integration and implementation of energy services emerging in the future. Hence, the currently developing services such as NILM or production forecast will be integrated within the proposed μ GM.

Literature

- [1] G. Beccuti, T. Demiray, M. Batic, N. Tomasevic and S. Vranes, "Energy hub modelling and optimisation: an analytical case-study", *PowerTech, 2015 IEEE Eindhoven*, Eindhoven, 2015, pp. 1-6. doi: 10.1109/PTC.2015.7232413
- [2] Marko Batić, Nikola Tomašević, Giovanni Beccuti, Turhan Demiray, Sanja Vraneš, "Combined energy hub optimisation and demand side management for buildings", *Energy and Buildings*, Vol. 127, 1 Sept. 2016, pp. 229-241, ISSN 0378-7788, <http://dx.doi.org/10.1016/j.enbuild.2016.05.087>.
- [3] Nikola M. Tomašević, Marko Č. Batić, Luis M. Blanes, Marcus M. Keane, Sanja Vraneš, "Ontology-based facility data model for energy management" , *Advanced Engineering Informatics*, Vol. 29, Issue 4, Oct. 2015, pp. 971-984, ISSN 1474-0346, <http://dx.doi.org/10.1016/j.aei.2015.09.003>.
- [4] Maria Kouveletsou, Nikos Sakkas, Stephen Garvin, **Marko Batic**, Daniela Reccardo, Raymond Sterling, "Simulating energy use and energy pricing in buildings: The case of electricity", *Energy and Buildings*, Vol. 54, Nov. 2012, pp. 96-104, ISSN 0378-7788 <http://dx.doi.org/10.1016/j.enbuild.2012.07.031>.
- [5] Dibley M.J., Li H., Miles J.C., Rezgui Y., "Towards intelligent agent based software for building related decision support," *Advanced Engineering Informatics*, Vol. 25, Iss. 2, pp. 311-329, 2011.
- [6] Curry E., O'Donnell J., Corry E., Hasan S., Keane M., O'Riain S., "Linking building data in the cloud: Integrating cross-domain building data using linked data," *Advanced Engineering Informatics*, Vol. 27, Iss. 2, pp. 206-219, 2013.
- [7] Antunes P., Carreire P., Mira da Silva M., "Towards an energy management maturity model," *Energy Policy Journal*, Vol. 73, pp. 803-814, 2014.
- [8] Introna V., Cesarotti V., Benedetti M., Biagiotti S., Rotunno R., "Energy Management Maturity Model: an organizational tool to foster the continuous reduction of energy consumption in companies," *Journal of Cleaner Production*, Vol.83, pp. 108-117, 2014.

- [9] Shen W., Hao Q., Mak H., Neelamkavil J., Xie H., Dickinson J., Thomas R., Pardasani A., Xue H., “Systems integration and collaboration in architecture, engineering, construction, and facilities management: A review,” *Advanced Engineering Informatics, Enabling Technologies for Collaborative Design*, Vol. 24, Iss. 2, pp. 196 – 207, 2010.
- [10] Costa A., Blanes L.M., Donnelly C., Keane M.M., “Review of EU airport energy interests and priorities with respect to ICT, energy and enhanced building operation,” *Proceedings of the 12th International Conference of Enhanced Building Operation, ICEBO 2012, Manchester, UK, 23.-26. October, 2012*.
- [11] McGoveran D., *Embracing SOA: The benefits of integration independence*. Technical report 20060125, Alternative Technologies, 2006.
- [12] ISO 50001:2011. *Energy Management System - Requirements with guidance for use*, Genève, Switzerland, 2011.
- [13] California Energy Commission & California Commissioning Collaborative, *The Building Performance Tracking Handbook: Continuous Improvement for Every Building*, 2011.
- [14] Dorr M., Wahren S., Bauernhansl T., *Methodology for energy efficiency on process level*, The 46th Conference on Manufacturing Systems (CIRP CMS 2013), Vol. 7, pp. 652 – 657, Setubal, Portugal, 29.-30. May, 2013.
- [15] The AIM project, *A novel architecture for modelling, virtualizing and managing the energy consumption of household appliances*, Fp7, [link](#).
- [16] The HYDRA project, *Middleware for networked devices*, Fp6, [link](#).
- [17] The LoCal project, *A Network Architecture for Localized Electrical Energy Reduction, Generation and Sharing*, [link](#)
- [18] The EPIC-Hub project, *Energy Positive Neighbourhoods Infrastructure Middleware based on Energy-Hub Concept*, Fp7, [link](#)

-
- [19] Granderson, Jessica, et al. "*Building energy information systems: State of the technology and user case studies.*" Handbook of web based energy information and control systems (2009).
- [20] McMorran, Alan W. "*An Introduction to IEC 61970-301 & 61968-11: The Common Information Model.*" Glasgow UK, Institute for Energy and Environment - Department of Electronic and Electrical Engineering, University of Strathclyde, January 2007.
- [21] Comer, Ed. "*Canonical Data Model Design Guidelines*" - Phase 2 Update. s.l. ©2010 Michael & Susan Dell Foundation, December 6, 2010.
- [22] Hohpe G., Woolf B., "*Enterprise Integration Patterns: Designing, Building, and Deploying Messaging Solutions*", Addison Wesley, 2003.
- [23] Byrne, Brian, et al. "*The information perspective of SOA design, Part 4: The value of applying the canonical modelling pattern in SOA*", October 2008, [link](#).
- [24] Y. Simmhan, Chapter: "*Semantic Information Integration for Smart Grid Applications.*" Green IT: Tech. and Apps, 2011.
- [25] Smart grid standards map, International Electrotechnical Commission, <http://smartgridstandardsmap.com/>
- [26] "*Smart Grid Set of Standards*", SGCG/M490/G – version 3.1, CEN-CENELEC-ETSI Smart Grid Coordination Group, 2014, [link](#)
- [27] "*SGAM User Manual - Applying, testing & refining the Smart Grid Architecture Model (SGAM)*", CEN-CENELEC-ETSI Smart Grid Coordination Group, 2014, [link](#)
- [28] Smart Grid Interoperability, "*Methodologies to facilitate Smart Grid system interoperability through standardization, system design and testing*", CEN-CENELEC-ETSI Smart Grid Coordination Group, 2014, [link](#)
- [29] "*DSO priorities for Smart Grid standardisation*", A EURELECTRIC / EDSO for Smart Grid joint position paper, Joint Task Force Smart Grid Standardisation

-
- [30] Wagner A, Speiser S, Harth A. “*Semantic web technologies for a smart energy grid: Requirements and challenges*”, In proceedings of 9th International Semantic Web Conference (ISWC2010) 2010 Nov 9 (pp. 33-37).
- [31] Q. Zhou, (2012). “*Semantic Information Modeling for Emerging Applications in Smart Grid*”, 9th Int. Conf. on Inf. Tech.
- [32] A. Crapo, R. Piasecki, and X. Wang. "The smart grid as a semantically enabled internet of things." *Implementing Interoperability Advancing Smart Grid Standards, Architecture and Community: Information Interoperability Track, Grid-Interop Forum*. Vol. 2011. 2011.
- [33] D. Bonino. “*Exploiting semantic technologies in smart environments and grids*”, Sci. Comput. Program 2014
- [34] Santodomingo, R.; “*Ontology matching system for future energy smart grids*”, Engineering Applications of Artificial Intelligence, 2014.
- [35] Hitzler P., Krötzsch M., Rudolph S., Foundations of Semantic Web Technologies, Chapman & Hall/CRC Press, Taylor & Francis Group, 2011.
- [36] Lacy L.W., Owl: Representing Information Using the Web Ontology Language, Trafford Publishing, 2005.
- [37] Studer R., Benjamins R., Fensel D., “Knowledge engineering: Principles and methods,” Data & Knowledge Engineering, Vol. 25, Iss. 1–2, pp. 161–198, 1998.
- [38] White T., Hadoop: The Definitive Guide. Storage and Analysis at Internet Scale, 3rd Edition, O'Reilly Media, 2012.
- [39] Noy N.F., McGuinness D.L., Ontology Development 101: A guide to creating your first ontology, Stanford Knowledge Systems Laboratory Technical Report KSL-01-05, 2001.
- [40] Oberle D., "How Ontologies Benefit Enterprise Applications," Semantic Web Journal - Interoperability, Usability, Applicability, 2009.

- [41] Reinisch C., Kofler, M. J., Felix I., Wolfgang K., “ThinkHome Energy Efficiency in Future Smart Homes,” *EURASIP Journal on Embedded Systems*, Vol. 1, p1-18, 2011.
- [42] Shah N., Chao K.-M., Zlamaniec T., Matei A., “Ontology for Home Energy Management Domain,” *Digital Information and Communication Technology and Its Applications Communications in Computer and Information Science*, Vol. 167, pp. 337-347, 2011.
- [43] Rossello-Busquet A., Brewka L.J., Soler J., Dittmann L.,” *OWL Ontologies and SWRL Rules Applied to Energy Management*,” *UkSim 13th International Conference on Computer Modelling and Simulation (UKSim)*, pp. 446 – 450, Cambridge, England, 30. March-01. April, 2011.
- [44] Grassi M., Nucci M., *Ontologies for Smart Homes and energy management: An implementation-driven survey*, *Workshop on Modeling and Simulation of Cyber-Physical Energy Systems (MSCPES)*, p. 1-3, Berkeley, California, 20.-20. May, 2013
- [45] Rosselló-Busquet A., Soler J., *A Novel Web Service Based Home Energy Management System*, *The 3rd International Conference on Advances in Future Internet (AFIN 2011)*, pp. 126-131, France, 21.-27. August, 2011.
- [46] Tomic S., Fensel A., Pellegrini T., *SESAME demonstrator: Ontologies, services and policies for energy efficiency*, *The 6th International Conference on Semantic Systems (I-SEMANTICS 2010)*, pp.24:1-24:4, Graz, Austria, 01.-03. September, 2010.
- [47] Han J., Jeong Y.K., Lee I., *Efficient Building Energy Management System Based on Ontology, Inference Rules, and Simulation*, *International Conference on Intelligent Building and Management, (ICIBM 2011)*, Vol. 5, pp.295-299, IACSIT Press, Singapore, 02.-04. May, 2011.
- [48] Al-Daraiseh A., Shah N., El-Qawasmeh E., “*An Intelligent Energy Management System for Educational Buildings*,” *International Journal of Distributed Sensor Networks*, Vol. 2013, Article ID 209803, 13 pages, 2013.

- [49] Caffarel J., Jie S., Olloqui J, Martínez R., “Bat-MP: An ontology-based energy management platform,” *Ubiquitous Computing and Ambient Intelligence*, Springer, Lecture Notes in Computer Science, Vol. 7656, pp. 9-16, 2012.
- [50] Zhu H., van der Veldt K., Grosso P., Zhao Z., Liao X., de Laat C., Energy-aware semantic modeling in large scale infrastructures, *IEEE International Conference on Green Computing and Communications (GreenCom 2012)*, Besançon, France, 20.-23. November, 2012.
- [51] Tanasiev V., Badea A., “Energy efficiency through intelligent management of building equipment,” *UPB Scientific Bulletin. Series C. Electrical engineering and computer science*, Vol. 74, pp.49-56, Iss. 1, 2012
- [52] Wicaksono H., Rogalski S., *Ontology Supported Intelligent Energy Management System in Buildings*, *IEEE International Conference on Industrial Engineering and Business Management (ICIEBM)*, pp. 12-13, Yogyakarta, Indonesia, 12.-13. October, 2010,
- [53] Wicaksono H., Dobрева P., Häfner P, Rogalski S., *Ontology Development towards Expressive and Reasoning-enabled Building Information Model for an Intelligent Energy Management System*, *The 5th International Conference on Knowledge Engineering and Ontology Development*, Vilamoura, Portugal, 19.-22. September, 2013.
- [54] Dibley M.J., Li H., Miles J.C., Rezgui Y., “Towards intelligent agent based software for building related decision support,” *Advanced Engineering Informatics*, Vol. 25, Iss. 2, pp. 311-329, 2011.
- [55] Curry E., O’Donnell J., Corry E., Hasan S., Keane M., O’Riain S., “Linking building data in the cloud: Integrating cross-domain building data using linked data,” *Advanced Engineering Informatics*, Vol. 27, Iss. 2, pp. 206-219, 2013.
- [56] ISO 50001:2011. *Energy Management System - Requirements with guidance for use*, Genève, Switzerland, 2011.

-
- [57] Wang X., Dong J.S., Chin C.Y., Hettiarachchi S.R., Zhang D., “Semantic Space: An infrastructure for Smart Spaces,” IEEE Pervasive Computing, 3(3):32-39. Jul/Sep 2004.
- [58] Borst W., Construction of Engineering Ontologies. PhD thesis, Institute for Telematica and Information Technology, University of Twente, Enschede, Netherlands, 1997.
- [59] Hoekstra R., Ontology Representation: Design patterns and Ontologies that Make Sense, IOS Press BV, Amsterdam, Netherlands, 2009.
- [60] International Electrotechnical Commission (IEC) 61970: Common Information Model (CIM)/Energy Management, <http://www.iec.ch/smartgrid/standards/>
- [61] Aris L. Dimeas, and Nikos D. Hatziargyriou “Operation of a Multiagent System for Microgrid Control”, IEEE Transactions on Power Systems, Vol. 20, No. 3, August 2005
- [62] Groppe S., Data Management and Query Processing in Semantic Web Databases, ACM Computing Classification, Springer, 2011.
- [63] Knublauch H., Hendler H.A., Idehen K. (eds.), “SPIN - Overview and Motivation”, W3C Member Submission 22 February 2011, Available: <http://www.w3.org/Submission/2011/SUBM-spin-overview-20110222/>
- [64] Gearon P., Passant A., Polleres A. (eds.), “SPARQL 1.1 Update”, W3C Recommendation 21 March 2013, Available: <http://www.w3.org/TR/sparql11-update/>
- [65] Bizer C., Heath T., Berners-Lee T., “Linked Data - The Story So Far,” International Journal on Semantic Web and Information Systems, Vol. 5, Issue 3., pp.1-22, 2009.
- [66] Antoniou G., Boley H. (Eds.), Rules and Rule Markup Languages for the Semantic Web, The 3rd International Workshop (RuleML 2004), Springer, Lecture Notes in Computer Science, Vol. 3791, Hiroshima, Japan, 08. November 2004.

- [67] P. Favre-Perrod, M. Geidl, B. Klöckl and G. Koepfel, “A Vision of Future Energy Networks”, presented at the IEEE PES Inaugural Conference and Exposition in Africa, Durban, South Africa, 2005.
- [68] Groscurth H.-M., Bruckner Th., Kümmel R., “Modeling of energy-services supply systems,” *Energy*, Volume 20, Issue 9, September 1995, pp. 941–958.
- [69] Henning D., “MODEST - An energy system optimization model applicable to local utilities and countries,” *Energy*, Volume 22, Issue 12, December 1997, pp. 1135–1150.
- [70] Henning D., Amiri S., Holmgren K., “Modelling and optimisation of electricity, steam and district heating production for a local Swedish utility,” *European Journal of Operational Research*, Volume 175, Issue 2, 1 December 2006, pp. 1224–1247.
- [71] Kavvadias K.C., Tosios A.P., Maroulis Z.B., “Design of a combined heating, cooling and power system: Sizing, operation strategy selection and parametric analysis,” *Energy Conversion and Management*, Volume 51, Issue 4, April 2010, pp. 833–845.
- [72] Ortiga J., Bruno J.C., Coronas A., “Operational Optimisation of a Complex Trigeneration System Connected to a District Heating and Cooling Network,” *Applied Thermal Engineering*, Volume 50, Issue 2, February 2013, pp. 1536–1542.
- [73] Liu P, Pistikopoulos E.N., Li Z., “An energy systems engineering approach to the optimal design of energy systems in commercial buildings,” *Energy Policy*, Volume 38, Issue 8, August 2010, pp. 4224–4231.
- [74] Yokoyama R., Hasegawa Y., Ito K., “A MILP decomposition approach to large scale optimization in structural design of energy supply systems.” *Energy Conversion and Management*, Volume 43, Issue 6, April 2002, pp. 771–790.
- [75] Bakken B.H., Holen A.T., “Energy Service Systems: Integrated Planning Case Studies,” *IEEE Power Engineering Society General Meeting*, pp. 2068-2073, Volume 2, 10-10 June 2004, Denver, CO.

- [76] Bakken B.H., Skjelbred H.I., Wolfgang O., “eTransport: Investment Planning in Energy Supply Systems with Multiple Energy Carriers,” *Energy*, Volume 32, Issue 9, September 2007, pp. 1676–1689.
- [77] Hawkes A.D., Leach M.A., “Modelling high level system design and unit commitment for a microgrid,” *Applied Energy*, Volume 86, Issues 7–8, July–August 2009, pp. 1253–1265.
- [78] J. Vetterli, M. Benz, "Cost-optimal design of an ice-storage cooling system using mixed-integer linear programming techniques under various electricity tariff schemes, *Energy and Buildings*, Volume 49, Pages 226-234, 2012.
- [79] Khodra H.M., El Halabic N., García-Graciad M., "Intelligent renewable microgrid scheduling controlled by a virtual power producer: A laboratory experience," *Renewable Energy*, Vol. 48, pp. 269-275, 2012.
- [80] Ren H., Gao W., “A MILP model for integrated plan and evaluation of distributed energy systems,” *Applied Energy*, Volume 87, Issue 3, March 2010, pp. 1001–1014.
- [81] Mehleri E.D., Sarimveis H., Markatos N.C., Papageorgioub L.G., “Optimal Design and Operation of Distributed Energy Systems,” *Renewable Energy*, Volume 51, March 2013, pp. 331–342.
- [82] Mehleri E.D., Sarimveis H., Markatos N.C., Papageorgiou L.G., “A mathematical programming approach for optimal design of distributed energy systems at the neighbourhood level,” *Energy*, Volume 44, Issue 1, August 2012, pp. 96–104.
- [83] Pandzic H., Kuzle I., Capuder T., "Virtual power plant mid-term dispatch optimization," *Applied Energy*, Vol. 101, pp. 134-141, 2013.
- [84] Moraisa H., Kadarb P., Fariaa P., Valea Z.A., Khodra H.M., "Optimal scheduling of a renewable micro-grid in an isolated load area using mixed-integer linear programming," *Renewable Energy*, Vol. 35, Issue: 1, pp. 151-156, 2010.

- [85] Th. Schütz, R. Streblow, D. Müller, "A comparison of thermal energy storage models for building energy system optimization", *Energy and Buildings*, Volume 93, Pages 23-31, 2015.
- [86] Remme U., Goldstein G.A., Schellmann U., Schlenzig C., "MESAP/TIMES - Advanced Decision Support for Energy and Environmental Planning," *Operations Research Proceedings 2001 Volume 2001, 2002*, pp. 59-66.
- [87] Lin Q.G., Huang G.H., Bass B., Nie X.H., Zhang X.D., Qin X.S., "EMDSS: An optimization-based decision support system for energy systems management under changing climate conditions - An application to the Toronto-Niagara Region, Canada," *Expert Systems with Applications*, Volume 37, Issue 7, July 2010, pp. 5040–5051.
- [88] Manfren M., "Multi-commodity network flow models for dynamic energy management - Mathematical formulation," *Energy Procedia*, Volume 14, 2012, pp. 1380–1385.
- [89] Kung C.-H., Devaney M.J., Huang C.-M., Kung C.-M., "Power Source Scheduling and Adaptive Load Management Via a Genetic Algorithm Embedded Neural Network," *Proceedings of the 17th IEEE Instrumentation and Measurement Technology Conference, IMTC 2000*, Volume: 2, pp. 1061-1065, Baltimore, MD, May 2000.
- [90] Platt G., "Linking it All Together- An Intelligent Demand Side," *IEEE Energy 2030 Conference, ENERGY 2008*, pp. 1-4, Atlanta, GA, November 2008.
- [91] Cárdenas J.J., García A., Romeral J.L., Urresty J.C., "A Multi-Objective GA to Demand side Management in an Automated Warehouse," *14th IEEE International Conference on Emerging Technologies and Factory Automation*, pp. MD-002801, Mallorca, Spain September 2009.
- [92] Yao L., Chang W.-C., Yen R.-L., "An Iterative Deepening Genetic Algorithm for Scheduling of Direct Load Control," *IEEE Transactions on Power Systems*, Volume:20, Issue: 3, pp. 1414-1421, August 2005.

- [93] Mohsenian-Rad A.-H., Wong V.W.S., Jatskevich J., Schober R., Leon-Garcia A., "Autonomous Demand Side Management Based on Game-Theoretic Energy Consumption Scheduling for the Future Smart Grid," *IEEE Transactions on Smart Grid*, Volume:1, Issue: 3, pp. 320-331, December 2010.
- [94] Baharlouei Z., Hashemi M., Narimani H., Mohsenian-Rad H., "Achieving Optimality and Fairness in Autonomous Demand Response: Benchmarks and Billing Mechanisms," *IEEE Transactions on Smart Grid*, Volume: 4, Issue: 2, pp. 968 - 975, 2013.
- [95] A. Keshtkar, S. Arzanpour, F. Keshtkar, P. Ahmadi, "Smart residential load reduction via fuzzy logic, wireless sensors, and smart grid incentives", *Energy and Buildings*, Volume 104, Pages 165-180, 2015.
- [96] P. Mesarić, S. Krajcar, "Home demand side management integrated with electric vehicles and renewable energy sources", *Energy and Buildings*, Volume 108, Pages 1-9, 2015.
- [97] Henning D., "Cost minimization for a local utility through CHP, heat storage and load management," *International Journal of Energy Research*, Volume 22, Issue 8, 25 June 1998, pp. 691–713.
- [98] Kienzle F., Ahcin P, Andersson G. "Valuing Investments in Multi-Energy Conversion, Storage, and Demand Side Management Systems under Uncertainty", *IEEE Transaction on Sustainable Energy*, Vol. 2, No.2, April 2011.
- [99] Ahcin P., Sikic M. "Simulating demand response and energy storage in energy distribution systems", *Proceedings of the IEEE International Conference on Power System Technology*, Hangzhou, China, October 2010.
- [100] Sheikhi A., Rayati M., Bahrami,S., Ranjbar A.M. "Integrated Demand Side Management Game in Smart Energy Hubs", *IEEE Transactions on Smart Grid*, Vol. 6, No. 2, March 2015.

- [101] Almassalkhi M., Hiskens I.A. "[Optimization framework for the analysis of large-scale networks of energy hubs](#)". Proceedings of the Power Systems Computation Conference, Stockholm, August 2011.
- [102] F. Brahman , M. Honarmand , S. Jadid, "Optimal electrical and thermal energy management of a residential energy hub, integrating demand response and energy storage system", *Energy and Buildings*, Volume 90, Pages 65-75, 2015.
- [103] Beccuti G., Demiray T., Batic M., Tomasevic N. Vranes S., "Energy Hub Modelling and Optimisation: an Analytical Case Study", Proceedings of the Powertech Conference, Eindhoven, June 2015.
- [104] M.C. Bozchalui, S.A.Hashmi, H. Hassen, C.A. Cañizares, K. Bhattacharya "Optimal operation of residential energy hubs in smart grids", *IEEE Transactions on Smart Grid*, Vol. 3, No. 4, December 2012.
- [105] J. Khoury, R. Mbayed, G. Salloum, E. Monmasson, "Predictive demand side management of a residential house under intermittent primary energy source conditions," *Energy and Buildings*, pp. 110-120, 2016.
- [106] Maria Kouveletsou, Nikos Sakkas, Stephen Garvin, Marko Batic, Daniela Reccardo, Raymond Sterling, "Simulating energy use and energy pricing in buildings: The case of electricity," *Energy and Buildings*, Vol. 54, pp. 96-104, 2012.
- [107] Perrot, Pierre (1998). *A to Z of Thermodynamics*. Oxford University Press. ISBN 0-19-856552-6
- [108] Erbs DG, Klein SA, Duffie JA (1982), Estimation of the diffuse radiation fraction for hourly, daily, and monthly-average global radiation, *Solar Energy*,28, 293
- [109] WMO Guide to Meteorological Instruments and Methods of Observation WMO-No. 8 page I.5-13.
- [110] Manwell JF, McGowan JG (1993), Lead acid storage model for hybrid energy systems, *Solar Energy*,50, 399-405

- [111] Duffie, J.A. and Beckman, W.A. (1991) Solar Engineering of Thermal Processes. Wiley, Hoboken.
- [112] Sinha, S., Chandel, S.S., 'Review of software tools for hybrid renewable energy systems', Renewable and Sustainable Energy Reviews 32 (2014) 192-205
- [113] HOMER - Energy Modeling Software for Hybrid Renewable Energy Systems, <http://homerenergy.com/index.html>
- [114] EnergyPRO, Advanced energy system analysis computer model, <https://www.energyplan.eu/othertools/local/energypro/>
- [115] RETScreen, Natural Resources Canada, <http://www.etscreen.net/ang/home.php>
- [116] iHOGA - improved Hybrid Optimization by Genetic Algorithms, <http://www.unizar.es/rdufo/hoga-eng.htm>
- [117] Rajkumar Viral, D.K. Khatod, Optimal planning of distributed generation systems in distribution system: A review, Renewable and Sustainable Energy Reviews, Volume 16, Issue 7, 2012, Pages 5146-5165, ISSN 1364-0321, <https://doi.org/10.1016/j.rser.2012.05.020>.
- [118] L. Wang and C. Singh, "Multicriteria Design of Hybrid Power Generation Systems Based on a Modified Particle Swarm Optimization Algorithm," in IEEE Transactions on Energy Conversion, vol. 24, no. 1, pp. 163-172, March 2009. doi: 10.1109/TEC.2008.2005280
- [119] A. Hassan, M. Saadawi, M. Kandil and M. Saeed, "Modified particle swarm optimisation technique for optimal design of small renewable energy system supplying a specific load at Mansoura University," in IET Renewable Power Generation, vol. 9, no. 5, pp. 474-483, 7 2015. doi: 10.1049/iet-rpg.2014.0170
- [120] S. Singh and S. C. Kaushik, "Optimal sizing of grid integrated hybrid PV-biomass energy system using artificial bee colony algorithm," in IET Renewable Power Generation, vol. 10, no. 5, pp. 642-650, 5 2016. doi: 10.1049/iet-rpg.2015.0298

- [121] M. Alsayed, M. Cacciato, G. Scarcella and G. Scelba, "Multicriteria Optimal Sizing of Photovoltaic-Wind Turbine Grid Connected Systems," in *IEEE Transactions on Energy Conversion*, vol. 28, no. 2, pp. 370-379, June 2013. doi: 10.1109/TEC.2013.2245669
- [122] D. Arcos-Aviles, J. Pascual, L. Marroyo, P. Sanchis, F. Guinjoan and M. P. Marietta, "Optimal Fuzzy Logic EMS design for residential grid-connected microgrid with hybrid renewable generation and storage," 2015 IEEE 24th International Symposium on Industrial Electronics (ISIE), Buzios, 2015, pp. 742-747. doi:10.1109/ISIE.2015.7281561
- [123] S. J. Gunter, K. K. Afridi and D. J. Perreault, "Optimal Design of Grid-Connected PEV Charging Systems With Integrated Distributed Resources," in *IEEE Transactions on Smart Grid*, vol. 4, no. 2, pp. 956-967, June 2013. doi: 10.1109/TSG.2012.2227514
- [124] R. Atia and N. Yamada, "Sizing and Analysis of Renewable Energy and Battery Systems in Residential Microgrids," in *IEEE Transactions on Smart Grid*, vol. 7, no. 3, pp. 1204-1213, May 2016. doi: 10.1109/TSG.2016.2519541
- [125] M. Geidl and G. Andersson. A modeling and optimization approach for multiple energy carrier power flow. In *Proceedings of the IEEE PES PowerTech*, St. Petersburg, Russian Federation, July 2005.
- [126] M. Geidl, G. Koeppel, P. Favre-Perrod, B. Klockl, and G. Andersson. Energy hubs for the future. *Power and Energy Magazine*, 5(1), 2007.
- [127] M. Geidl and G. Andersson. Optimal coupling of energy infrastructures. In *Proceedings of the IEEE Powertech Conference*, Lausanne, Switzerland, July 2007.
- [128] E. Fabrizio, V. Corrado, and M. Filippi. A model to design and optimize multi-energy systems in buildings at the design concept stage. *Renewable Energy*, 35, 2010.

- [129] E. Fabrizio, M. Filippi, and J. Virgone. An hourly modelling framework for the assessment of energy sources exploitation and energy converters selection and sizing in buildings. *Energy and Buildings*, 41, 2009.
- [130] A. Parisio, C. Del Vecchio, and A. Vaccaro. A robust optimization approach to energy hub management. *International Journal of Electrical Power and Energy Systems*, 42, 2012.
- [131] A. Ben-Tal and A. Nemirovski. Robust solutions of uncertain linear programs. *Operations research letters*, 25, 1999.
- [132] A. Ashouri, S. Fux, M Benz, and L Guzzella. Optimal design and operation of building services using mixed-integer linear programming techniques. *Energy*, 2013.
- [133] B. Kalitventzeff and F. Marachal. Process integration: selection of the optimal utility system. *Computers and Chemical Engineering* , 22, 1998.
- [134] S. Fazlollahi and F. Marechal. Multi-objective, multi-period optimization of biomass conversion technologies using evolutionary algorithms and mixed integer linear programming . *Applied Thermal Engineering*, 50, 2013.
- [135] M. Almassalkhi and I.A. Hiskens. Optimization framework for the analysis of large-scale networks of energy hubs. In *Proceedings of the 17th Power Systems Computation Conference*, Stockholm, Sweden, August 2011.
- [136] L.G. Swan, V.I. Ugursal, Modeling of end-use energy consumption in the residential sector: a review of modeling techniques, *Renewable and Sustainable Energy Reviews* 13 (2009) 1819–1835.
- [137] Z.J. Zhai, Q.Y. Chen, Performance of coupled building energy and CFD simulations, *Energy and Buildings* 37 (2005) 333–344.
- [138] Z. Zhai, Application of computational fluid dynamics in building design: aspects and trends, *Indoor and Built Environment* 15 (2006) 305–313.

- [139] Directive 2002/91/EC of the European Parliament and of the Council of 16 December 2002 on the Energy Performance of Buildings, 4.1.2003 EN Official Journal of the European Communities, Part L.
- [140] European Commission, Directorate-General for Energy and Transport, Energy Efficiency in Buildings, 2012, http://ec.europa.eu/energy/efficiency/buildings/standardisation_en.htm (accessed 03.06.12).
- [141] Energy Warden Project Official Website, 2012, www.energywarden.net (accessed 10.05.12).
- [142] R. Yao, K. Steemers, A method of formulating energy load profile for domestic buildings in the UK, *Energy and Buildings* 37 (2005) 663–671.
- [143] N. Fumo, P. Mago, R. Luck, Methodology to estimate building energy consumption using EnergyPlus Benchmark Models, *Energy and Buildings* 42 (2010) 2331–2337.
- [144] I. Knight, N. Kreutzer, M. Maaning, M. Swinton, H. Ribberink, European and Canadian non-HVAC electric and DHW load profiles for use in simulating the performance of residential cogeneration systems, A report of subtask A of FC + COGEN-SIM, Annex 42 of the International Energy Agency, Energy Conservation in Buildings and Community Systems Programme, 2007.
- [145] Brans JP, Vincke P. Note—A Preference Ranking Organisation Method: (The PROMETHEE Method for Multiple Criteria Decision-Making). *Management science*. 1985 Jun;31(6):647-56.
- [146] P. Hoes, J.L.M. Hensen, M.G.L.C. Loomans, B. de Vries, D. Bourgeois, User behaviour in whole building simulation, *Energy and Buildings* 41 (2009) 295–302.
- [147] O. Guerra Santin, Behavioural patterns and user profiles related to energy consumption for heating, *Energy and Buildings* 43 (2011) 2662–2672.
- [148] J. Seryak, K. Kissock, Occupancy and behavioral affects on residential energy use, in: American Solar Energy Society Solar conference, Austin, TX, 2003.

- [149] Load Shifting in Response to Time-of-Day Pricing in POEMS, Prepared for the National Energy Renewable Energy Laboratory, 2000.
- [150] Keane M., Costa A., Blanes L., Donnelly C., Torrens I., Monaghan P., Brogan M., McCaffrey M., CASCADE ICT for Energy Efficient Airports, Project Deliverable D2.1 – “CASCADE Methodology for Energy Efficient Airports”, 2012.
- [151] DESIGO building automation system, Siemens, <http://www.buildingtechnologies.siemens.com/>
- [152] Muller T., Rist T., Rehault N., Cara E., Luginsland F., Reetz C., Costa A., Blanes L., Keane M., Tomasevic N., CASCADE ICT for Energy Efficient Airports, Project Deliverable D4.2 – “Integrated ICT Supported Automated Fault Detection and Diagnosis”, 2013.
- [153] Müller T., Kruppa K., Lichtenberg G., Réhault N., “Fault Detection with Qualitative Models reduced by Tensor Decomposition methods,” unpublished conference paper to be presented at: 9th IFAC Symposium on Fault Detection, Supervision and Safety for Technical Processes, Paris, 2.-4. September, 2015.
- [154] ISO 50001:2011. Energy Management System - Requirements with guidance for use, Genève, Switzerland, 2011.
- [155] Dorr M., Wahren S., Bauernhansl T., Methodology for energy efficiency on process level, The 46th Conference on Manufacturing Systems (CIRP CMS 2013), Vol. 7, pp. 652 – 657, Setubal, Portugal, 29.-30. May, 2013.
- [156] R. Stamatović, A. Car, “Analiza proizvodnje krovne fotonaponske elektrane”, 32nd CIGRE Serbia counseling, 17th-21st of May, Zlatibor, Serbia (in Serbian). Available at: https://www.researchgate.net/publication/277018319_Analiza_proizvodnje_krovne_fotonaponske_elektrane
- [157] The Institute Mihajlo Pupin, Official Web site, News section. Available at: <http://www.pupin.rs/en/2013/11/photovoltaic-power-station-opened-in-mihajlo-pupin-institute/>

- [158] J. Khoury, R. Mbayed, G. Salloum, E. Monmasson, “Predictive demand side management of a residential house under intermittent primary energy source conditions,” *Energy and Buildings*, pp. 110-120, 2016.
- [159] Maria Kouveletsou, Nikos Sakkas, Stephen Garvin, Marko Batic, Daniela Reccardo, Raymond Sterling, “Simulating energy use and energy pricing in buildings: The case of electricity,” *Energy and Buildings*, Vol. 54, pp. 96-104, 2012.
- [160] ISO 50001:2011. Energy Management System - Requirements with guidance for use, Genève, Switzerland, 2011.
- [161] Dorr M., Wahren S., Bauernhansl T., Methodology for energy efficiency on process level, The 46th Conference on Manufacturing Systems (CIRP CMS 2013), Vol. 7, pp. 652 – 657, Setubal, Portugal, 29.-30. May, 2013.
- [162] ISO 7730. Ergonomics of the thermal environment analytical determination and interpretation of thermal comfort using the PMV and PPD indices and local thermal comfort criteria 2005.
- [163] CPLEX Optimizer - High-performance mathematical programming solver for linear, mixed integer and quadratic programming, <http://www-01.ibm.com/software/commerce/optimization/cplex-optimizer/>

Appendices

Appendix I: Ontology API for local access

Technical characterization and semantic interpretation of signals

```
// SPARQL Query
```

```
queryStr.append("SELECT ?power ?areaID ?sysID ?devID ?compID "+
    "FROM <http://localhost:8890/OntologyTesting> "+
    "WHERE { "+
    "    ?srdf:typepref:pvPanel. " +
    "    ?spref:device_id \"" + deviceID + "\"^^xsd:string. " +
    "    ?spref:outputPower_kW ?power. " +
    "    ?spref:locatedAt_area ?area. " +
    "    ?areapref:area_id ?areaID. " +
    "    ?spref:partOf_system ?system. " +
    "    ?systempref:system_id ?sysID. " +
    "    ?spref:connectedTo ?connectedToDevice. " +
    "    ?connectedToDevicepref:device_id ?devID. " +
    "    ?spref:connectedTo ?connectedToComp. " +
    "    ?connectedToCompref:component_id ?compID. " +
    "}")
```

```
Query query=QueryFactory.create(queryStr.toString());
QueryExecutionqe=QueryExecutionFactory.create(query,model);
```

Updating the knowledge base repository

```
// SPARQL Update - To replace a property first delete current value and then
insert new one
```

```
queryStr.append("DELETE { " +
    "    ?spref:stateOfCharge_% ?o. " +
    "    } " +
    "WHERE { " +
    "    ?spref:device_id \"" + id + "\"^^xsd:string. " +
    "    ?spref:stateOfCharge_% ?o. " +
    "    } " +
    "INSERT { " +
    "    ?spref:stateOfCharge_% \"" + flow + "\"^^xsd:float. " +
    "    } " +
    "WHERE { " +
    "    ?srdf:typepref:batteryStorage. " +
    "    ?spref:device_id \"" + id + "\"^^xsd:string. " +
    "    }"}");
```

```
// Update execution
```

```
UpdateAction.parseExecute(queryStr.toString(),model);
```

Applying a generic inference engine

```
PrintUtil.registerPrefix("pref",this.defaultNameSpace);
```

```
String ruleSrc="[rule1: (?xpref:partOf_device ?y) (?y pref:partOf_system ?z) -> (?x pref:partOf_system ?z)]";
```

```
GenericRuleReasonerreasoner=
```

```
newGenericRuleReasoner(Rule.parseRules(ruleSrc));
```

```
InfModelinf=ModelFactory.createInfModel(reasoner, model);
```

Appendix II: Ontology API for remote access

SPARQL Query (Jena)

```
// SPARQL Query
queryStr.append("DELETE FROM <http://localhost:8890/OntologyTesting> " +
    "{ ?s pref:generationPower_kw ?o. } " +
    "WHERE { " +
    "?spref:device_id \"" + deviceID + "\"^^xsd:string. " +
    "?spref:generationPower_kw ?o. " +
    "}" +
    "INSERT INTO <http://localhost:8890/OntologyTesting> " +
    "{ ?s pref:generationPower_kw \"" + power + "\"^^xsd:float. } " +
    "WHERE { " +
    "?srdf:typepref:pvPanel. " +
    "?spref:device_id \"" + deviceID + "\"^^xsd:string. }");
```

```
String queryStr="query="+URLEncoder.encode(query,"UTF-8");
StringBuffersb=newStringBuffer();
try{
    String queryString="query="+URLEncoder.encode(queryStr,"UTF-8");

    HttpURLConnection conn =null;
    //String type = "text/plain";

    URL url=newURL("http://fraunhofer2.imp.bg.ac.rs/sparql");
    conn=(HttpURLConnection)url.openConnection();

    conn.setRequestMethod("POST");
    conn.setDoOutput(true);

    OutputStreamWriters=newOutputStreamWriter(conn.getOutputStream());
    os.write(queryStr);
    os.flush();
    os.close();

    // Get the response
    BufferedReaderrd=new BufferedReader(
    new InputStreamReader(conn.getInputStream()));
    String line;
    String NL =System.getProperty("line.separator");
    while((line =rd.readLine())!=null){
        sb.append(line + NL);
    }
    rd.close();
}catch(Exception e){
    e.printStackTrace();
}
return sb.toString();
```

SPARQL Query (HTTP)

```
String service ="http://fraunhofer2.imp.bg.ac.rs/sparql";
// SPARQL Query
queryStr -> the same as for the locally stored ontology.
String query =queryStr.toString();
QueryExecutionqe=QueryExecutionFactory.sparqlService(service, query);
```

SPARQL Update

```
URL url=newURL("http://user:pass@fraunhofer2.imp.bg.ac.rs/sparql-
auth");
```

Author biography

Marko Batic was born on November 6, 1985. in Belgrade. He has finished the Mathematical Grammar School in Belgrade in 2004. Afterwards, the started the undergraduate studies at the School of Electrical Engineering, Univeristy of Belgrade, and he graduated from the Department of Telecommunications and Information Technologies in 2008. In the same year, he enrolled master studies at the same Department under the module System Engineering and Radio Communications, which he then completed in early 2010. At the end of the 2010, he enrolled PhD studies at the School of Electrical Engineering, University of Belgrade, module: Software Engineering, under the supervision of Prof. dr Sanja Vraneš.

During the course of the master studies, he started working at the Institute Mihajlo Pupin, at the Department for intelligent systems, led by the General Director of the Institute Prof. dr Sanja Vraneš. His research interests include simulation and optimisation of renewable energy sources, decision support systems, and semantic web. He was actively involved in 3 Fp7 research projects funded by EU and 1 funded by the Serbian Ministry of Education, Science and Technological development. He is currently involved in 2 H2020 research projects by EU. During his PhD studies, he published 3 papers in leading international journals and made over 15 contributions to conferences and workshops. He serves as a reviewer for respectable international journals (e.g. Energy Convers. Manag, Applied Eng.). Moreover, in 2017 he was hired as an external expert for the European Commission for the evaluation of proposals in an H2020-LCE Call.

Изјава о ауторству

Име и презиме аутора : Марко Батић

Број индекса: 5035/2010

Изјављујем

да је докторска дисертација под насловом:

Software system for multi-criteria planning and operation of hybrid microgrids

**Софтверски систем за више-критеријумско планирање и управљање
хибридном микро-мрежом**

-
- резултат сопственог истраживачког рада;
 - да дисертација у целини ни у деловима није била предложена за стицање друге дипломе према студијским програмима других високошколских установа;
 - да су резултати коректно наведени и
 - да нисам кршио/ла ауторска права и користио/ла интелектуалну својину других лица.

Потпис аутора

У Београду, 11. 01. 2019.



Изјава о истоветности штампане и електронске верзије докторског рада

Име и презиме аутора: **Марко Батић**

Број индекса: **5035/2010**

Студијски програм: **Софтверско инжењерство**

Наслов рада: **Software system for multi-criteria planning and operation of hybrid microgrids**

(Софтверски систем за више-критеријумско планирање и управљање хибридном микро-мрежом)

Ментор: **Проф. др Сања Вранеш**

Изјављујем да је штампана верзија мог докторског рада истоветна електронској верзији коју сам предао/ла ради похрањена у **Дигиталном репозиторијуму Универзитета у Београду**.

Дозвољавам да се објаве моји лични подаци везани за добијање академског назива доктора наука, као што су име и презиме, година и место рођења и датум одбране рада.

Ови лични подаци могу се објавити на мрежним страницама дигиталне библиотеке, у електронском каталогу и у публикацијама Универзитета у Београду.

Потпис аутора

У Београду, 11. 01. 2019.



Изјава о коришћењу

Овлашћујем Универзитетску библиотеку „Светозар Марковић“ да у Дигитални репозиторијум Универзитета у Београду унесе моју докторску дисертацију под насловом:

Software system for multi-criteria planning and operation of hybrid microgrids

Софтверски систем за више-критеријумско планирање и управљање хибридном микро-мрежом

која је моје ауторско дело.

Дисертацију са свим прилозима предао/ла сам у електронском формату погодном за трајно архивирање.

Моју докторску дисертацију похрањену у Дигиталном репозиторијуму Универзитета у Београду и доступну у отвореном приступу могу да користе сви који поштују одредбе садржане у одабраном типу лиценце Креативне заједнице (Creative Commons) за коју сам се одлучио/ла.

1. Ауторство (CC BY)

2. Ауторство – некомерцијално (CC BY-NC)

3. Ауторство – некомерцијално – без прерада (CC BY-NC-ND)

4. Ауторство – некомерцијално – делити под истим условима (CC BY-NC-SA)

5. Ауторство – без прерада (CC BY-ND)

6. Ауторство – делити под истим условима (CC BY-SA)

(Молимо да заокружите само једну од шест понуђених лиценци.
Кратак опис лиценци је саставни део ове изјаве).

Потпис аутора

У Београду, 11.01.2019.



1. **Ауторство.** Дозвољаваате умножавање, дистрибуцију и јавно саопштавање дела, и прераде, ако се наведе име аутора на начин одређен од стране аутора или даваоца лиценце, чак и у комерцијалне сврхе. Ово је најслободнија од свих лиценци.

2. **Ауторство – некомерцијално.** Дозвољаваате умножавање, дистрибуцију и јавно саопштавање дела, и прераде, ако се наведе име аутора на начин одређен од стране аутора или даваоца лиценце. Ова лиценца не дозвољава комерцијалну употребу дела.

3. **Ауторство – некомерцијално – без прерада.** Дозвољаваате умножавање, дистрибуцију и јавно саопштавање дела, без промена, преобликовања или употребе дела у свом делу, ако се наведе име аутора на начин одређен од стране аутора или даваоца лиценце. Ова лиценца не дозвољава комерцијалну употребу дела. У односу на све остале лиценце, овом лиценцом се ограничава највећи обим права коришћења дела.

4. **Ауторство – некомерцијално – делити под истим условима.** Дозвољаваате умножавање, дистрибуцију и јавно саопштавање дела, и прераде, ако се наведе име аутора на начин одређен од стране аутора или даваоца лиценце и ако се прерада дистрибуира под истом или сличном лиценцом. Ова лиценца не дозвољава комерцијалну употребу дела и прерада.

5. **Ауторство – без прерада.** Дозвољаваате умножавање, дистрибуцију и јавно саопштавање дела, без промена, преобликовања или употребе дела у свом делу, ако се наведе име аутора на начин одређен од стране аутора или даваоца лиценце. Ова лиценца дозвољава комерцијалну употребу дела.

6. **Ауторство – делити под истим условима.** Дозвољаваате умножавање, дистрибуцију и јавно саопштавање дела, и прераде, ако се наведе име аутора на начин одређен од стране аутора или даваоца лиценце и ако се прерада дистрибуира под истом или сличном лиценцом. Ова лиценца дозвољава комерцијалну употребу дела и прерада. Слична је софтверским лиценцама, односно лиценцама отвореног кода.